

Serrated Hard
Top Jaws

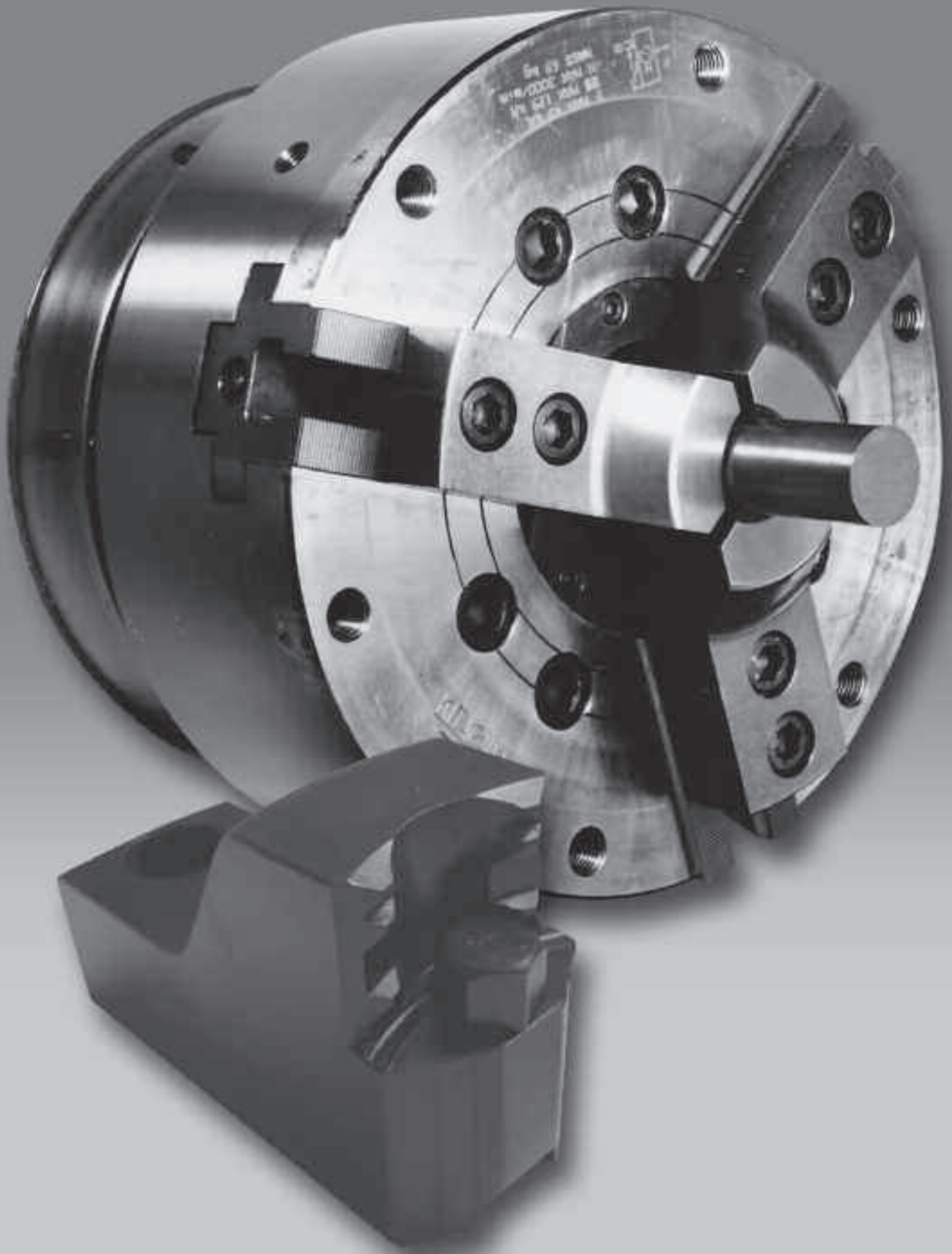

Serrated Hard Top Jaws

Page

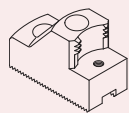

Adjustagrip Hard Jaws

- External clamping
- 60° serrations
- 90° serrations

45 - 89

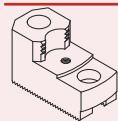

Adjustagrip Hard Jaws

- Internal clamping
- 60° serrations
- 90° serrations

45 - 89

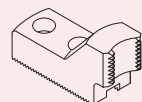

Adjustagrip Bar Jaws

- Bar clamping
- 60° serrations
- 90° serrations

45 - 89



Hard Reversible Jaws

- 2 or 3 step
- 60° serrations
- 90° serrations

90 - 103

Serrated Hard Top Jaws

	External Grip Adjustagrip 60° Serrations	Internal Grip Adjustagrip 60° Serrations	Bar Gripping Adjustagrip 60° Serrations	External Grip Adjustagrip 90° Serration	Internal Grip Adjustagrip 90° Serration	Bar Gripping Adjustagrip 90° Serration	Hard Reversible Jaws
	Page	Page	Page	Page	Page	Page	Page
AUTOBLOK							100-101
AUTOSTRONG	45-47	45-47	45-47				90-91, 94-95
BERG				77			99, 100-101
FORKARDT				78-82	78-82	78-82	99, 100-101
HARDINGE							90-91, 94-95
HOWA	48	48	48				90-91, 94-95, 98
KITAGAWA	49-54	49-54	49-54				90-91, 94-95
LEADER							90-91, 94-95
MMK MATSUMOTO	55-57	55-57	55-57				98
PRATT BURNERD	58-60	58-60	58-60				90-91, 94-95, 102-103
RÖHM				83-84	83-84	83-84	92-93, 96-97, 102-103
SAMCHULLY	61-63	61-63	61-63				92-93, 96-97
SCHUNK	64-67	64-67	64-67	85-88	85-88	85-88	92-93, 96-97, 102-103
SEOAM	68-69	68-69	68-69				92-93, 96-97
SMW							102-103
SMW-AUTOBLOK	70-73	70-73	70-73	89	89	89	92-93, 96-97, 100-101
TONFOU	74-76	74-76	74-76				92-93, 96-97

Adjustagrip Hard Top Jaws

Adjustagrip hard jaws are designed to provide maximum grip during 1st operation workholding applications- these jaws allow increased feed rates, depth of cut and reduce cycle times, compared to using standard hard reversible or soft jaws.

Ideal for rough castings and raw stock material.

Serrated Hard
Top Jaws



- The serious Hard Jaws for heavy machining.
- One set will grip various gripping diameters
- Clamping depth varied by a range of height pins
- Six Radial gripping teeth per jaw for high transmission and greater safety
- Lightweight design allows higher RPM's giving more grip
- Made with alloy steel for strength and durability
- External or Internal Gripping styles & Bar Jaws available
- Proven product over 20 years in the market
- Stock or short delivery for standard ranges

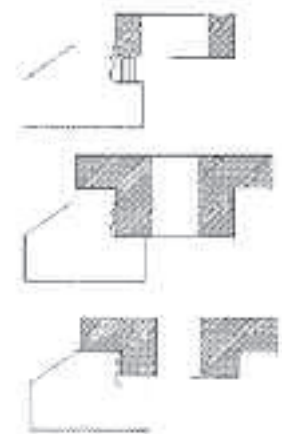
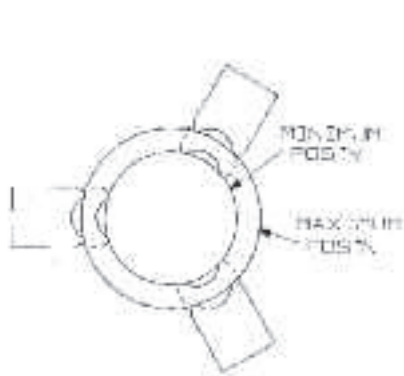
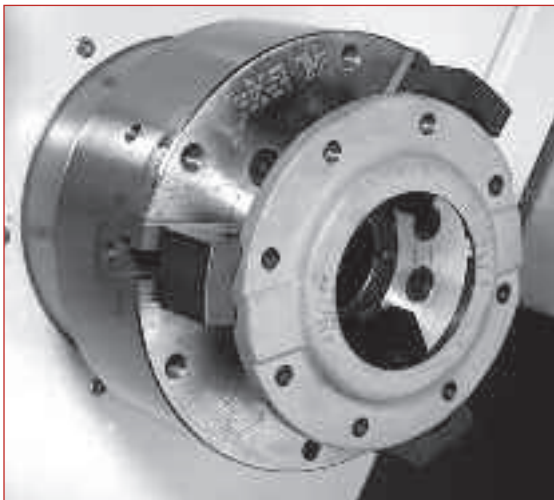

Adjustagrip Hard Top Jaws

To suit Power Chucks
60° SERRATIONS

Material:

- Steel: 590M17

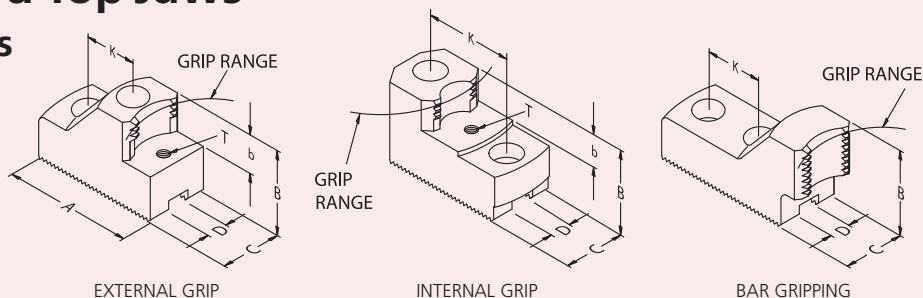

Serrated Hard Top Jaws

To suit • Auto-Strong Chuck Series N-200

CHUCK Ø	TYPE	EXTERNAL GRIP RANGES	EXTERNAL GRIP JAW PART No	INTERNAL GRIP RANGES	INTERNAL GRIP JAW PART No	B	C	D	K	b	T	SERRATION
169	N-206	14 - 31	KK 16 (Bar Jaw)			39	35	12	20			1.5mm x 60°
		27 - 44	LA 03	46 - 66	MA 05	49	35	12	20	20	M6	
		40 - 64	LA 04	53 - 77	MA 06							
		54 - 78	LA 06	71 - 97	MA 07							
		68 - 93	LA 07	94 - 119	MA 09							
		84 - 109	LA 09									
210	N-208	18 - 44	KK 20 (Bar Jaw)			49	40	14	25			1.5mm x 60°
		39 - 67	LB 03	57 - 85	MB 06	49	40	14	25	20	M6	
		67 - 95	LB 06	85 - 118	MB 08							
		95 - 124	LB 09	118 - 150	MB 11							
		123 - 151	LB 12	148 - 178	MB 14							
254	N-210	29 - 63	KK 25 (Bar Jaw)			49	40	16	30			1.5mm x 60°
		48 - 86	LC 04	65 - 104	MC 06	59	40	16	30	25	M8	
		86 - 129	LC 08	104 - 145	MC 10							
		129 - 172	LC 13	145 - 185	MC 14							
		172 - 215	LC 17	185 - 222	MC 18							
304	N-212	33 - 86	KK 33 (Bar Jaw)			49	50	21	30			1.5mm x 60°
		55 - 110	LE 05	86 - 149	ME 08	59	50	21	30	25	M8	
		109 - 172	LE 10	149 - 207	ME 14							
		172 - 237	LE 16	207 - 270	ME 20							
		239 - 300	LE 23	269 - 330	ME 26							

Workpiece Height Pins

See page 165



Adjustagrip Jaws are available on request in special sizes or to suit other chuck types.

Adjustagrip Hard Top Jaws

To suit Power Chucks
60° SERRATIONS

Material:

- Steel: 590M17

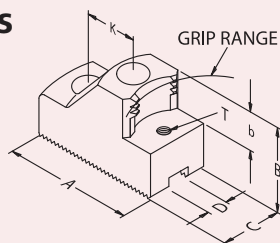

EXTERNAL GRIP

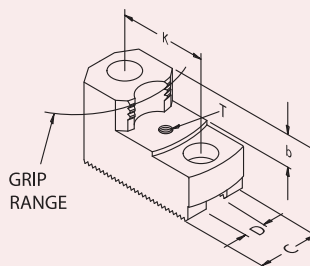

INTERNAL GRIP

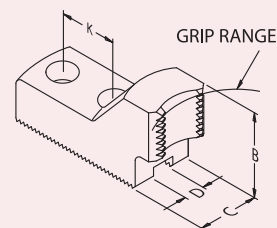

BAR GRIPPING

To suit • Auto-Strong Chuck Series NB-200A

CHUCK Ø	TYPE	EXTERNAL GRIP RANGES	EXTERNAL GRIP JAW PART No	INTERNAL GRIP RANGES	INTERNAL GRIP JAW PART No	B	C	D	K	b	T	SERRATION
170	NB-206	14 - 26	KK 16 (Bar Jaw)			39	35	12	20			1.5mm x 60°
		27 - 44	LA 03	46 - 62	MA 05	49	35	12	20	20	M6	
		44 - 60	LA 04	57 - 76	MA 06							
		58 - 74	LA 06	76 - 95	MA 07							
		72 - 89	LA 07	98 - 115	MA 09							
		89 - 105	LA 09									
210	NB-208	25 - 46	KK 20 (Bar Jaw)			49	40	14	25			1.5mm x 60°
		47 - 75	LB 03	64 - 93	MB 06	49	40	14	25	20	M6	
		75 - 103	LB 06	93 - 123	MB 08							
		103 - 131	LB 09	126 - 155	MB 11							
		130 - 156	LB 12	155 - 184	MB 14							
254	NB-210	32 - 67	KK 25 (Bar Jaw)			49	40	16	30			1.5mm x 60°
		52 - 90	LC 04	69 - 108	MC 06	59	40	16	30	25	M8	
		90 - 133	LC 08	108 - 148	MC 10							
		133 - 176	LC 13	149 - 190	MC 14							
		176 - 216	LC 17	188 - 230	MC 18							
315	NB-212	59 - 103	KK 33 (Bar Jaw)			49	50	21	30			1.5mm x 60°
		83 - 130	LE 05	115 - 164	ME 08	59	50	21	30	25	M8	
		137 - 187	LE 10	178 - 229	ME 14							
		202 - 252	LE 16	237 - 288	ME 20							
		269 - 320	LE 23	299 - 350	ME 26							

Workpiece Height Pins



See page 165

Adjustagrip Jaws are available on request in special sizes or to suit other chuck types.

Adjustagrip Hard Top Jaws

To suit Power Chucks
60° SERRATIONS

Material:

- Steel: 590M17

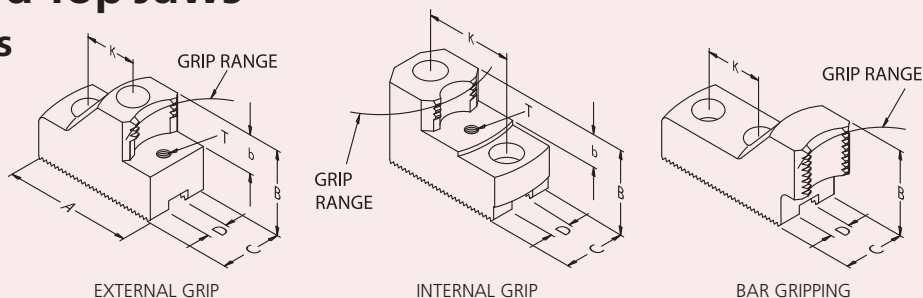

Serrated Hard Top Jaws

To suit • Auto-Strong Chuck Series V

CHUCK Ø	TYPE	EXTERNAL GRIP RANGES	EXTERNAL GRIP JAW PART No	INTERNAL GRIP RANGES	INTERNAL GRIP JAW PART No	B	C	D	K	b	T	SERRATION
165	V-206	17 - 27	KK 16 (Bar Jaw)			39	35	12	20			1.5mm x 60°
		31 - 45	LA 03	52 - 63	MA 05	49	35	12	20	20	M6	
		50 - 65	LA 04	63 - 78	MA 06							
		64 - 79	LA 06	82 - 98	MA 07							
		79 - 94	LA 07	104 - 116	MA 09							
		94 - 110	LA 09									
210	V-208	25 - 44	KK 20 (Bar Jaw)			49	40	14	25			1.5mm x 60°
		48 - 72	LB 03	65 - 90	MB 06	49	40	14	25	20	M6	
		75 - 100	LB 06	94 - 120	MB 08							
		104 - 130	LB 09	127 - 153	MB 11							
		131 - 155	LB 12	156 - 180	MB 14							
254	V-210	25 - 58	KK 25 (Bar Jaw)			49	40	16	30			1.5mm x 60°
		44 - 80	LC 04	60 - 99	MC 06	59	40	16	30	25	M8	
		80 - 123	LC 08	99 - 139	MC 10							
		123 - 166	LC 13	139 - 180	MC 14							
		166 - 205	LC 17	179 - 220	MC 18							
304	V-212	28 - 91	KK 32 (Bar Jaw)			49	50	18	30			1.5mm x 60°
		54 - 120	LD 05	82 - 151	MD 08	59	50	18	30	25	M8	
		111 - 179	LD 11	143 - 213	MD 14							
		175 - 244	LD 17	204 - 274	MD 20							
		237 - 308	LD 23	261 - 332								

Adjustagrip Jaws are available on request in special sizes or to suit other chuck types.

Adjustagrip Hard Top Jaws

To suit Power Chucks
60° SERRATIONS

Material:

- Steel: 590M17

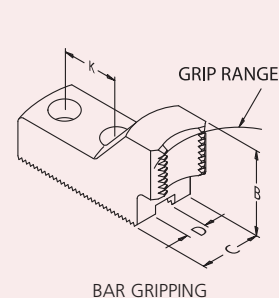
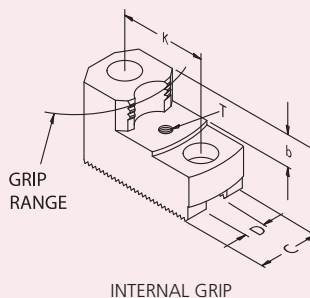
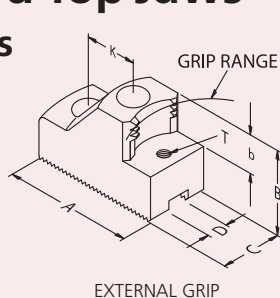

To suit • Howa Chuck Series H3KT

CHUCK Ø	TYPE	EXTERNAL GRIP RANGES	EXTERNAL GRIP JAW PART No	INTERNAL GRIP RANGES	INTERNAL GRIP JAW PART No	B	C	D	K	b	T	SERRATION
169	H3KT06	14 - 31	KK 16 (Bar Jaw)			39	35	12	20			1.5mm x 60°
		27 - 45	LA 03	45 - 66	MA 05	49	35	12	20	20	M6	
		40 - 64	LA 04	52 - 77	MA 06							
		54 - 79	LA 06	70 - 97	MA 07							
		68 - 93	LA 07	93 - 119	MA 09							
		84 - 110	LA 09									
210	H3KT08	18 - 45	KK 20 (Bar Jaw)			49	40	14	25			1.5mm x 60°
		39 - 68	LB 03	56 - 84	MB 06	49	40	14	25	20	M6	
		68 - 95	LB 06	85 - 114	MB 08							
		95 - 124	LB 09	118 - 147	MB 11							
123 - 152	LB 12	147 - 177	MB 14									
254	H3KT10	29 - 64	KK 25 (Bar Jaw)			49	40	16	30			1.5mm x 60°
		48 - 86	LC 04	64 - 103	MC 06	59	40	16	30	25	M8	
		86 - 129	LC 08	103 - 144	MC 10							
		129 - 172	LC 13	144 - 186	MC 14							
172 - 211	LC 17	184 - 225	MC 18									
304	H3KT12	33 - 87	KK 33 (Bar Jaw)			49	50	21	30			1.5mm x 60°
		55 - 111	LE 05	85 - 149	ME 08	59	50	21	30	25	M8	
		109 - 172	LE 10	149 - 210	ME 14							
		172 - 239	LE 16	207 - 270	ME 20							
239 - 305	LE 23	269 - 330	ME 26									

Adjustagrip Jaws are available on request in special sizes or to suit other chuck types.

Adjustagrip Hard Top Jaws

To suit Power Chucks
60° SERRATIONS

Material:

- Steel: 590M17

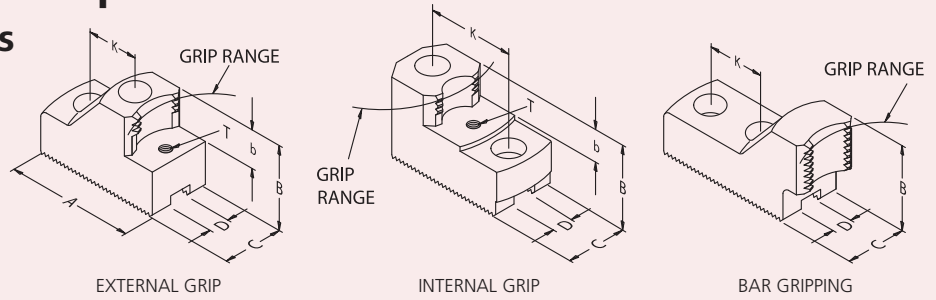

Serrated Hard Top Jaws

To suit • Kitagawa Chuck Series B200

CHUCK Ø	TYPE	EXTERNAL GRIP RANGES	EXTERNAL GRIP JAW PART No	INTERNAL GRIP RANGES	INTERNAL GRIP JAW PART No	B	C	D	K	b	T	SERRATION
169	B206	13 - 33	KK 16 (Bar Jaw)			39	35	12	20			1.5mm x 60°
		26 - 47	LA 03	45 - 69	MA 05	49	35	12	20	20	M6	
		37 - 67	LA 04	49 - 80	MA 06							
		50 - 81	LA 06	68 - 99	MA 07							
		64 - 96	LA 07	90 - 122	MA 09							
		80 - 112	LA 09									
210	B208	16 - 45	KK 20 (Bar Jaw)			49	40	14	25			1.5mm x 60°
		31 - 68	LB 03	50 - 85	MB 06	49	40	14	25	20	M6	
		60 - 96	LB 06	78 - 115	MB 08							
		87 - 125	LB 09	110 - 148	MB 11							
		114 - 152	LB 12	139 - 178	MB 14							
254	B210	25 - 65	KK 25 (Bar Jaw)			49	40	16	30			1.5mm x 60°
		44 - 85	LC 04	61 - 103	MC 06	59	40	16	30	25	M8	
		82 - 125	LC 08	100 - 143	MC 10							
		125 - 169	LC 13	140 - 185	MC 14							
		168 - 212	LC 17	180 - 224	MC 18							
304	B212	27 - 88	KK 33 (Bar Jaw)			49	50	21	30			1.5mm x 60°
		48 - 112	LE 05	78 - 145	ME 08	59	50	21	30	25	M8	
		102 - 168	LE 10	142 - 209	ME 14							
		165 - 233	LE 16	201 - 269	ME 20							
		232 - 300	LE 23									

Workpiece Height Pins

See page 165



Adjustagrip Jaws are available on request in special sizes or to suit other chuck types.

Adjustagrip Hard Top Jaws

To suit Power Chucks
60° SERRATIONS

Material:

- Steel: 590M17

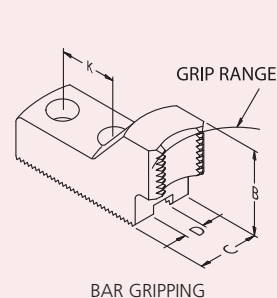
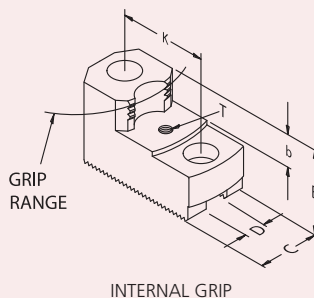
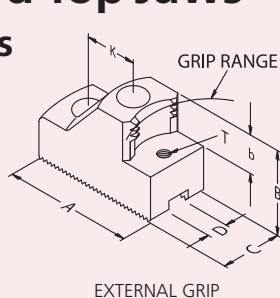

To suit • Kitagawa Chuck Series B/BA/HOH

CHUCK Ø	TYPE	EXTERNAL GRIP RANGES	EXTERNAL GRIP JAW PART No	INTERNAL GRIP RANGES	INTERNAL GRIP JAW PART No	B	C	D	K	b	T	SERRATION
165	B-06	13 - 29	KK 16 (Bar Jaw)			39	35	12	20			1.5mm x 60°
	HOH-206	31 - 62	LA 04	47 - 76	MA 06	49	35	12	20	20	M6	
		50 - 77	LA 06	67 - 95	MA 07							
		64 - 91	LA 07	83 - 117	MA 09							
		73 - 108	LA 09									
210	B-08	16 - 41	KK 20 (Bar Jaw)			49	40	14	25			1.5mm x 60°
	HOH-208	25 - 65	LB 03	50 - 82	MB 06	49	40	14	25	20	M6	
		54 - 93	LB 06	72 - 112	MB 08							
		81 - 121	LB 09	104 - 145	MB 11							
		108 - 149	LB 12	133 - 174	MB 14							
254	B-10	23 - 62	KK 25 (Bar Jaw)			49	40	16	30			1.5mm x 60°
	HOH-10K	41 - 81	LC 04	57 - 100	MC 06	59	40	16	30	25	M8	
		78 - 121	LC 08	96 - 140	MC 10							
		121 - 165	LC 13	137 - 181	MC 14							
		164 - 209	LC 17	176 - 221	MC 18							
304	B-12	27 - 86	KK 32 (Bar Jaw)			49	50	18	30			1.5mm x 60°
	HOH-12K	46 - 114	LD 05	74 - 145	MD 08	59	50	18	30	25	M8	
		102 - 174	LD 11	134 - 207	MD 14							
		165 - 239	LD 17	195 - 296	MD 20							
		228 - 302	LD 23									
381	B-15	50 - 108	LF 05	100 - 162	MF 10	79	60	22	43	33	M8	1.5mm x 60°
	HOH-15K	99 - 162	LF 10	160 - 224	MF 16							
		160 - 224	LF 16	222 - 287	MF 22							
		220 - 285	LF 22	280 - 345	MF 28							
		279 - 345	LF 28									
		339 - 404	LF 34									
450	B-18	50 - 170	LF 05	100 - 225	MF 10	79	60	22	43	33	M8	1.5mm x 60°
		100 - 225	LF 10	160 - 288	MF 16							
		160 - 288	LF 16	222 - 351	MF 22							
		221 - 349	LF 22	279 - 409	MF 28							
		280 - 409	LF 28	338 - 469	MF 34							
		339 - 469	LF 34									
530	B-21	80 - 202	LG 10	100 - 225	MG 10	79	60	25	60	33	M8	3.0mm x 60°
		196 - 324	LG 15	218 - 347	MG 15							
		319 - 449	LG 20	340 - 470	MG 20							
610	B-24	96 - 279	LG 10	118 - 303	MG 10	79	60	25	60	33	M8	3.0mm x 60°
		214 - 403	LG 15	237 - 426	MG 15							
		337 - 527	LG 20	359 - 549	MG 20							

Adjustagrip Jaws are available on request in special sizes or to suit other chuck types.

Adjustagrip Hard Top Jaws

To suit Power Chucks
60° SERRATIONS

Material:

- Steel: 590M17

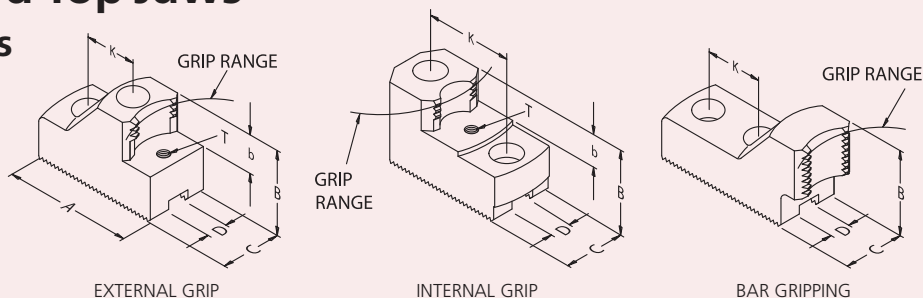

Serrated Hard Top Jaws

To suit • Kitagawa Chuck Series BB

CHUCK Ø	TYPE	EXTERNAL GRIP RANGES	EXTERNAL GRIP JAW PART No	INTERNAL GRIP RANGES	INTERNAL GRIP JAW PART No	B	C	D	K	b	T	SERRATION
170	BB206	16 - 35	KK 16 (Bar Jaw)			39	35	12	20			1.5mm x 60°
		30 - 49	LA 03	51 - 71	MA 05	49	35	12	20	20	M6	
		49 - 69	LA 04	62 - 82	MA 06							
		63 - 83	LA 06	81 - 102	MA 07							
		77 - 98	LA 07	103 - 124	MA 09							
		94 - 114	LA 09									
210	BB208	24 - 49	KK 20 (Bar Jaw)			49	40	14	25			1.5mm x 60°
		46 - 73	LB 03	63 - 92	MB 06	49	40	14	25	20	M6	
		73 - 101	LB 06	92 - 125	MB 08							
		101 - 130	LB 09	125 - 154	MB 11							
		130 - 157	LB 12	154 - 183	MB 14							
254	BB210	33 - 72	KK 25 (Bar Jaw)			49	40	16	30			1.5mm x 60°
		52 - 91	LC 04	70 - 110	MC 06	59	40	16	30	25	M8	
		91 - 133	LC 08	109 - 150	MC 10							
		133 - 177	LC 13	150 - 192	MC 14							
		177 - 219	LC 17	190 - 231	MC 18							
		212 - 254	LC 20									
315	BB212	42 - 103	KK 33 (Bar Jaw)			49	50	21	30			1.5mm x 60°
		65 - 127	LE 05	97 - 160	ME 08	59	50	21	30	25	M8	
		120 - 183	LE 10	160 - 224	ME 14							
		183 - 250	LE 16	219 - 284	ME 20							
		250 - 316	LE 23	281 - 345	ME 26							
450	BB218	80 - 147	LH 05	100 - 167	MH 10	79	60	25.5	43	33	M8	1.5mm x 60°
		140 - 209	LH 10	160 - 229	MH 15							
		202 - 272	LH 15	222 - 292	MH 20							
		263 - 335	LH 20	285 - 356	MH 25							
		328 - 399	LH 25									
530	BB221	80 - 224	LH 05	100 - 243	MH 10	79	60	25.5	43	33	M8	1.5mm x 60°
		140 - 286	LH 10	160 - 306	MH 15							
		202 - 350	LH 15	222 - 370	MH 20							
		263 - 412	LH 20	285 - 433	MH 25							
		328 - 477	LH 25									

Adjustagrip Jaws are available on request in special sizes or to suit other chuck types.

Adjustagrip Hard Top Jaws

To suit Power Chucks
60° SERRATIONS

Material:

- Steel: 590M17

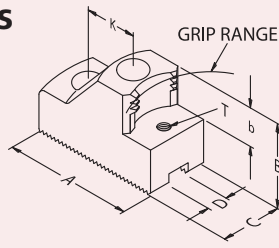

EXTERNAL GRIP

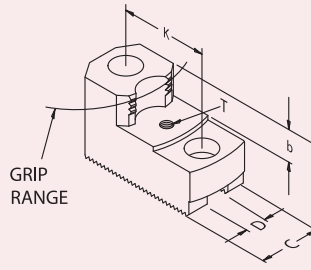

INTERNAL GRIP

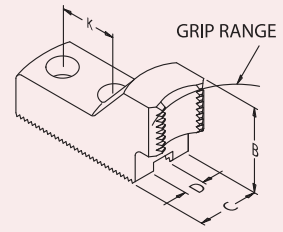

BAR GRIPPING

To suit • Kitagawa Chuck Series BS300

CHUCK Ø	TYPE	EXTERNAL GRIP RANGES	EXTERNAL GRIP JAW PART No	INTERNAL GRIP RANGES	INTERNAL GRIP JAW PART No	B	C	D	K	b	T	SERRATION
169	BS306	14 - 33	KK 16 (Bar Jaw)			39	35	12	20			1.5mm x 60°
		27 - 47	LA 03	47 - 69	MA 05	49	35	12	20	20	M6	
		45 - 67	LA 04	58 - 80	MA 06							
		59 - 81	LA 06	77 - 99	MA 07							
		73 - 96	LA 07	99 - 122	MA 09							
		90 - 112	LA 09									
210	BS308	21 - 47	KK 20 (Bar Jaw)			49	40	14	25			1.5mm x 60°
		43 - 71	LB 03	61 - 90	MB 06	49	40	14	25	20	M6	
		71 - 99	LB 06	90 - 122	MB 08							
		99 - 128	LB 09	122 - 151	MB 11							
		127 - 155	LB 12	151 - 181	MB 14							
254	BS310	29 - 70	KK 25 (Bar Jaw)			49	40	16	30			1.5mm x 60°
		48 - 89	LC 04	65 - 108	MC 06	59	40	16	30	25	M8	
		86 - 130	LC 08	104 - 148	MC 10							
		130 - 174	LC 13	145 - 190	MC 14							
		173 - 217	LC 17	185 - 229	MC 18							
		207 - 252	LC 20									
		247 - 289	LC 24									

Workpiece Height Pins



See page 165

Adjustagrip Jaws are available on request in special sizes or to suit other chuck types.

Adjustagrip Hard Top Jaws

To suit Power Chucks
60° SERRATIONS

Material:

- Steel: 590M17

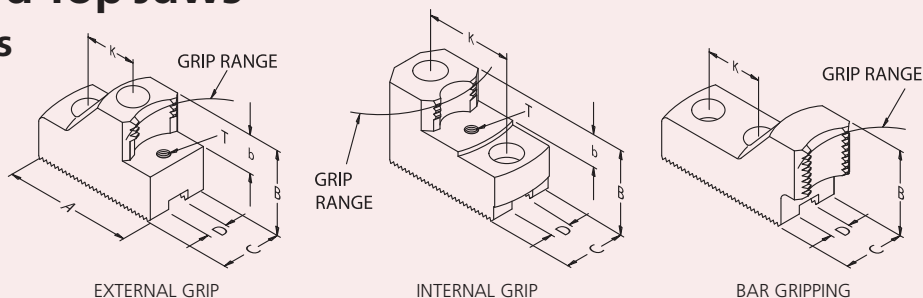

Serrated Hard Top Jaws

To suit • Kitagawa Chuck Series BL200

CHUCK Ø	TYPE	EXTERNAL GRIP RANGES	EXTERNAL GRIP JAW PART No	INTERNAL GRIP RANGES	INTERNAL GRIP JAW PART No	B	C	D	K	b	T	SERRATION
169	BL206	14 - 30	KK 16 (Bar Jaw)			39	35	12	20			1.5mm x 60°
		27 - 45	LA 03	46 - 66	MA 05	49	35	12	20	20	M6	
		42 - 64	LA 04	55 - 77	MA 06							
		56 - 78	LA 06	74 - 97	MA 07							
		70 - 93	LA 07	96 - 119	MA 09							
		86 - 109	LA 09									
215	BL208	24 - 52	KK 20 (Bar Jaw)			49	40	14	25			1.5mm x 60°
		46 - 76	LB 03	63 - 93	MB 06	49	40	14	25	20	M6	
		74 - 103	LB 06	93 - 125	MB 08							
		102 - 132	LB 09	125 - 156	MB 11							
		130 - 160	LB 12	155 - 186	MB 14							
254	BL210	27 - 70	KK 25 (Bar Jaw)			49	40	16	30			1.5mm x 60°
		47 - 89	LC 04	63 - 108	MC 06	59	40	16	30	25	M8	
		84 - 130	LC 08	102 - 148	MC 10							
		128 - 174	LC 13	143 - 190	MC 14							
		171 - 217	LC 17	183 - 229	MC 18							
		205 - 252	LC 20									
304	BL212	32 - 97	KK 33 (Bar Jaw)			49	50	21	30			1.5mm x 60°
		54 - 121	LE 05	85 - 154	ME 08	59	50	21	30	25	M8	
		109 - 177	LE 10	149 - 218	ME 14							
		172 - 242	LE 16	208 - 278	ME 20							
		239 - 310	LE 23	269 - 339	ME 26							

Adjustagrip Jaws are available on request in special sizes or to suit other chuck types.

Adjustagrip Hard Top Jaws

To suit Power Chucks
60° SERRATIONS

Material:

- Steel: 590M17

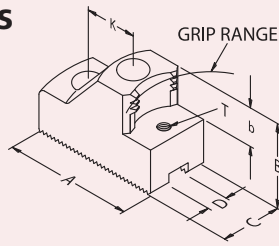

EXTERNAL GRIP

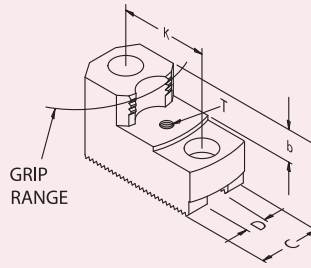

INTERNAL GRIP

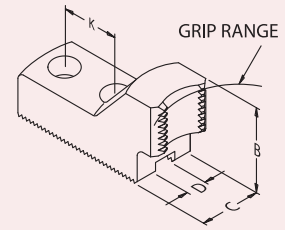

BAR GRIPPING

To suit • Kitagawa Chuck Series NL

CHUCK Ø	TYPE	EXTERNAL GRIP RANGES	EXTERNAL GRIP JAW PART No	INTERNAL GRIP RANGES	INTERNAL GRIP JAW PART No	B	C	D	K	b	T	SERRATION
165	NL06	16 - 32	KK 16 (Bar Jaw)			39	35	12	20			1.5mm x 60°
		30 - 46	LA 03	51 - 67	MA 05	49	35	12	20	20	M6	
		46 - 65	LA 04	62 - 80	MA 06							
		63 - 80	LA 06	80 - 101	MA 07							
		77 - 94	LA 07	101 - 121	MA 09							
		93 - 111	LA 09									
210	NL08	16 - 44	KK 20 (Bar Jaw)			49	40	14	25			1.5mm x 60°
		44 - 67	LB 03	61 - 89	MB 06	49	40	14	25	20	M6	
		72 - 98	LB 06	89 - 120	MB 08							
		97 - 125	LB 09	120 - 152	MB 11							
		125 - 151	LB 12	152 - 177	MB 14							
254	NL10	24 - 63	KK 25 (Bar Jaw)			49	40	16	30			1.5mm x 60°
		48 - 83	LC 04	59 - 102	MC 06	59	40	16	30	25	M8	
		80 - 123	LC 08	98 - 142	MC 10							
		123 - 167	LC 13	139 - 183	MC 14							
		166 - 211	LC 17	178 - 223	MC 18							
304	NL12	29 - 91	KK 32 (Bar Jaw)			49	50	18	30			1.5mm x 60°
		55 - 119	LD 05	84 - 150	MD 08	59	50	18	30	25	M8	
		112 - 179	LD 11	145 - 212	MD 14							
		176 - 244	LD 17	205 - 274	MD 20							
		239 - 307	LD 23									

Workpiece Height Pins

See page 165



Adjustagrip Jaws are available on request in special sizes or to suit other chuck types.

Adjustagrip Hard Top Jaws

To suit Power Chucks
60° SERRATIONS

Material:

- Steel: 590M17

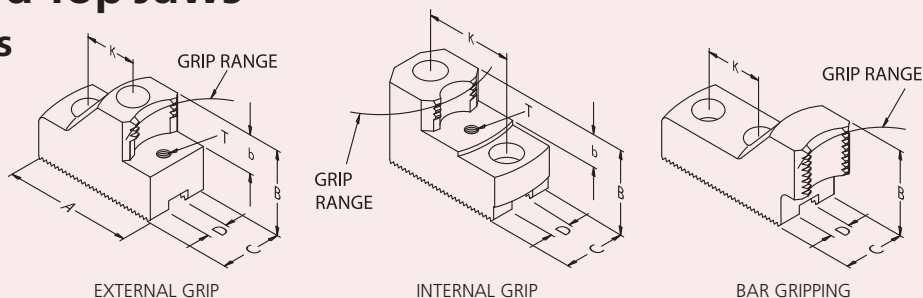

Serrated Hard Top Jaws

To suit • Matsumoto (MMK) Chuck Series ZA

CHUCK Ø	TYPE	EXTERNAL GRIP RANGES	EXTERNAL GRIP JAW PART No	INTERNAL GRIP RANGES	INTERNAL GRIP JAW PART No	B	C	D	K	b	T	SERRATION
210	ZA6-8-52	16 - 45	KK 20 (Bar Jaw)	51 - 85 79 - 115 111 - 148 141 - 178		49	40	14	25	20	M6	1.5mm x 60°
		32 - 68	LB 03			49	40	14	25			
		61 - 96	LB 06									
		88 - 125	LB 09									
		115 - 152	LB 12									
215	ZA6-8-66B	23 - 58	KK 20 (Bar Jaw)	63 - 99 92 - 129 125 - 162 154 - 192		49	40	14	25	20	M6	1.5mm x 60°
		45 - 82	LB 03			49	40	14	25			
		73 - 109	LB 06									
		102 - 139	LB 09									
		129 - 166	LB 12									
254	ZA8-10-66	25 - 63	KK 25 (Bar Jaw)	60 - 101 99 - 141 140 - 182 179 - 222		49	40	16	30	25	M8	1.5mm x 60°
		43 - 82	LC 04			59	40	16	30			
		81 - 123	LC 08									
		123 - 167	LC 13									
		167 - 210	LC 17									
254	ZA8-10-75	25 - 63	KK 25 (Bar Jaw)	60 - 101 99 - 141 140 - 182 179 - 222		49	40	16	30	25	M8	1.5mm x 60°
		43 - 82	LC 04			59	40	16	30			
		81 - 123	LC 08									
		123 - 166	LC 13									
		166 - 210	LC 17									
254	ZA8-10-80B	28 - 63	KK 25 (Bar Jaw)	64 - 103 103 - 144 144 - 183 183 - 223		49	40	16	30	25	M8	1.5mm x 60°
		48 - 85	LC 04			59	40	16	30			
		85 - 128	LC 08									
		128 - 171	LC 13									
		171 - 212	LC 17									
305	ZA8-12-85	33 - 64	KK 32 (Bar Jaw)	89 - 123 150 - 185 211 - 246 269 - 303		59	50	18	30	25	M8	1.5mm x 60°
		60 - 92	LD 05			59	50	18	30			
		118 - 151	LD 11									
		182 - 216	LD 17									
		245 - 279	LD 23									
305	ZA8-12-93B	41 - 73	KK 32 (Bar Jaw)	99 - 133 160 - 194 221 - 256 278 - 313		59	50	18	30	25	M8	1.5mm x 60°
		69 - 102	LD 05			59	50	18	30			
		127 - 161	LD 11									
		192 - 226	LD 17									
		255 - 289	LD 23									

Adjustagrip Jaws are available on request in special sizes or to suit other chuck types.

Adjustagrip Hard Top Jaws

To suit Power Chucks
60° SERRATIONS

Material:

- Steel: 590M17

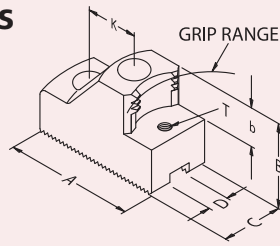

EXTERNAL GRIP

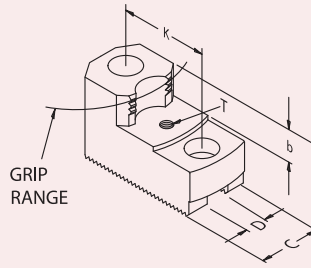

INTERNAL GRIP

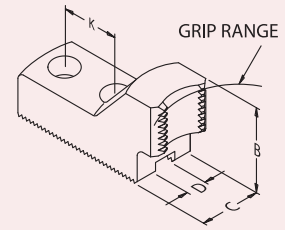

BAR GRIPPING

To suit • Matsumoto (MMK) Chuck Series H/HA

CHUCK Ø	TYPE	EXTERNAL GRIP RANGES	EXTERNAL GRIP JAW PART No	INTERNAL GRIP RANGES	INTERNAL GRIP JAW PART No	B	C	D	K	b	T	SERRATION
210	H-8	19 - 48	KK 20 (Bar Jaw)			49	40	14	25			1.5mm x 60°
	HA6-8	40 - 71	LB 03	58 - 88	MB 06	49	40	14	25	20	M6	
		69 - 99	LB 06	87 - 120	MB 08							
		97 - 128	LB 09	120 - 151	MB 11							
		124 - 155	LB 12	149 - 181	MB 14							
254	H-10	39 - 72	KK 25 (Bar Jaw)			49	40	16	30			1.5mm x 60°
	HA6-10	52 - 92	LC 04	68 - 111	MC 06	59	40	16	30	25	M8	
		89 - 133	LC 08	108 - 151	MC 10							
		133 - 176	LC 13	149 - 192	MC 14							
		176 - 220	LC 17	188 - 232	MC 18							
305	H-12	27 - 87	KK 32 (Bar Jaw)			59	50	18	30			1.5mm x 60°
	HA8-12	50 - 126	LD 05	79 - 157	MD 08	59	50	18	30	25	M8	
		107 - 186	LD 11	139 - 219	MD 14							
		170 - 251	LD 17	200 - 280	MD 20							
		233 - 314	LD 23									

Workpiece Height Pins

See page 165



Adjustagrip Jaws are available on request in special sizes or to suit other chuck types.

Adjustagrip Hard Top Jaws

To suit Power Chucks
60° SERRATIONS

Material:

- Steel: 590M17

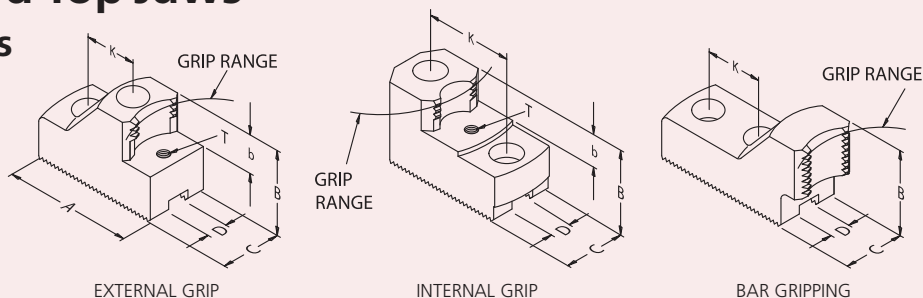

Serrated Hard Top Jaws

To suit • Matsumoto (LMC) Chuck Series PC

CHUCK Ø	TYPE	EXTERNAL GRIP RANGES	EXTERNAL GRIP JAW PART No	INTERNAL GRIP RANGES	INTERNAL GRIP JAW PART No	B	C	D	K	b	T	SERRATION
169	PC-6-46	20 - 36	KK 16 (Bar Jaw)			39	35	12	20			1.5mmx60°
		34 - 52	LA 03	56 - 71	MA 05	49	35	12	20	20	M6	
		52 - 70	LA 04	66 - 83	MA 06							
		68 - 84	LA 06	85 - 104	MA 07							
		82 - 98	LA 07	109 - 125	MA 09							
		98 - 115	LA 09									
210	PC-8-52	16 - 45	KK 20 (Bar Jaw)			49	40	14	25			1.5mm x 60°
		33 - 68	LB 03	51 - 85	MB 06	49	40	14	25	20	M6	
		61 - 96	LB 06	80 - 115	MB 08							
		88 - 125	LB 09	111 - 149	MB 11							
		115 - 152	LB 12	141 - 178	MB 14							
		149 - 186	LB 15									
254	PC-10-78	30 - 70	KK 25 (Bar Jaw)			49	40	16	30			1.5mm x 60°
		50 - 89	LC 04	66 - 108	MC 06	59	40	16	30	25	M8	
		87 - 129	LC 08	105 - 148	MC 10							
		130 - 173	LC 13	146 - 189	MC 14							
		173 - 217	LC 17	185 - 229	MC 18							
		209 - 253	LC 20									
304	PC-12-93	40 - 90	KK 32 (Bar Jaw)			49	50	18	30			1.5mm x 60°
		68 - 118	LD 05	98 - 150	MD 08	59	50	18	30	25	M8	
		126 - 178	LD 11	159 - 212	MD 14							
		190 - 243	LD 17	220 - 273	MD 20							
		253 - 307	LD 23	277 - 330	MD 26							
381	PC-15-120	46 - 109	LF 05	95 - 163	MF 10	79	60	22	43	33	M8	1.5mm x 60°
		95 - 163	LF 10	155 - 226	MF 16							
		155 - 225	LF 16	218 - 289	MF 22							
		216 - 287	LF 22	275 - 346	MF 28							
		275 - 346	LF 28	334 - 406	MF 34							
		334 - 406	LF 34									

Adjustagrip Jaws are available on request in special sizes or to suit other chuck types.

Adjustagrip Hard Top Jaws

To suit Power Chucks
60° SERRATIONS

Material:

- Steel: 590M17

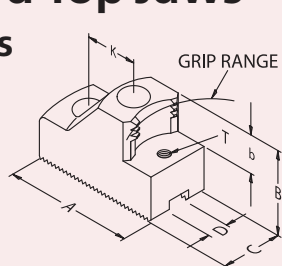

EXTERNAL GRIP

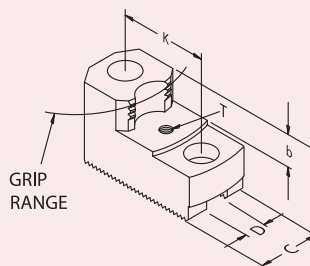

INTERNAL GRIP

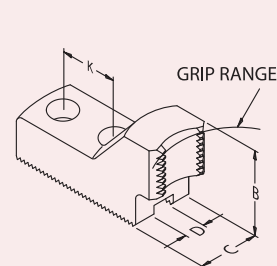

BAR GRIPPING

To suit • Pratt Burnerd Chuck Series International

CHUCK Ø	TYPE	EXTERNAL GRIP RANGES	EXTERNAL GRIP JAW PART No	INTERNAL GRIP RANGES	INTERNAL GRIP JAW PART No	B	C	D	K	b	T	SERRATION
165	International 165	13 - 23	KK 16 (Bar Jaw)			39	35	12	20			1.5mmx60°
		24 - 46	LA 03	45 - 67	MA 05	49	35	12	20	20	M6	
		41 - 65	LA 04	54 - 79	MA 06							
		55 - 80	LA 06	73 - 98	MA 07							
		69 - 94	LA 07	95 - 120	MA 09							
		85 - 111	LA 09									
210	International 210	48 - 74	KK 20 (Bar Jaw)			49	40	14	25			1.5mm x 60°
		39 - 69	LB 03	57 - 86	MB 06	49	40	14	25	20	M6	
		68 - 97	LB 06	86 - 119	MB 08							
		96 - 126	LB 09	119 - 149	MB 11							
		123 - 153	LB 12	148 - 179	MB 14							
254	International 254	38 - 81	KK 25 (Bar Jaw)			49	40	16	30			1.5mm x 60°
		43 - 84	LC 04	59 - 103	MC 06	59	40	16	30	25	M8	
		80 - 124	LC 08	98 - 143	MC 08							
		123 - 168	LC 13	139 - 184	MC 10							
		166 - 212	LC 17	178 - 224	MC 12							
305	International 305	34 - 90	KK 32 (Bar Jaw)			49	50	18	30			1.5mm x 60°
		57 - 124	LD 05	86 - 155	MD 08	59	50	18	30	25	M8	
		114 - 184	LD 11	147 - 217	MD 14							
		178 - 249	LD 17	207 - 278	MD 20							
		241 - 312	LD 23									
380	International 380	59 - 117	LF 05	110 - 171	MF 10	79	60	22	43	33	M8	1.5mm x 60°
		110 - 171	LF 10	171 - 234	MF 16							
		171 - 234	LF 16	234 - 297	MF 22							
		232 - 295	LF 22	291 - 354	MF 28							
		291 - 354	LF 28									
		350 - 414	LF 34									

Adjustagrip Hard Top Jaws

To suit Power Chucks
60° SERRATIONS

Material:

- Steel: 590M17

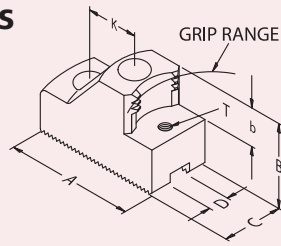

EXTERNAL GRIP

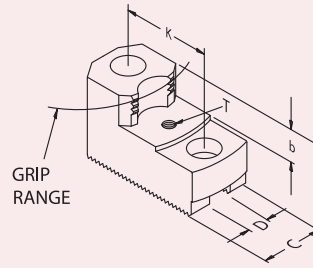

INTERNAL GRIP

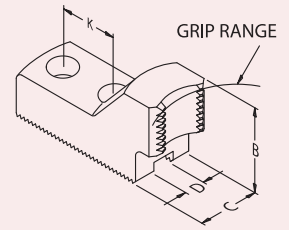

BAR GRIPPING

Serrated Hard Top Jaws

To suit • Pratt Burnerd Chuck Series International Setrite

CHUCK Ø	TYPE	EXTERNAL GRIP RANGES	EXTERNAL GRIP JAW PART No	INTERNAL GRIP RANGES	INTERNAL GRIP JAW PART No	B	C	D	K	b	T	SERRATION
170	9829-17010	16 - 35	KK 16 (Bar Jaw)			39	35	12	20			1.5mm x 60°
	9827- 18100	30 - 50	LA 03	50 - 71	MA 05	49	35	12	20	20	M6	
		49 - 69	LA 04	61 - 82	MA 06							
		63 - 83	LA 06	80 - 102	MA 07							
		77 - 98	LA 07	103 - 124	MA 09							
		94 - 114	LA 09									
210	9821-32223	29 - 44	KK 20 (Bar Jaw)			49	40	14	25			1.5mm x 60°
	9827-22000	51 - 70	LB 03	69 - 87	MB 06	49	40	14	25	20	M6	
		79 - 99	LB 06	98 - 118	MB 08							
		107 - 128	LB 09	131 - 151	MB 11							
		134 - 154	LB 12	160 - 180	MB 14							
265	9821-42723	32 - 74	KK 25 (Bar Jaw)			49	40	16	30			1.5mm x 60°
	9827-27010	52 - 93	LC 04	69 - 112	MC 06	59	40	16	30	25	M8	
		90 - 133	LC 08	108 - 152	MC 08							
		133 - 178	LC 13	149 - 194	MC 10							
		177 - 221	LC 17	189 - 233	MC 12							

Workpiece Height Pins

See page 165



Adjustagrip Hard Top Jaws

To suit Power Chucks
60° SERRATIONS

Material:

- Steel: 590M17

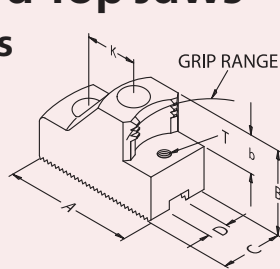

EXTERNAL GRIP

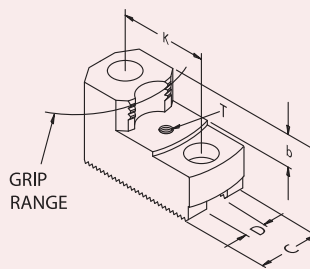

INTERNAL GRIP

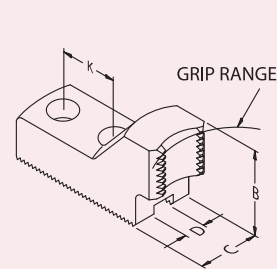

BAR GRIPPING

To suit • Pratt Burnerd Chuck Series Constant Grip/HSQC

CHUCK Ø	TYPE	EXTERNAL GRIP RANGES	EXTERNAL GRIP JAW PART No	INTERNAL GRIP RANGES	INTERNAL GRIP JAW PART No	B	C	D	K	b	T	SERRATION
165	9151-21723	14 - 32	KK 16 (Bar Jaw)			39	35	12	20			1.5mm x 60°
	9151-31723	27 - 46	LA 03			49	35	12	20	20	M6	
	9151-41723	31 - 65	LA 04	47 - 79	MA 06							
	9131-21723	50 - 79	LA 06	67 - 98	MA 07							
	9131-31723	64 - 94	LA 07	82 - 120	MA 09							
	9131-41723	73 - 111	LA 09									
210	9151-32123	16 - 45	KK 20 (Bar Jaw)			49	40	14	25			1.5mm x 60°
	9151-42123	26 - 68	LB 03	51 - 85	MB 06	49	40	14	25	20	M6	
	9151-52123	54 - 96	LB 06	72 - 115	MB 08							
	9131-32123	81 - 125	LB 09	104 - 148	MB 11							
	9131-42123	107 - 152	LB 12	133 - 178	MB 14							
	9131-52123											
254	9151-42623	23 - 64	KK 25 (Bar Jaw)			49	40	16	30			1.5mm x 60°
	9151-52623	39 - 84	LC 04	54 - 102	MC 06	59	40	16	30	25	M8	
	9131-42623	68 - 124	LC 08	85 - 142	MC 08							
	9131-52623	110 - 168	LC 13	126 - 184	MC 10							
		153 - 211	LC 17	165 - 223	MC 12							
305	9151-53123	27 - 95	KK 32 (Bar Jaw)			49	50	18	30			1.5mm x 60°
	9151-63123	44 - 124	LD 05	75 - 154	MD 08	59	50	18	30	25	M8	
	9131-53123	90 - 184	LD 11	122 - 217	MD 14							
	9131-63123	153 - 249	LD 17	182 - 278	MD 20							
		215 - 312	LD 23	239 - 335	MD 26							
380	9151-53823	47 - 109	LF 05	96 - 163	MF 10	79	60	22	43	33	M8	1.5mm x 60°
	9151-63823	82 - 163	LF 10	139 - 226	MF 16							
	9131-53823	139 - 226	LF 16	201 - 289	MF 22							
	9131-63823	199 - 287	LF 22	258 - 346	MF 28							
		258 - 346	LF 28	317 - 406	MF 34							
		317 - 406	LF 34									

Adjustagrip Jaws are available on request in special sizes or to suit other chuck types.

Adjustagrip Hard Top Jaws

To suit Power Chucks
60° SERRATIONS

Material:

- Steel: 590M17

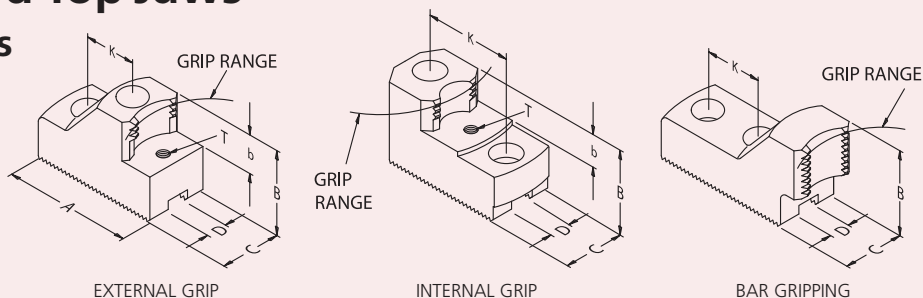

Serrated Hard Top Jaws

To suit • Samchully Chuck Series HS

CHUCK Ø	TYPE	EXTERNAL GRIP RANGES	EXTERNAL GRIP JAW PART No	INTERNAL GRIP RANGES	INTERNAL GRIP JAW PART No	B	C	D	K	b	T	SERRATION
169	HS06	14 - 29	KK 16 (Bar Jaw)			39	35	12	20			1.5mm x 60°
		27 - 44	LA 03	45 - 65	MA 05	49	35	12	20	20	M6	
		40 - 63	LA 04	52 - 76	MA 06							
		54 - 77	LA 06	70 - 96	MA 07							
		68 - 92	LA 07	93 - 118	MA 09							
		84 - 108	LA 09									
210	HS08	18 - 44	KK 20 (Bar Jaw)			49	40	14	25			1.5mm x 60°
		39 - 68	LB 03	56 - 85	MB 06	49	40	14	25	20	M6	
		68 - 96	LB 06	85 - 118	MB 08							
		96 - 124	LB 09	118 - 148	MB 11							
		123 - 151	LB 12	147 - 177	MB 14							
254	HS10	29 - 64	KK 25 (Bar Jaw)			49	40	16	30			1.5mm x 60°
		48 - 85	LC 04	64 - 103	MC 06	59	40	16	30	25	M8	
		85 - 129	LC 08	103 - 144	MC 10							
		129 - 172	LC 13	144 - 184	MC 14							
		172 - 211	LC 17	184 - 224	MC 18							
304	HS12	33 - 87	KK 33 (Bar Jaw)			49	50	21	30			1.5mm x 60°
		55 - 111	LE 05	85 - 149	ME 08	59	50	21	30	25	M8	
		110 - 172	LE 10	149 - 208	ME 14							
		172 - 239	LE 16	207 - 269	ME 20							
		239 - 299	LE 23	269 - 330	ME 26							

Adjustagrip Jaws are available on request in special sizes or to suit other chuck types.

Adjustagrip Hard Top Jaws

To suit Power Chucks
60° SERRATIONS

Material:

- Steel: 590M17

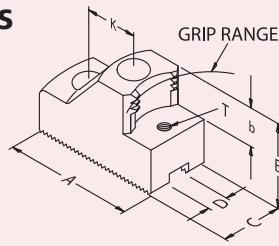

EXTERNAL GRIP

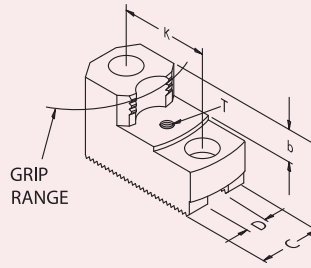

INTERNAL GRIP

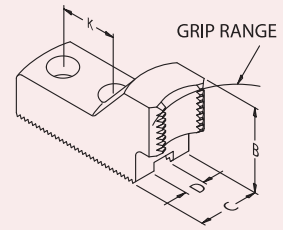

BAR GRIPPING

To suit • Samchully Chuck Series HH & MH

CHUCK Ø	TYPE	EXTERNAL GRIP RANGES	EXTERNAL GRIP JAW PART No	INTERNAL GRIP RANGES	INTERNAL GRIP JAW PART No	B	C	D	K	b	T	SERRATION
175	HH206	19 - 40	KK 16 (Bar Jaw)			39	35	12	20			1.5mm x 60°
	MH206	33 - 55	LA 03	54 - 75	MA 05	49	35	12	20	20	M6	
		52 - 74	LA 04	65 - 86	MA 06							
		66 - 89	LA 06	84 - 106	MA 07							
		81 - 103	LA 07	107 - 128	MA 09							
		97 - 119	LA 09									
210	HH208	25 - 46	KK 20 (Bar Jaw)			49	40	14	25			1.5mm x 60°
	MH208	47 - 74	LB 03	64 - 93	MB 06	49	40	14	25	20	M6	
		74 - 103	LB 06	93 - 123	MB 08							
		103 - 130	LB 09	126 - 155	MB 11							
		130 - 154	LB 12	155 - 179	MB 14							
254	HH210	34 - 67	KK 25 (Bar Jaw)			49	40	16	30			1.5mm x 60°
	MH210	54 - 90	LC 04	71 - 108	MC 06	59	40	16	30	25	M8	
		90 - 127	LC 08	108 - 149	MC 10							
		115 - 149	LC 10	149 - 190	MC 14							
		130 - 171	LC 13	190 - 226	MC 18							
		155 - 191	LC 15									
		179 - 215	LC 17									
315	HH212	43 - 98	KK 33 (Bar Jaw)			49	50	21	30			1.5mm x 60°
	MH212	66 - 122	LE 05	97 - 160	ME 08	59	50	21	30	25	M8	
		121 - 184	LE 10	160 - 219	ME 14							
		184 - 251	LE 16	219 - 281	ME 20							
		251 - 310	LE 23	281 - 340	ME 26							

Workpiece Height Pins

See page 165



Adjustagrip Jaws are available on request in special sizes or to suit other chuck types.

Adjustagrip Hard Top Jaws

To suit Power Chucks
60° SERRATIONS

Material:

- Steel: 590M17

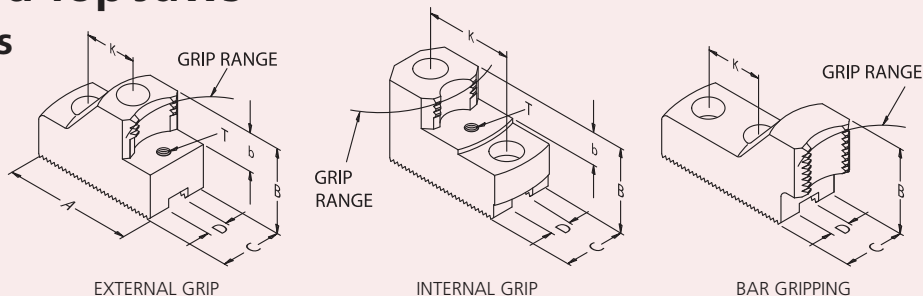

Serrated Hard Top Jaws

To suit • Samchully Chuck Series HCH

CHUCK Ø	TYPE	EXTERNAL GRIP RANGES	EXTERNAL GRIP JAW PART No	INTERNAL GRIP RANGES	INTERNAL GRIP JAW PART No	B	C	D	K	b	T	SERRATION
165	HCH-06	14 - 28	KK 16 (Bar Jaw)			39	35	12	20			1.5mm x 60°
		27 - 42	LA 03	46 - 63	MA 05	49	35	12	20	20	M6	
		35 - 61	LA 04	47 - 74	MA 06							
		50 - 75	LA 06	68 - 94	MA 07							
		64 - 90	LA 07	88 - 116	MA 09							
		78 - 106	LA 09									
210	HCH-08	16 - 41	KK 20 (Bar Jaw)			49	40	14	25			1.5mm x 60°
		31 - 64	LB 03	51 - 81	MB 06	49	40	14	25	20	M6	
		60 - 92	LB 06	78 - 111	MB 08							
		87 - 121	LB 09	110 - 144	MB 11							
114 - 148	LB 12	140 - 174	MB 14									
254	HCH-10	25 - 58	KK 25 (Bar Jaw)			49	40	16	30			1.5mm x 60°
		44 - 81	LC 04	61 - 97	MC 06	59	40	16	30	25	M8	
		81 - 123	LC 08	100 - 136	MC 10							
		123 - 166	LC 13	140 - 178	MC 14							
		166 - 206	LC 17	180 - 217	MC 18							
		203 - 245	LC 20									
245 - 280	LC 24											
304	HCH-12	27 - 86	KK 32 (Bar Jaw)			49	50	18	30			1.5mm x 60°
		49 - 114	LD 05	77 - 145	MD 08	59	50	18	30	25	M8	
		105 - 173	LD 11	138 - 207	MD 14							
		169 - 238	LD 17	198 - 268	MD 20							
231 - 302	LD 23	254 - 326	MD 26									
381	HCH-15	57 - 107	LF 05	108 - 166	MF 10	79	60	22	43	33	M8	1.5mm x 60°
		107 - 170	LF 10	166 - 233	MF 16							
		167 - 233	LF 16	230 - 298	MF 22							
		228 - 295	LF 22	287 - 344	MF 28							
		287 - 354	LF 28	344 - 400	MF 34							
		346 - 400	LF 34									
450	HCH-18	57 - 168	LF 05	108 - 223	MF 10	79	60	22	43	33	M8	1.5mm x 60°
		108 - 223	LF 10	169 - 286	MF 16							
		169 - 286	LF 16	232 - 349	MF 22							
		230 - 347	LF 22	289 - 407	MF 28							
		289 - 407	LF 28	348 - 467	MF 34							
		348 - 467	LF 34									

Adjustagrip Jaws are available on request in special sizes or to suit other chuck types.

Adjustagrip Hard Top Jaws

To suit Power Chucks
60° SERRATIONS

Material:

- Steel: 590M17

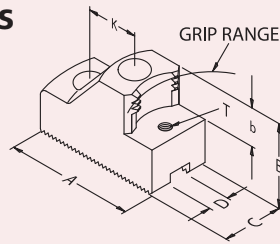

EXTERNAL GRIP

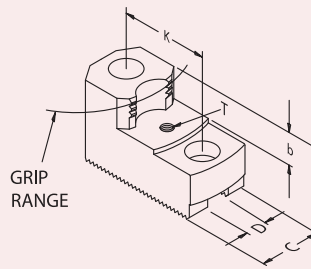

INTERNAL GRIP

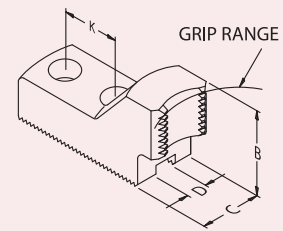

BAR GRIPPING

To suit • Schunk Chuck Series HSL

CHUCK Ø	TYPE	EXTERNAL GRIP RANGES	EXTERNAL GRIP JAW PART No	INTERNAL GRIP RANGES	INTERNAL GRIP JAW PART No	B	C	D	K	b	T	SERRATION
165	HSL 165	20 - 45	KK 16 (Bar Jaw)			39	35	12	20			1.5mm x 60°
		34 - 59	LA 03	55 - 80	MA 05	49	35	12	20	20	M6	
		53 - 78	LA 04	66 - 92	MA 06							
		67 - 93	LA 06	85 - 111	MA 07							
		81 - 108	LA 07	107 - 134	MA 09							
		98 - 124	LA 09									
210	HSL 210	24 - 63	KK 20 (Bar Jaw)			49	40	14	25			1.5mm x 60°
		47 - 87	LB 03	64 - 103	MB 06	49	40	14	25	20	M6	
		75 - 114	LB 06	94 - 133	MB 08							
		103 - 143	LB 09	127 - 167	MB 11							
		130 - 171	LB 12	156 - 197	MB 14							
250	HSL 250	29 - 79	KK 25 (Bar Jaw)			49	40	16	30			1.5mm x 60°
		49 - 98	LC 04	66 - 117	MC 06	59	40	16	30	25	M8	
		87 - 138	LC 08	105 - 157	MC 08							
		131 - 183	LC 13	146 - 198	MC 10							
		174 - 226	LC 17	186 - 238	MC 12							
315	HSL 315	39 - 110	KK 32 (Bar Jaw)			49	50	18	30			1.5mm x 60°
		67 - 138	LD 05	97 - 170	MD 08	59	50	18	30	25	M8	
		125 - 198	LD 11	158 - 232	MD 14							
		189 - 263	LD 17	219 - 293	MD 20							
		252 - 327	LD 23									
400	HSL 400	73 - 173	LF 05	125 - 228	MF 10	79	60	22	43	33	M8	1.5mm x 60°
		125 - 227	LF 10	187 - 291	MF 16							
		187 - 291	LF 16	250 - 354	MF 22							
		248 - 352	LF 22	307 - 412	MF 28							
		307 - 412	LF 28	367 - 472	MF 34							
		367 - 471	LF 34									

Adjustagrip Jaws are available on request in special sizes or to suit other chuck types.

Adjustagrip Hard Top Jaws

To suit Power Chucks
60° SERRATIONS

Material:

- Steel: 590M17

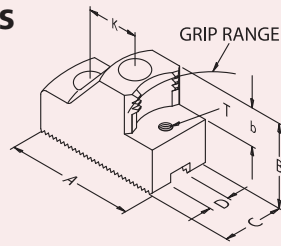

EXTERNAL GRIP

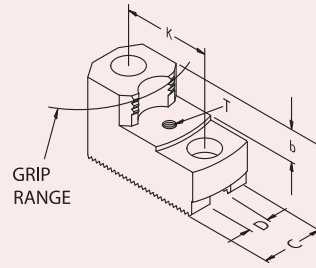

INTERNAL GRIP

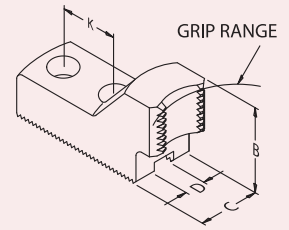

BAR GRIPPING

Serrated Hard Top Jaws

To suit • Schunk Chuck Series Rota NCK

CHUCK Ø	TYPE	EXTERNAL GRIP RANGES	EXTERNAL GRIP JAW PART No	INTERNAL GRIP RANGES	INTERNAL GRIP JAW PART No	B	C	D	K	b	T	SERRATION
169	ROTA	14 - 30	KK 16 (Bar Jaw)	46 - 66	MA 05	39	35	12	20			1.5mm x 60°
	NCK 165	26 - 45	LA 03	53 - 77	MA 06	49	35	12	20	20	M6	
		40 - 64	LA 04	71 - 97	MA 07							
		53 - 78	LA 06	94 - 119	MA 09							
		68 - 93	LA 07									
84 - 109	LA 09											
210	ROTA	18 - 44	KK 20 (Bar Jaw)			49	40	14	25			1.5mm x 60°
	NCK 210	39 - 67	LB 03	57 - 86	MB 06	49	40	14	25	20	M6	
		67 - 96	LB 06	86 - 118	MB 08							
		96 - 124	LB 09	118 - 148	MB 11							
123 - 152	LB 12	148 - 178	MB 14									
254	ROTA	29 - 63	KK 25 (Bar Jaw)			49	40	16	30			1.5mm x 60°
	NCK 250	48 - 55	LC 04	65 - 104	MC 06	59	40	16	30	25	M8	
		85 - 129	LC 08	104 - 144	MC 08							
		129 - 172	LC 13	144 - 184	MC 10							
172 - 212	LC 17	184 - 223	MC 12									
304	ROTA	33 - 86	KK 33 (Bar Jaw)			49	50	21	30			1.5mm x 60°
	NCK 315	55 - 110	LE 05	86 - 149	ME 08	59	50	21	30	25	M8	
		109 - 172	LE 10	149 - 208	ME 14							
		172 - 239	LE 16	208 - 269	ME 20							
239 - 300												

Workpiece Height Pins

See page 165



Adjustagrip Jaws are available on request in special sizes or to suit other chuck types.

Adjustagrip Hard Top Jaws

To suit Power Chucks
60° SERRATIONS

Material:

- Steel: 590M17

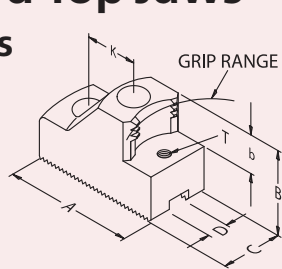

EXTERNAL GRIP

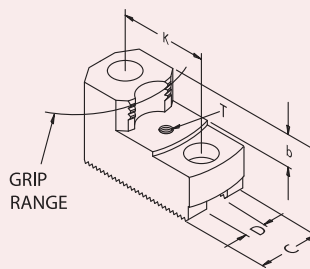

INTERNAL GRIP

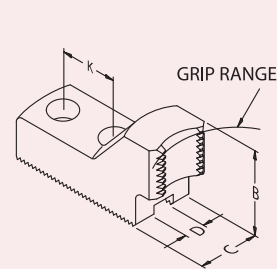

BAR GRIPPING

To suit • Schunk Chuck Series Rota NC/NCF

CHUCK Ø	TYPE	EXTERNAL GRIP RANGES	EXTERNAL GRIP JAW PART No	INTERNAL GRIP RANGES	INTERNAL GRIP JAW PART No	B	C	D	K	b	T	SERRATION	
165	ROTA	14 - 40	KK 16 (Bar Jaw)			39	35	12	20			1.5mm x 60°	
	NC/NCF	27 - 54	LA 03	45 - 74	MA 06	49	35	12	20	20	M6		
	165		44 - 73	LA 04	55 - 86	MA 07							
			57 - 88	LA 06	74 - 105	MA 09							
			71 - 102	LA 07	96 - 128								
	88 - 119	LA 09											
210	ROTA	16 - 57	KK 20 (Bar Jaw)			49	40	14	25			1.5mm x 60°	
	NC/NCF	26 - 81	LB 03	50 - 97	MB 06	49	40	14	25	20	M6		
	210		51 - 109	LB 06	68 - 127	MB 08							
			77 - 138	LB 09	99 - 160	MB 11							
		104 - 165	LB 12	128 - 190	MB 14								
254	ROTA	28 - 80	KK 25 (Bar Jaw)			49	40	16	30			1.5mm x 60°	
	NC/NCF	47 - 99	LC 04	63 - 117	MC 06	59	40	16	30	25	M8		
	250		85 - 139	LC 08	102 - 157	MC 08							
			129 - 184	LC 13	143 - 199	MC 10							
		172 - 227	LC 17	183 - 238	MC 12								
315	ROTA	34 - 118	KK 32 (Bar Jaw)			49	50	18	30			1.5mm x 60°	
	NC/NCF	61 - 146	LD 05	90 - 177	MD 08	59	50	18	30	25	M8		
	315		119 - 206	LD 11	151 - 239	MD 14							
			183 - 271	LD 17	211 - 301	MD 20							
		246 - 334	LD 23	269 - 358	MD 26								
400	ROTA	63 - 152	LF 05	114 - 206	MF 10	79	60	22	43	33	M8	1.5mm x 60°	
	NC/NCF	115 - 206	LF 10	176 - 269	MF 16								
	400		176 - 269	LF 16	238 - 332	MF 22							
			237 - 330	LF 22	295 - 390	MF 28							
			296 - 390	LF 28	355 - 449	MF 34							
		355 - 450	LF 34										

Adjustagrip Jaws are available on request in special sizes or to suit other chuck types.

Adjustagrip Hard Top Jaws

To suit Power Chucks
60° SERRATIONS

Material:

- Steel: 590M17

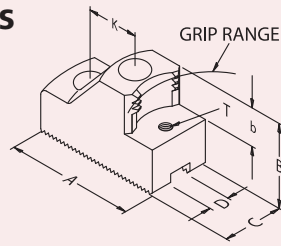

EXTERNAL GRIP

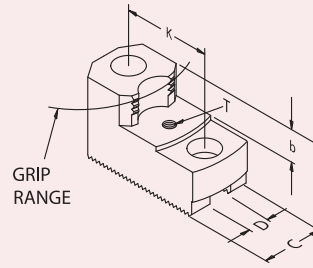

INTERNAL GRIP

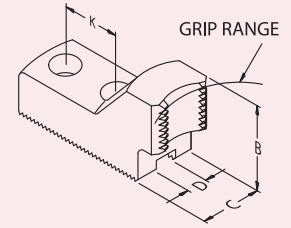

BAR GRIPPING

Serrated Hard Top Jaws

To suit • Schunk Chuck Series Rota-NCK plus

CHUCK Ø	TYPE	EXTERNAL GRIP RANGES	EXTERNAL GRIP JAW PART No	INTERNAL GRIP RANGES	INTERNAL GRIP JAW PART No	B	C	D	K	b	T	SERRATION
169	ROTA NCK	14 - 43	KK 16 (Bar Jaw)			39	35	12	20			1.5mm x 60°
	plus 165	27 - 57	LA 03	46 - 78	MA 05	49	35	12	20	20	M6	
		40 - 76	LA 04	53 - 90	MA 06							
		53 - 91	LA 06	71 - 109	MA 07							
		67 - 105	LA 07	94 - 132	MA 09							
		84 - 122	LA 09									
210	ROTA NCK	16 - 52	KK 20 (Bar Jaw)			49	40	14	25			1.5mm x 60°
	plus 210	32 - 76	LB 03	51 - 93	MB 06	49	40	14	25	20	M6	
		61 - 103	LB 06	79 - 123	MB 08							
		89 - 132	LB 09	112 - 156	MB 11							
		116 - 160	LB 12	141 - 186	MB 14							
254	ROTA NCK	25 - 75	KK 25 (Bar Jaw)			49	40	16	30			1.5mm x 60°
	plus 250	44 - 95	LC 04	60 - 113	MC 06	59	40	16	30	25	M8	
		81 - 135	LC 08	99 - 153	MC 08							
		124 - 179	LC 13	140 - 195	MC 14							
		167 - 223	LC 17	179 - 235	MC 18							
		202 - 257	LC 20									
304	ROTA NCK	31 - 97	KK 32 (Bar Jaw)			49	50	21	30			1.5mm x 60°
	plus 315	52 - 121	LE 05	83 - 154	ME 08	59	50	21	30	25	M8	
		107 - 177	LE 10	147 - 219	ME 14							
		170 - 242	LE 16	205 - 278	ME 20							
		237 - 310	LE 23	267 - 340	ME 26							

Workpiece Height Pins



See page 165

Adjustagrip Jaws are available on request in special sizes or to suit other chuck types.

Adjustagrip Hard Top Jaws

To suit Power Chucks
60° SERRATIONS

Material:

- Steel: 590M17

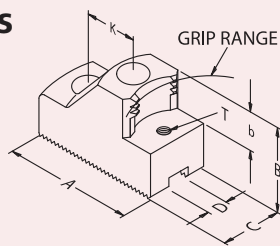

EXTERNAL GRIP

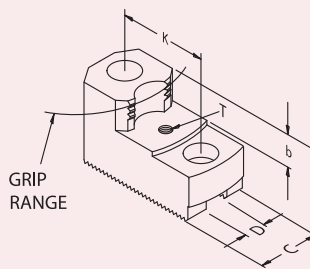

INTERNAL GRIP

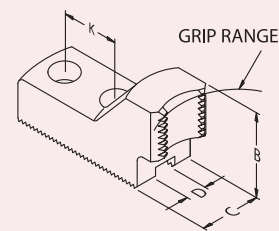

BAR GRIPPING

To suit • Seoam Ace Chuck Series CAH

CHUCK Ø	TYPE	EXTERNAL GRIP RANGES	EXTERNAL GRIP JAW PART No	INTERNAL GRIP RANGES	INTERNAL GRIP JAW PART No	B	C	D	K	b	T	SERRATION
169	CAH-06	14 - 33	KK 16 (Bar Jaw)			39	35	12	20			1.5mm x 60°
		27 - 48	LA 03	48 - 69	MA 05	49	35	12	20	20	M6	
		46 - 67	LA 04	59 - 80	MA 06							
		60 - 81	LA 06	78 - 100	MA 07							
		74 - 96	LA 07	100 - 122	MA 09							
210	CAH-08	16 - 44	KK 20 (Bar Jaw)			49	40	14	25			1.5mm x 60°
		36 - 68	LB 03	54 - 85	MB 06	49	40	14	25	20	M6	
		65 - 95	LB 06	83 - 115	MB 08							
		92 - 124	LB 09	115 - 148	MB 11							
		119 - 152	LB 12	145 - 177	MB 14							
254	CAH-10	31 - 65	KK 25 (Bar Jaw)			49	40	16	30			1.5mm x 60°
		51 - 84	LC 04	68 - 103	MC 06	59	40	16	30	25	M8	
		89 - 124	LC 08	107 - 143	MC 10							
		132 - 169	LC 13	148 - 184	MC 14							
		176 - 212	LC 17	187 - 224	MC 18							
304	CAH-12	37 - 91	KK 32 (Bar Jaw)			49	50	18	30			1.5mm x 60°
		59 - 115	LE 05	91 - 148	ME 08	59	50	18	30	25	M8	
		114 - 171	LE 10	154 - 212	ME 14							
		178 - 236	LE 16	213 - 272	ME 20							
		245 - 303	LE 23	275 - 333	ME 26							
381	CAH-15	57 - 107	LF 05	109 - 167	MF 10	79	60	22	43	33	M8	1.5mm x 60°
		107 - 167	LF 10	167 - 230	MF 16							
		167 - 228	LF 16	230 - 287	MF 22							
		228 - 287	LF 22	287 - 347	MF 28							
		287 - 347	LF 28	347 - 398	MF 34							
450	CAH-18	57 - 159	LF 05	109 - 214	MF 10	79	60	22	43	33	M8	1.5mm x 60°
		108 - 214	LF 10	169 - 277	MF 16							
		169 - 277	LF 16	232 - 340	MF 22							
		230 - 338	LF 22	289 - 398	MF 28							
		289 - 398	LF 28	348 - 458	MF 34							
348 - 458	LF 34											

Adjustagrip Jaws are available on request in special sizes or to suit other chuck types.

Adjustagrip Hard Top Jaws

To suit Power Chucks
60° SERRATIONS

Material:

- Steel: 590M17

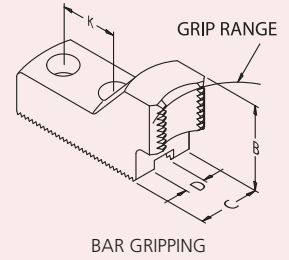
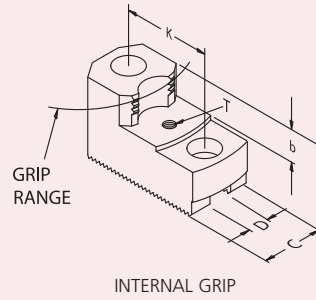
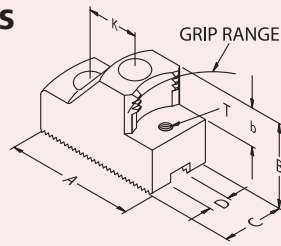

Serrated Hard Top Jaws

To suit • Seoam Ace Chuck Series CGH

CHUCK Ø	TYPE	EXTERNAL GRIP RANGES	EXTERNAL GRIP JAW PART No	INTERNAL GRIP RANGES	INTERNAL GRIP JAW PART No	B	C	D	K	b	T	SERRATION
169	CGH-06	18 - 34	KK 16 (Bar Jaw)			39	35	12	20			1.5mm x 60°
		32 - 50	LA 03	53 - 70	MA 05	49	35	12	20	20	M6	
		50 - 68	LA 04	64 - 83	MA 06							
		65 - 82	LA 06	83 - 104	MA 07							
		79 - 97	LA 07	104 - 123	MA 09							
		96 - 113	LA 09									
210	CGH-08	28 - 46	KK 20 (Bar Jaw)			49	40	14	25			1.5mm x 60°
		51 - 72	LB 03	68 - 88	MB 06	49	40	14	25	20	M6	
		78 - 100	LB 06	97 - 120	MB 08							
		106 - 130	LB 09	129 - 153	MB 11							
		133 - 154	LB 12	158 - 180	MB 14							
254	CGH-10	32 - 66	KK 25 (Bar Jaw)			49	40	16	30			1.5mm x 60°
		52 - 89	LC 04	69 - 107	MC 06	59	50	21	30	25	M8	
		89 - 132	LC 08	107 - 148	MC 10							
		132 - 175	LC 13	148 - 188	MC 14							
		175 - 214	LC 17	188 - 226	MC 18							

Workpiece Height Pins

See page 165



Adjustagrip Jaws are available on request in special sizes or to suit other chuck types.

Adjustagrip Hard Top Jaws

To suit Power Chucks
60° SERRATIONS

Material:

- Steel: 590M17

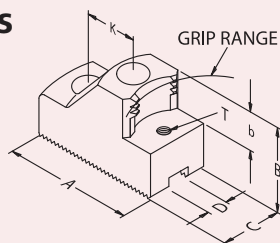

EXTERNAL GRIP

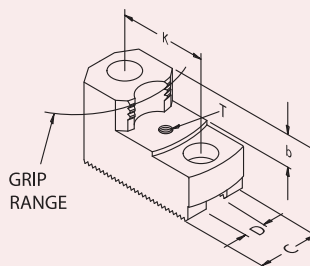

INTERNAL GRIP

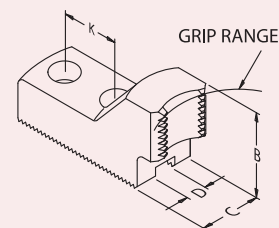

BAR GRIPPING

To suit • SMW-Autoblok Chuck Series BB-M

CHUCK Ø	TYPE	EXTERNAL GRIP RANGES	EXTERNAL GRIP JAW PART No	INTERNAL GRIP RANGES	INTERNAL GRIP JAW PART No	B	C	D	K	b	T	SERRATION
175	BB-M175	18 - 50	KK 16 (Bar Jaw)			39	35	12	20			1.5mm x 60°
		33 - 64	LA 03	54 - 85	MA 05	49	40	12	20	20	M6	
		52 - 83	LA 04	65 - 97	MA 06							
		66 - 98	LA 06	84 - 116	MA 07							
		80 - 112	LA 07	104 - 139	MA 09							
210	BB-M210	23 - 52	KK 20 (Bar Jaw)			49	40	14	25			1.5mm x 60°
		46 - 76	LB 03	63 - 93	MB 06	49	40	14	25	20	M6	
		74 - 103	LB 06	93 - 123	MB 08							
		102 - 132	LB 09	126 - 155	MB 11							
		130 - 160	LB 12	155 - 186	MB 14							
254	BB-M250	38 - 63	KK 25 (Bar Jaw)			49	40	16	30			1.5mm x 60°
		58 - 83	LC 04	75 - 101	MC 06	59	40	16	30	25	M8	
		78 - 103	LC 06	95 - 121	MC 08							
		97 - 123	LC 08	115 - 141	MC 10							
		117 - 143	LC 10	135 - 161	MC 12							
		140 - 167	LC 13	155 - 183	MC 14							
		160 - 187	LC 15	175 - 201	MC 16							
184 - 210	LC 17	196 - 222	MC 18									
315	BB-M315	65 - 101	KK 33 (Bar Jaw)			49	50	21	30			1.5mm x 60°
		89 - 125	LE 05	122 - 158	ME 08	59	50	21	30	25	M8	
		117 - 153	LE 07	154 - 190	ME 10							
		145 - 181	LE 10	186 - 222	ME 14							
		175 - 211	LE 13	215 - 251	ME 18							
		210 - 246	LE16	245 - 282	ME 20							
		243 - 279	LE 20	275 - 312	ME 24							
277 - 314	LE 23											

Adjustagrip Jaws are available on request in special sizes or to suit other chuck types.

Adjustagrip Hard Top Jaws

To suit Power Chucks
60° SERRATIONS

Material:

- Steel: 590M17

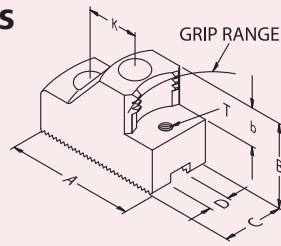

EXTERNAL GRIP

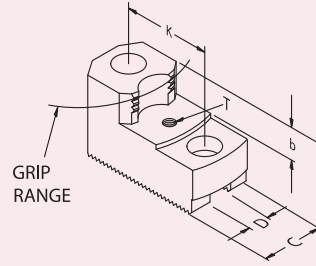

INTERNAL GRIP

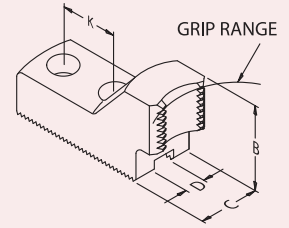

BAR GRIPPING

Serrated Hard Top Jaws

To suit • SMW-Autoblok Chuck Series BH-M

CHUCK Ø	TYPE	EXTERNAL GRIP RANGES	EXTERNAL GRIP JAW PART No	INTERNAL GRIP RANGES	INTERNAL GRIP JAW PART No	B	C	D	K	b	T	SERRATION
165	BH-M165	13 - 38	KK 16 (Bar Jaw)	46 - 73 54 - 85 72 - 104 95 - 127	MA 05 MA 06 MA 07 MA 09	39	35	12	20	20	M6	1.5mm x 60°
		27 - 52	LA 03			49	40	12	20			
		41 - 71	LA 04									
		55 - 86	LA 06									
		69 - 101	LA 07									
		85 - 117	LA 09									
210	BH-M210	16 - 51	KK 20 (Bar Jaw)	51 - 92 79 - 122 111 - 155 140 - 185	MB 06 MB 08 MB 11 MB 14	49	40	14	25	20	M6	1.5mm x 60°
		32 - 75	LB 03			49	40	14	25			
		60 - 102	LB 06									
		88 - 132	LB 09									
		115 - 159	LB 12									
254	BH-M250	29 - 62	KK 25 (Bar Jaw)	65 - 100 85 - 120 104 - 140 124 - 160 145 - 182 165 - 200 185 - 221	MC 06 MC 08 MC 10 MC 12 MC 14 MC 16 MC 18	49	40	16	30	25	M8	1.5mm x 60°
		48 - 82	LC 04			59	40	16	30			
		68 - 102	LC 06									
		86 - 122	LC 08									
		106 - 142	LC 10									
		130 - 166	LC 13									
		150 - 186	LC 15									
		173 - 209	LC 17									
315	BH-M315	37 - 102	KK 33 (Bar Jaw)	92 - 159 156 - 223 215 - 283	ME 08 ME 14 ME 20	49	50	21	30	25	M8	1.5mm x 60°
		60 - 126	LE 05			59	50	21	30			
		115 - 182	LE 10									
		179 - 246	LE 16									
		246 - 315	LE 23									

Adjustagrip Jaws are available on request in special sizes or to suit other chuck types.

Adjustagrip Hard Top Jaws

To suit Power Chucks
60° SERRATIONS

Material:

- Steel: 590M17

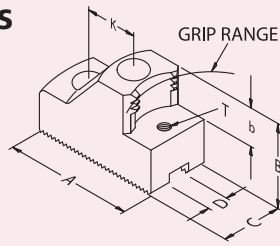

EXTERNAL GRIP

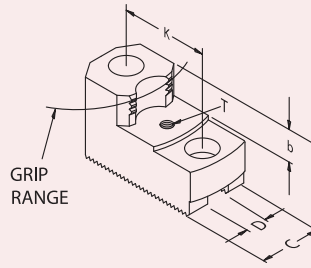

INTERNAL GRIP

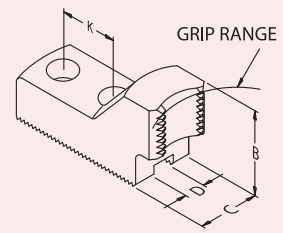

BAR GRIPPING

To suit • SMW-Autoblok Chuck Series AL-M

CHUCK Ø	TYPE	EXTERNAL GRIP RANGES	EXTERNAL GRIP JAW PART No	INTERNAL GRIP RANGES	INTERNAL GRIP JAW PART No	B	C	D	K	b	T	SERRATION
165	AL-M165	13 - 40	KK 16 (Bar Jaw)			39	35	12	20			1.5mm x 60°
		27 - 54	LA 03	47 - 75	MA 05	49	40	12	20	20	M6	
		45 - 79	LA 04	58 - 87	MA 06							
		58 - 88	LA 06	76 - 107	MA 07							
		73 - 103	LA 07	99 - 129	MA 09							
		89 - 119	LA 09									
210	AL-M210	23 - 54	KK 20 (Bar Jaw)			49	40	14	25			1.5mm x 60°
		45 - 77	LB 03	63 - 94	MB 06	49	40	14	25	20	M6	
		74 - 105	LB 06	92 - 125	MB 08							
		102 - 134	LB 09	125 - 158	MB 11							
		129 - 162	LB 12	155 - 187	MB 14							
254	AL-M250	34 - 68	KK 25 (Bar Jaw)			49	40	16	30			1.5mm x 60°
		53 - 87	LC 04	71 - 106	MC 06	59	40	16	30	25	M8	
		73 - 107	LC 06	91 - 126	MC 08							
		92 - 128	LC 08	110 - 146	MC 10							
		112 - 148	LC 10	130 - 161	MC 12							
		135 - 172	LC 13	151 - 188	MC 14							
		155 - 192	LC 15	171 - 195	MC 16							
		179 - 215	LC 17	191 - 227	MC 18							
315	AL-M315	32 - 107	KK 33 (Bar Jaw)			49	50	21	30			1.5mm x 60°
		54 - 131	LE 05	85 - 164	ME 08	59	50	21	30	25	M8	
		109 - 187	LE 10	149 - 228	ME 14							
		172 - 252	LE 16	208 - 288	ME 20							
		239 - 320	LE 23									

Workpiece Height Pins

See page 165



Adjustagrip Jaws are available on request in special sizes or to suit other chuck types.

Adjustagrip Hard Top Jaws

To suit Power Chucks
60° SERRATIONS

Material:

- Steel: 590M17

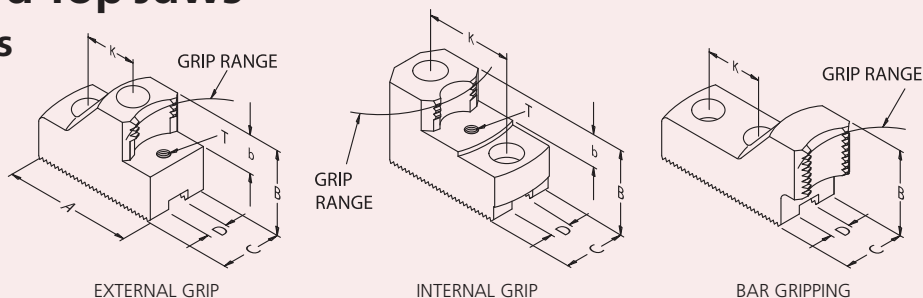

Serrated Hard Top Jaws

To suit • SMW-Autoblok Chuck Series AN-M

CHUCK Ø	TYPE	EXTERNAL GRIP RANGES	EXTERNAL GRIP JAW PART No	INTERNAL GRIP RANGES	INTERNAL GRIP JAW PART No	B	C	D	K	b	T	SERRATION
165	AN-M165	13 - 37	KK 16 (Bar Jaw)			39	35	12	20			1.5mm x 60°
		27 - 52	LA 03	46 - 73	MA 05	49	40	12	20	20	M6	
		43 - 71	LA 04	55 - 85	MA 06							
		56 - 86	LA 06	74 - 104	MA 07							
		70 - 100	LA 07	96 - 126	MA 09							
		87 - 117	LA 09									
210	AN-M210	20 - 50	KK 20 (Bar Jaw)			49	40	14	25			1.5mm x 60°
		42 - 74	LB 03	59 - 90	MB 06	49	40	14	25	20	M6	
		70 - 101	LB 06	89 - 121	MB 08							
		98 - 130	LB 09	121 - 154	MB 11							
		125 - 158	LB 12	151 - 183	MB 14							
254	AN-M250	30 - 63	KK 25 (Bar Jaw)			49	40	16	30			1.5mm x 60°
		49 - 83	LC 04	66 - 101	MC 06	59	40	16	30	25	M8	
		69 - 103	LC 06	86 - 121	MC 08							
		87 - 123	LC 08	105 - 141	MC 10							
		107 - 143	LC 10	125 - 162	MC 12							
		131 - 167	LC 13	146 - 183	MC 14							
		151 - 187	LC 15	166 - 201	MC 16							
		174 - 210	LC 17	186 - 222	MC 18							
315	AN-M315	28 - 101	KK 33 (Bar Jaw)			49	50	21	30			1.5mm x 60°
		49 - 124	LE 05	79 - 158	ME 08	59	50	21	30	25	M8	
		103 - 181	LE 10	143 - 222	ME 14							
		166 - 246	LE 16	201 - 282	ME 20							
		233 - 313	LE 23									

Adjustagrip Jaws are available on request in special sizes or to suit other chuck types.

Adjustagrip Hard Top Jaws

To suit Power Chucks
60° SERRATIONS

Material:

- Steel: 590M17

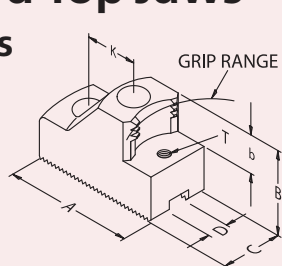

EXTERNAL GRIP

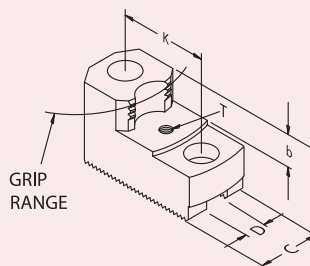

INTERNAL GRIP

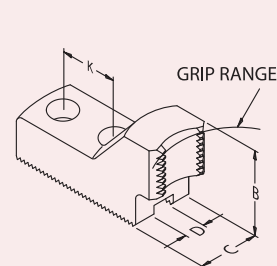

BAR GRIPPING

To suit • Tonfou Chuck Series TF3B

CHUCK Ø	TYPE	EXTERNAL GRIP RANGES	EXTERNAL GRIP JAW PART No	INTERNAL GRIP RANGES	INTERNAL GRIP JAW PART No	B	C	D	K	b	T	SERRATION
169	TF3B-06	14 - 32	KK 16 (Bar Jaw)			39	35	12	20			1.5mm x 60°
		27 - 47	LA 03	46 - 68	MA 05	49	35	12	20	20	M6	
		37 - 66	LA 04	49 - 80	MA 06							
		50 - 81	LA 06	68 - 99	MA 07							
		64 - 95	LA 07	90 - 121	MA 09							
		81 - 112	LA 09									
210	TF3B-08	16 - 44	KK 20 (Bar Jaw)			49	40	14	25			1.5mm x 60°
		32 - 68	LB 03	51 - 85	MB 06	49	40	14	25	20	M6	
		60 - 95	LB 06	78 - 115	MB 08							
		88 - 124	LB 09	111 - 148	MB 11							
		115 - 152	LB 12	140 - 177	MB 14							
254	TF3B-10	26 - 65	KK 25 (Bar Jaw)			49	40	16	30			1.5mm x 60°
		45 - 84	LC 04	61 - 103	MC 06	59	40	16	30	25	M8	
		82 - 125	LC 08	100 - 143	MC 10							
		125 - 168	LC 13	141 - 184	MC 14							
		168 - 212	LC 17	180 - 224	MC 18							
304	TF3B-12	28 - 88	KK 33 (Bar Jaw)			49	50	21	30			1.5mm x 60°
		49 - 111	LE 05	79 - 145	ME 08	59	50	21	30	25	M8	
		102 - 168	LE 10	142 - 209	ME 14							
		166 - 233	LE 16	201 - 268	ME 20							
		233 - 300	LE 23	262 - 330	ME 26							
381	TF3B-15	50 - 107	LF 05	100 - 161	MF 10	79	60	22	43	33	M8	1.5mm x 60°
		100 - 161	LF 10	160 - 224	MF 16							
		160 - 224	LF 16	223 - 287	MF 22							
		221 - 285	LF 22	280 - 344	MF 28							
		280 - 344	LF 28	339 - 404	MF 34							
		339 - 404	LF 34									

Adjustagrip Jaws are available on request in special sizes or to suit other chuck types.

Adjustagrip Hard Top Jaws

To suit Power Chucks
60° SERRATIONS

Material:

- Steel: 590M17

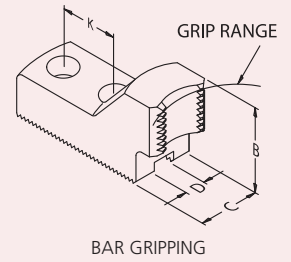
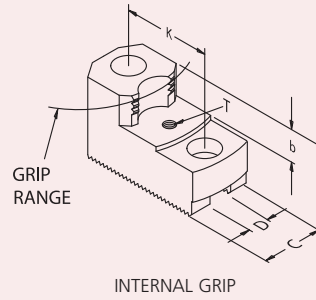
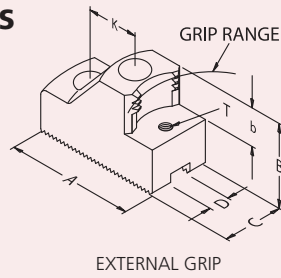

Serrated Hard Top Jaws

To suit • Tonfou Chuck Series TF3XA

CHUCK Ø	TYPE	EXTERNAL GRIP RANGES	EXTERNAL GRIP JAW PART No	INTERNAL GRIP RANGES	INTERNAL GRIP JAW PART No	B	C	D	K	b	T	SERRATION
175	TF3X-6	14 - 32	KK 16 (Bar Jaw)			39	35	12	20			1.5mm x 60°
		27 - 47	LA 03	46 - 68	MA 05	49	35	12	20	20	M6	
		37 - 66	LA 04	49 - 80	MA 06							
		50 - 81	LA 06	68 - 99	MA 07							
		64 - 95	LA 07	90 - 121	MA 09							
		81 - 112	LA 09									
215	TF3X-8	23 - 49	KK 20 (Bar Jaw)			49	40	14	25			1.5mm x 60°
		45 - 73	LB 03	62 - 91	MB 06	49	40	14	25	20	M6	
		73 - 101	LB 06	91 - 124	MB 08							
		101 - 130	LB 09	124 - 154	MB 11							
		129 - 157	LB 12	154 - 183	MB 14							
254	TF3X-10	26 - 65	KK 25 (Bar Jaw)			49	40	16	30			1.5mm x 60°
		45 - 84	LC 04	61 - 103	MC 06	59	40	16	30	25	M8	
		82 - 124	LC 08	100 - 143	MC 10							
		125 - 168	LC 13	141 - 184	MC 14							
		168 - 212	LC 17	180 - 224	MC 18							

Workpiece Height Pins



Adjustagrip Jaws are available on request in special sizes or to suit other chuck types.

Adjustagrip Hard Top Jaws

To suit Power Chucks
60° SERRATIONS

Material:

- Steel: 590M17

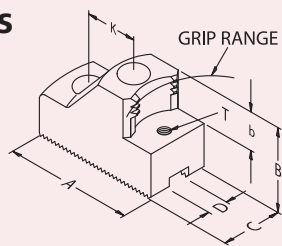

EXTERNAL GRIP

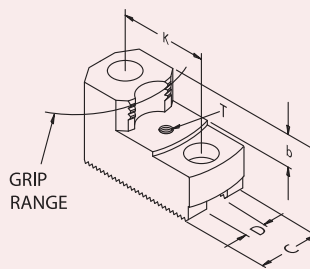

INTERNAL GRIP

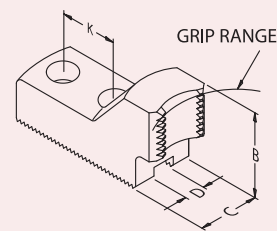

BAR GRIPPING

To suit • Tonfou Chuck Series V

CHUCK Ø	TYPE	EXTERNAL GRIP RANGES	EXTERNAL GRIP JAW PART No	INTERNAL GRIP RANGES	INTERNAL GRIP JAW PART No	B	C	D	K	b	T	SERRATION
165	V-206	14 - 31	KK 16 (Bar Jaw)			39	35	12	20			1.5mmx60°
		27 - 45	LA 03	48 - 66	MA 05	49	35	12	20	20	M6	
		45 - 64	LA 04	59 - 78	MA 06							
		60 - 79	LA 06	78 - 97	MA 07							
		74 - 93	LA 07	100 - 119	MA 09							
		90 - 110	LA 09									
210	V-208	21 - 44	KK 20 (Bar Jaw)			49	40	14	25			1.5mmx60°
		42 - 70	LB 03	60 - 88	MB 06	49	40	14	25	20	M6	
		70 - 98	LB 06	88 - 121	MB 08							
		98 - 125	LB 09	121 - 150	MB 11							
		125 - 151	LB 12	150 - 177	MB 14							
254	V-210	24 - 71	KK 25 (Bar Jaw)			49	40	16	30			1.5mmx60°
		42 - 90	LC 04	59 - 109	MC 06	59	40	16	30	25	M8	
		79 - 130	LC 08	97 - 149	MC 10							
		123 - 175	LC 13	138 - 190	MC 14							
		166 - 218	LC 17	178 - 230	MC 18							
304	V-212	27 - 88	KK 32 (Bar Jaw)			49	50	18	30			1.5mmx60°
		51 - 116	LD 05	79 - 147	MD 08	59	50	18	30	25	M8	
		108 - 176	LD 11	140 - 209	MD 14							
		171 - 241	LD 17	201 - 271	MD 20							
		234 - 304	LD 23	258 - 328	MD 26							

Adjustagrip Jaws are available on request in special sizes or to suit other chuck types.

Adjustagrip Hard Top Jaws

To suit Power Chucks
90° SERRATIONS

Material:

- Steel: 590M17

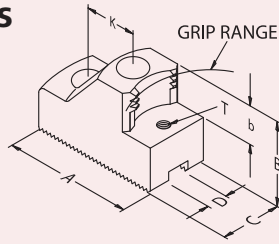

EXTERNAL GRIP

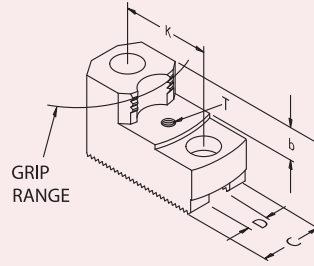

INTERNAL GRIP

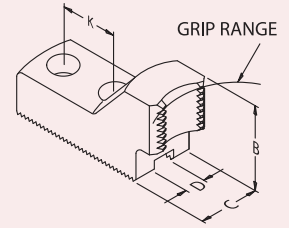

BAR GRIPPING

Serrated Hard Top Jaws

To suit • Berg Chuck Series KH

CHUCK Ø	TYPE	EXTERNAL GRIP RANGES	EXTERNAL GRIP JAW PART No	INTERNAL GRIP RANGES	INTERNAL GRIP JAW PART No	B	C	D	K	b	T	SERRATION
140	KH140	36 - 58	IF 01	ON REQUEST	ON REQUEST	37	30	10	17.5	13	M6	1/16" x 90°
		59 - 83	IF 02									
		83 - 105	IF 03									
		103 - 126	IF 04									
160	KH160	45 - 77	IF 01	ON REQUEST	ON REQUEST	37	30	10	17.5	13	M6	1/16" x 90°
		70 - 102	IF 02									
		93 - 126	IF 03									
		113 - 146	IF 04									
175	KH175	41 - 60	IG 01	ON REQUEST	ON REQUEST	50	35	12	21	20	M6	1/16" x 90°
		58 - 79	IG 02									
		78 - 98	IG 03									
		97 - 118	IG 04									
		117 - 138	IG 05									
		136 - 158	IG 06									
		156 - 177	IG 07									
200	KH200	52 - 83	IG 01	ON REQUEST	ON REQUEST	50	35	12	21	20	M6	1/16" x 90°
		72 - 102	IG 02									
		91 - 122	IG 03									
		110 - 141	IG 04									
		130 - 161	IG 05									
		150 - 181	IG 06									
		170 - 201	IG 07									
250	KH250	53 - 83	IH 01	ON REQUEST	ON REQUEST	60	45	16	29	22	M6	1/16" x 90°
		83 - 110	IH 02									
		109 - 137	IH 03									
		136 - 164	IH 04									
		163 - 192	IH 05									
315	KH315	79 - 144	IH 01	ON REQUEST	ON REQUEST	60	45	16	29	22	M6	1/16" x 90°
		108 - 173	IH 02									
		135 - 201	IH 03									
		162 - 229	IH 04									
		190 - 256	IH 05									

Adjustagrip Jaws are available on request in special sizes or to suit other chuck types.

Adjustagrip Hard Top Jaws

To suit Power Chucks
90° SERRATIONS

Material:

- Steel: 590M17

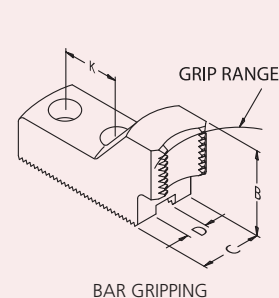
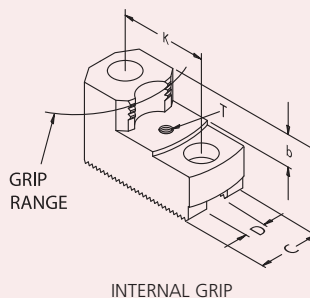
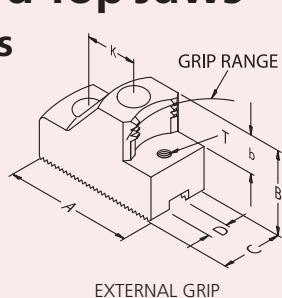

To suit • Forkardt Chuck Series KS

CHUCK Ø	TYPE	EXTERNAL GRIP RANGES	EXTERNAL GRIP JAW PART No	INTERNAL GRIP RANGES	INTERNAL GRIP JAW PART No	B	C	D	K	b	T	SERRATION
160	KS 160	14 - 26	KJ 16 (Bar Jaw)			39	40	17	19			1/16" x 90°
		34 - 45	IA 03	55 - 65	JA 05	49	40	17	19	20	M6	
		40 - 64	IA 05	62 - 87	JA 07							
		57 - 85	IA 07	82 - 108	JA 09							
		78 - 107	IA 09	97 - 130	JA 11							
		97 - 130	IA 11									
200	KS 200	19 - 40	KJ 20 (Bar Jaw)			49	40	17	22			1/16" x 90°
		34 - 56	IB 04	60 - 91	JB 06	49	40	17	22	20	M6	
		56 - 84	IB 05	91 - 122	JB 09							
		83 - 112	IB 08	122 - 151	JB 12							
		112 - 142	IB 11									
		141 - 171	IB 14									
250	KS 250	19 - 40	KJ 20 (Bar Jaw)			49	40	17	22			1/16" x 90°
		34 - 105	IB 04	60 - 137	JB 06	49	40	17	22	20	M6	
		56 - 132	IB 05	91 - 169	JB 09							
		83 - 161	IB 08	122 - 201	JB 12							
		112 - 191	IB 11									
		141 - 221	IB 14									
315	KS 315	29 - 110	KJ 32 (Bar Jaw)			49	50	21	25			1/16" x 90°
		40 - 147	IC 05	81 - 166	JC 08	59	50	21	25	25	M8	
		80 - 192	IC 08	105 - 220	JC 10							
		128 - 244	IC 13	155 - 271	JC 15							
		179 - 295	IC 18									
400	KS 400	29 - 110	KJ 32 (Bar Jaw)			49	50	21	25			1/16" x 90°
		50 - 195	IC 04	81 - 250	JC 08	59	50	21	25	25	M8	
		80 - 275	IC 08	105 - 303	JC 10							
		128 - 327	IC 13	155 - 355	JC 15							
		179 - 379	IC 18									
500	KS 500	40 - 150	KJ 40 (Bar Jaw)			59	60	25.5	35			3/32" x 90°
		54 - 237	ID 06	96 - 283	JD 10	79	60	25.5	35	33	M8	
		95 - 325	ID 13	129 - 363	JD 17							
		178 - 412	ID 21	207 - 442	JD 25							
		226 - 502	ID 30									
630	KS 630	40 - 150	KJ 40 (Bar Jaw)			59	60	25.5	35			3/32" x 90°
		73 - 363	ID 06	118 - 410	JD 10	79	60	25.5	35	33	M8	
		158 - 452	ID 13	194 - 489	JD 17							
		294 - 539	ID 21	273 - 569	JD 25							
		332 - 629	ID 30									

Adjustagrip Hard Top Jaws

To suit Power Chucks
90° SERRATIONS

Material:

- Steel: 590M17

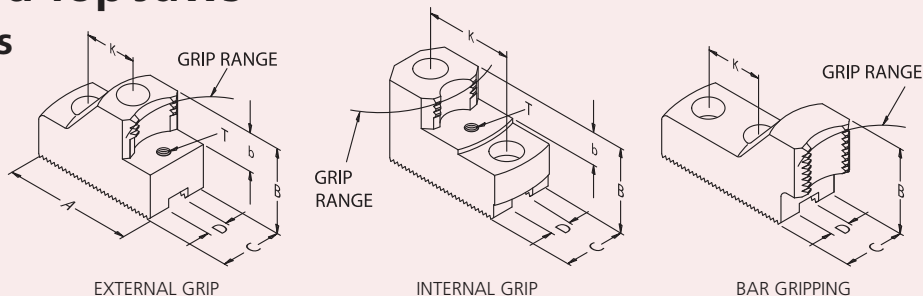

Serrated Hard Top Jaws

To suit • Forkardt Chuck Series KT

CHUCK Ø	TYPE	EXTERNAL GRIP RANGES	EXTERNAL GRIP JAW PART No	INTERNAL GRIP RANGES	INTERNAL GRIP JAW PART No	B	C	D	K	b	T	SERRATION
160	KT 160	15 - 29	KJ 16(Bar Jaw)			39	40	17	19			1/16" x 90°
		34 - 50	IA 03	55 - 68	JA 05	49	40	17	19	20	M6	
		50 - 70	IA 05	75 - 90	JA 07							
		70 - 92	IA 07	95 - 111	JA 09							
		92 - 114	IA 09	117 - 132	JA 11							
		114 - 132	IA 11									
200	KT 200	19 - 42	KJ 20(Bar Jaw)			49	40	17	22			1/16" x 90°
		34 - 59	IB 04	57 - 91	JB 06	49	40	17	22	20	M6	
		53 - 86	IB 05	88 - 123	JB 09							
		80 - 115	IB 08	119 - 154	JB 12							
		109 - 144	IB 11									
		138 - 174	IB 14									
250	KT250	22 - 63	KJ 26(Bar Jaw)			49	50	21	25			1/16" x 90°
		40 - 88	IC 05	81 - 106	JC 08	59	50	21	25	25	M8	
		80 - 133	IC 08	106 - 160	JC 10							
		129 - 184	IC 13	156 - 211	JC 15							
		180 - 235	IC 18									
315	KT 315	29 - 110	KJ 32(Bar Jaw)			49	50	21	25			1/16" x 90°
		40 - 150	IC 05	81 - 169	JC 08	59	50	21	25	25	M8	
		80 - 195	IC 08	106 - 223	JC 10							
		129 - 247	IC 13	156 - 274	JC 15							
		180 - 298	IC 18									
400	KT 400	40 - 95	KJ 40(Bar Jaw)			59	60	25.5	35			3/32" x 90°
		54 - 141	ID 06	96 - 187	JD 10	79	60	25.5	35	33	M8	
		102 - 228	ID 13	137 - 266	JD 17							
		186 - 315	ID 21	214 - 345	JD 25							
		274 - 405	ID 30	298 - 424	JD 33							
500	KT 500	54 - 239	ID 06	96 - 285	JD 10	79	60	25.5	35	33	M8	3/32" x 90°
		102 - 327	ID 13	137 - 365	JD 17							
		186 - 414	ID 21	214 - 444	JD 25							
		274 - 504	ID 30	293 - 524	JD 33							
630	KT 630	54 - 368	ID 06	96 - 414	JD 10	79	60	25.5	35	33	M8	3/32" x 90°
		102 - 456	ID 13	137 - 494	JD 17							
		186 - 544	ID 21	214 - 574	JD 25							
		274 - 634	ID 30	293 - 653	JD 33							

Adjustagrip Jaws are available on request in special sizes or to suit other chuck types.

Adjustagrip Hard Top Jaws

To suit Power Chucks
90° SERRATIONS

Material:

- Steel: 590M17

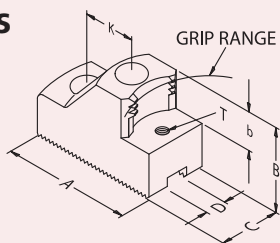

EXTERNAL GRIP

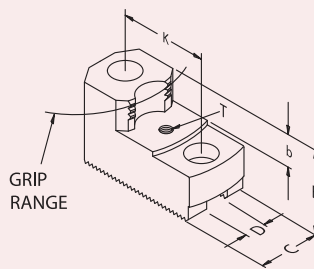

INTERNAL GRIP

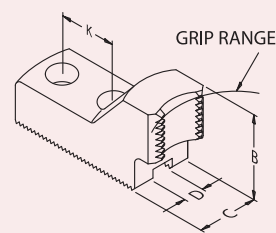

BAR GRIPPING

To suit • Forkardt Chuck Series NH/NHF

CHUCK Ø	TYPE	EXTERNAL GRIP RANGES	EXTERNAL GRIP JAW PART No	INTERNAL GRIP RANGES	INTERNAL GRIP JAW PART No	B	C	D	K	b	T	SERRATION
160	NH 160	25 - 40	KJ 16 (Bar Jaw)			39	40	17	19			1/16" x 90°
	NHF 160	36 - 58	IA 03	56 - 79	JA 05	49	40	17	19	20	M6	
		54 - 77	IA 05	78 - 101	JA 07							
		76 - 99	IA 07	98 - 122	JA 09							
		98 - 121	IA 09	120 - 144	JA 11							
120 - 144	IA 11											
175	NH 175	25 - 40	KJ 16 (Bar Jaw)			39	40	17	19			1/16" x 90°
	NHF 175	44 - 73	IA 03	64 - 93	JA 05	49	40	17	19	20	M6	
		62 - 92	IA 05	86 - 116	JA 07							
		84 - 114	IA 07	107 - 137	JA 09							
		106 - 136	IA 09	128 - 159	JA 11							
128 - 159	IA 11											
200	NH 200	19 - 55	KJ 20 (Bar Jaw)			49	40	17	22			1/16" x 90°
	NHF 200	34 - 72	IB 04	58 - 104	JB 06	49	40	17	22	20	M6	
		55 - 99	IB 05	89 - 136	JB 09							
		82 - 128	IB 08	120 - 167	JB 12							
		110 - 157	IB 11									
140 - 187	IB 14											
250	NH 250	22 - 63	KJ 26 (Bar Jaw)			49	50	21	25			1/16" x 90°
	NHF 250	40 - 88	IC 05	81 - 106	JC 08	59	50	21	25	25	M8	
		80 - 133	IC 08	106 - 160	JC 10							
		129 - 183	IC 13	156 - 211	JC 15							
		179 - 234	IC 18									
315	NH 315	31 - 110	KJ 32 (Bar Jaw)			49	50	21	25			1/16" x 90°
	NHF 315	34 - 122	IC 04	81 - 177	JC 08	59	50	21	25	25	M8	
		60 - 158	IC 05	131 - 231	JC 10							
		104 - 203	IC 08	181 - 282	JC 15							
		154 - 254	IC 13									
205 - 306	IC 18											
400	NH 400	40 - 100	KJ 40 (Bar Jaw)			59	60	25.5	35			3/32" x 90°
	NHF 400	54 - 143	ID 06	96 - 189	JD 10	79	60	25.5	35	33	M8	
		128 - 230	ID 13	164 - 267	JD 17							
		213 - 317	ID 21	242 - 347	JD 25							
		301 - 406	ID 30	321 - 426	JD 33							
500	NH 500	76 - 239	ID 06	120 - 285	JD 10	79	60	25.5	35	33	M8	3/32" x 90°
		160 - 327	ID 13	197 - 365	JD 17							
		246 - 414	ID 21	275 - 444	JD 25							
		335 - 504	ID 30	355 - 524	JD 33							
630	NH 630	98 - 346	ID 06	143 - 411	JD 10	79	60	25.5	35	33	M8	3/32" x 90°
		184 - 453	ID 13	221 - 490	JD 17							
		270 - 540	ID 21	300 - 570	JD 25							
		359 - 630	ID 30									

Adjustagrip Hard Top Jaws

To suit Power Chucks
90° SERRATIONS

Material:

- Steel: 590M17

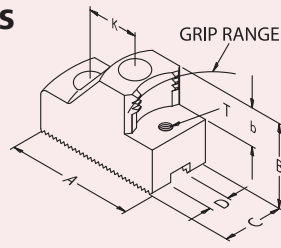

EXTERNAL GRIP

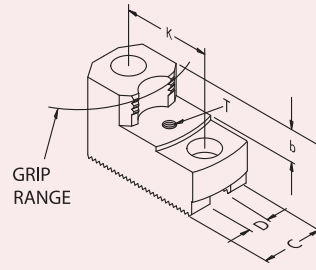

INTERNAL GRIP

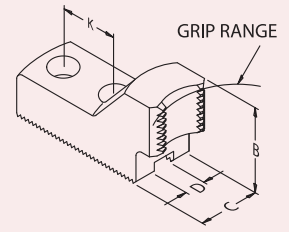

BAR GRIPPING

Serrated Hard Top Jaws

To suit • Forkardt Chuck Series QLC

CHUCK Ø	TYPE	EXTERNAL GRIP RANGES	EXTERNAL GRIP JAW PART No	INTERNAL GRIP RANGES	INTERNAL GRIP JAW PART No	B	C	D	K	b	T	SERRATION
160	QLC 160	18 - 55	KJ 16 (Bar Jaw)			39	40	17	19			1/16" x 90°
		37 - 72	IA 03	57 - 93	JA 05	49	40	17	19	20	M6	
		55 - 91	IA 05	79 - 115	JA 07							
		77 - 114	IA 07	99 - 137	JA 09							
		98 - 136	IA 09	120 - 158	JA 11							
		120 - 158	IA 11									
200	QLC 200	33 - 89	KJ 20 (Bar Jaw)			49	40	17	22			1/16" x 90°
		51 - 106	IA 03	72 - 127	JA 05	49	40	17	19	20	M6	
		70 - 125	IA 05	94 - 149	JA 07							
		92 - 147	IA 07	115 - 171	JA 09							
		114 - 170	IA 09	137 - 193	JA 11							
		137 - 193	IA 11									
250	QLC250	28 - 76	KJ 26 (Bar Jaw)			49	50	21	25			1/16" x 90°
		35 - 66	IC 04	81 - 120	JC 08	59	50	21	25	25	M8	
		51 - 101	IC 05	120 - 173	JC 10							
		95 - 146	IC 08	172 - 224	JC 15							
		145 - 197	IC 13									
		196 - 248	IC 18									
315	QLC 315	33 - 128	KJ 32 (Bar Jaw)			49	50	21	25			1/16" x 90°
		35 - 127	IC 04	81 - 181	JC 08	59	50	21	25	25	M8	
		63 - 162	IC 05	134 - 235	JC 10							
		107 - 207	IC 08	185 - 286	JC 15							
		157 - 259	IC 13									
		209 - 310	IC 18									
400	QLC 400	40 - 96	KJ 40 (Bar Jaw)			59	60	25.5	35			3/32" x 90°
		55 - 140	ID 06	97 - 187	JD 10	79	60	25.5	35	33	M8	
		131 - 228	ID 13	166 - 265	JD 17							
		215 - 315	ID 21	244 - 344	JD 25							
		304 - 404	ID 30									

Adjustagrip Jaws are available on request in special sizes or to suit other chuck types.

Adjustagrip Hard Top Jaws

To suit Power Chucks
90° SERRATIONS

Material:

- Steel: 590M17

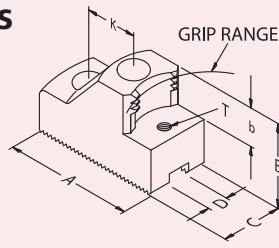

EXTERNAL GRIP

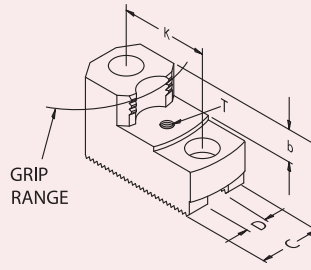

INTERNAL GRIP

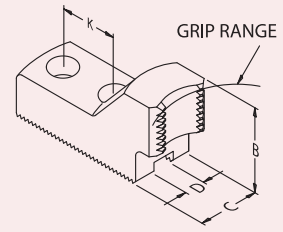

BAR GRIPPING

To suit • Forkardt Chuck Series QLC LS

CHUCK Ø	TYPE	EXTERNAL GRIP RANGES	EXTERNAL GRIP JAW PART No	INTERNAL GRIP RANGES	INTERNAL GRIP JAW PART No	B	C	D	K	b	T	SERRATION
160	QLC LS	22 - 35	KJ 16 (Bar Jaw)			39	40	17	19			1/16" x 90°
	160	40 - 56	IA 03	60 - 74	JA 05	49	40	17	19	20	M6	
		58 - 75	IA 05	82 - 96	JA 07							
		79 - 98	IA 07	103 - 117	JA 09							
		101 - 120	IA 09	124 - 139	JA 11							
		123 - 140	IA 11									
200	QLC LS	25 - 80	KJ 16 (Bar Jaw)			49	40	17	19			1/16" x 90°
	200	43 - 98	IA 03	64 - 118	JA 05	49	40	17	19	20	M6	
		62 - 116	IA 05	86 - 141	JA 07							
		84 - 139	IA 07	107 - 162	JA 09							
		106 - 161	IA 09	128 - 184	JA 11							
		128 - 184	IA 11									
250	QLC LS	23 - 74	KJ 26 (Bar Jaw)			49	50	21	25			1/16" x 90°
	250	35 - 65	IC 04	81 - 117	JC 08	59	50	21	25	25	M8	
		43 - 99	IC 05	112 - 171	JC 10							
		86 - 144	IC 08	162 - 222	JC 15							
		135 - 195	IC 13									
		186 - 246	IC 18									
315	QLC LS	71 - 132	KJ 32 (Bar Jaw)			49	50	21	25			1/16" x 90°
	315	70 - 131	IC 04	123 - 185	JC 08	59	50	21	25	25	M8	
		105 - 166	IC 05	177 - 239	JC 10							
		150 - 211	IC 08	228 - 290	JC 15							
		200 - 263	IC 13									
		252 - 314	IC 18									

Adjustagrip Jaws are available on request in special sizes or to suit other chuck types.

Adjustagrip Hard Top Jaws

To suit Power Chucks
90° SERRATIONS

Material:

- Steel: 590M17

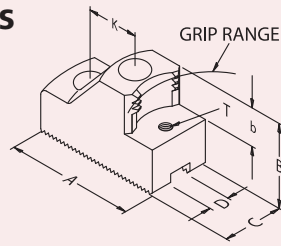

EXTERNAL GRIP

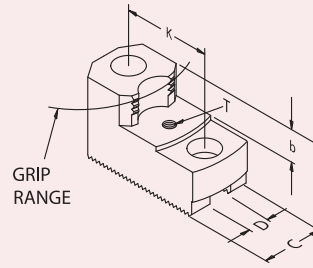

INTERNAL GRIP

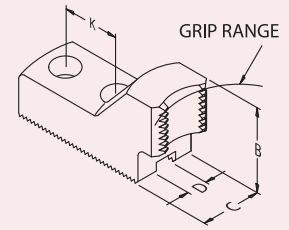

BAR GRIPPING

Serrated Hard Top Jaws

To suit • RÖHM Chuck Series KFD

CHUCK Ø	TYPE	EXTERNAL GRIP RANGES	EXTERNAL GRIP JAW PART No	INTERNAL GRIP RANGES	INTERNAL GRIP JAW PART No	B	C	D	K	b	T	SERRATION
160	KFD 160	14 - 40	KJ 16(Bar Jaw)	55 - 82 71 - 104 92 - 125 113 - 147	JA 05 JA 07 JA 09 JA 11	39	40	17	19	20	M6	1/16" x 90°
		34 - 61	IA 03			49	40	17	19			
		48 - 80	IA 05									
		70 - 102	IA 07									
		91 - 124	IA 09									
		11 - 147	IA 11									
200	KFD 200	19 - 56	KJ 20(Bar Jaw)	62 - 105 93 - 137 124 - 169	JB 06 JB 09 JB 12	49	40	17	22	20	M6	1/16" x 90°
		34 - 73	IB 04			49	40	17	22			
		58 - 100	IB 05									
		86 - 129	IB 08									
		115 - 159	IB 11									
		144 - 188	IB 14									
250	KFD 250	24 - 80	KJ 26(Bar Jaw)	81 - 128 117 - 182 167 - 233	JC 08 JC 10 JC 15	49	50	21	25	25	M8	1/16" x 90°
		47 - 109	IC 05			59	50	21	25			
		91 - 155	IC 08									
		140 - 205	IC 13									
		191 - 257	IC 18									
315	KFD 315	30 - 110	KJ 32(Bar Jaw)	81 - 186 129 - 240 180 - 291	JC 08 JC 10 JC 15	49	50	21	25	25	M8	1/16" x 90°
		58 - 167	IC 05			59	50	21	25			
		152 - 263	IC 13									
		203 - 315	IC 18									
400	KFD 400	40 - 110	KJ 40(Bar Jaw)	96 - 203 159 - 282 237 - 361	JD 10 JD 17 JD 25	59	60	25.5	35	33	M8	3/32" x 90°
		54 - 157	ID 06			79	60	25.5	35			
		123 - 245	ID 13									
		208 - 332	ID 21									
		296 - 421	ID 30									
500	KFD 500	54 - 259	ID 06	96 - 306 170 - 385 248 - 465	JD 10 JD 17 JD 25	79	60	25.5	35	33	M8	3/32" x 90°
		134 - 348	ID 13									
		219 - 435	ID 21									
		308 - 525	ID 30									
630	KFD 630	71 - 387	ID 06	115 - 433 192 - 513 270 - 592	JD 10 JD 17 JD 25	79	60	25.5	35	33	M8	3/32" x 90°
		156 - 475	ID 13									
		241 - 563	ID 21									
		330 - 652	ID 30									

Adjustagrip Jaws are available on request in special sizes or to suit other chuck types.

Adjustagrip Hard Top Jaws

To suit Power Chucks
90° SERRATIONS

Material:

- Steel: 590M17

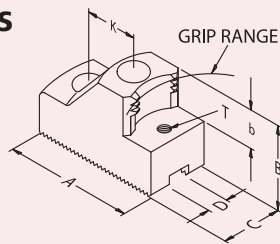

EXTERNAL GRIP

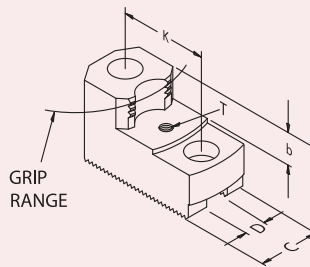

INTERNAL GRIP

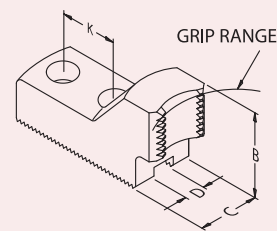

BAR GRIPPING

To suit • RÖHM Chuck Series KFD-HS

CHUCK Ø	TYPE	EXTERNAL GRIP RANGES	EXTERNAL GRIP JAW PART No	INTERNAL GRIP RANGES	INTERNAL GRIP JAW PART No	B	C	D	K	b	T	SERRATION
200	KFD-HS 200	25 - 71	KJ 16(Bar Jaw)			39	40	17	19			1/16" x 90°
		43 - 88	IA 03	64 - 109	JA 05	49	40	17	19	20	M6	
		62 - 107	IA 05	86 - 131	JA 07							
		106 - 152	IA 09	106 - 153	JA 09							
		128 - 174	IA 11	128 - 174	JA 11							
250	KFD-HS 250	21 - 94	KJ 20(Bar Jaw)			49	40	17	22			1/16" x 90°
		38 - 111	IB 04	68 - 143	JB 06	49	40	17	22	20	M6	
		64 - 138	IB 05	100-175	JB 09							
		121 - 197	IB 11	131 - 207	JB 12							
315	KFD-HS 315	30 - 110	KJ 32(Bar Jaw)			49	50	21	25			1/16" x 90°
		40 - 156	IC 05	81 - 175	JC 08	59	50	21	25	25	M8	
		83 - 201	IC 08	109 - 229	JC 10							
400	KFD-HS 400	40 - 110	KJ 40(Bar Jaw)			59	60	25.5	35			3/32" x 90°
		56 - 142	ID 06	97 - 188	JD 10	79	60	25.5	35	33	M8	
		137 - 230	ID 13	173 - 267	JD 17							
		222 - 317	ID 21	251 - 346	JD 25							
500	KFD-HS 500	311 - 406	ID 30	330 - 423	JD 33							
		56 - 240	ID 06	97 - 287	JD 10	79	60	25.5	35	33	M8	3/32" X 90°
		137 - 329	ID 13	173 - 366	JD 17							
		311 - 506	ID 30	251 - 446	JD 25							
		330 - 533	JD 33									

Workpiece Height Pins

See page 165



Adjustagrip Jaws are available on request in special sizes or to suit other chuck types.

Adjustagrip Hard Top Jaws

To suit Power Chucks
90° SERRATIONS

Material:

- Steel: 590M17

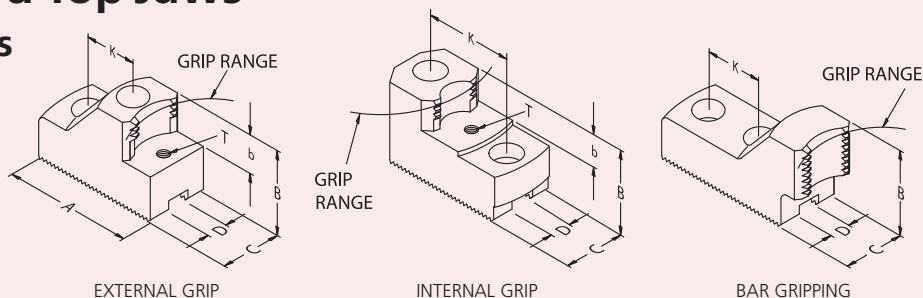

Serrated Hard Top Jaws

To suit • Schunk Chuck Series TH/THF

CHUCK Ø	TYPE	EXTERNAL GRIP RANGES	EXTERNAL GRIP JAW PART No	INTERNAL GRIP RANGES	INTERNAL GRIP JAW PART No	B	C	D	K	b	T	SERRATION
160	TH 165	23 - 59	KJ 16(Bar Jaw)			39	40	17	19			1/16" x 90°
	THF 165	41 - 76	IA 03	61 - 97	JA 05	49	40	17	19	20	M6	
		60 - 95	IA 05	83 - 120	JA 07							
		81 - 118	IA 07	104 - 141	JA 09							
		103 - 140	IA 09	125 - 162	JA 11							
		125 - 162	IA 11									
200	TH 210	23 - 72	KJ 20(Bar Jaw)			49	40	17	22			1/16" x 90°
	THF 210	34 - 77	IB 03	70 - 121	JB 06	49	40	17	22	20	M6	
		39 - 89	IB 04	102 - 153	JB 09							
		66 - 116	IB 05	133 - 185	JB 12							
		94 - 145	IB 08									
		123 - 175	IB 11									
152 - 205	IB 14											
250	TH 250	28 - 93	KJ 26(Bar Jaw)			49	50	21	25			1/16" x 90°
	THF 250	34 - 83	IC 04	81 - 136	JC 08	59	50	21	25	25	M8	
		52 - 118	IC 05	122 - 190	JC 10							
		96 - 163	IC 08	172 - 241	JC 15							
		145 - 214	IC 13									
		196 - 265	IC 18									
315	TH 315	50 - 110	KJ 32(Bar Jaw)			49	50	21	25			1/16" x 90°
	THF 315	49 - 136	IC 04	100 - 191	JC 08	59	50	21	25	25	M8	
		82 - 172	IC 05	154 - 244	JC 10							
		127 - 217	IC 08	205 - 296	JC 15							
		177 - 268	IC 13									
		229 - 320	IC 18									
400	TH 400	72 - 110	KJ 40(Bar Jaw)			59	60	25.5	35			3/32" x 90°
	THF 400	69 - 154	ID 06	113 - 201	JD 10	79	60	25.5	35	33	M8	
		153 - 242	ID 13	189 - 279	JD 17							
		238 - 329	ID 21	267 - 359	JD 25							
		327 - 418	ID 30									
500	TH 500	115 - 272	ID 06	161 - 318	JD 10	79	60	25.5	35	33	M8	3/32" x 90°
	THF 500	202 - 360	ID 13	239 - 397	JD 17							
		289 - 447	ID 21	318 - 477	JD 25							
		378 - 537	ID 30									

Adjustagrip Jaws are available on request in special sizes or to suit other chuck types.

Adjustagrip Hard Top Jaws

To suit Power Chucks
90° SERRATIONS

Material:

- Steel: 590M17

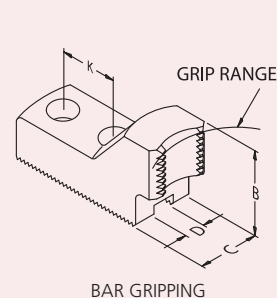
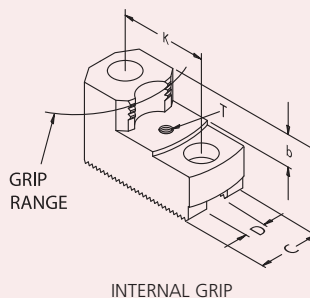
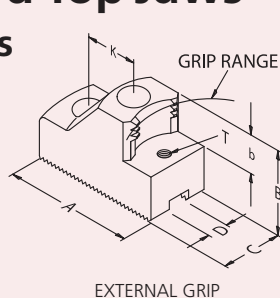

To suit • Schunk Chuck Series HSG

CHUCK Ø	TYPE	EXTERNAL GRIP RANGES	EXTERNAL GRIP JAW PART No	INTERNAL GRIP RANGES	INTERNAL GRIP JAW PART No	B	C	D	K	b	T	SERRATION
200	HSG 200	49 - 96	KJ 16(Bar Jaw)			39	40	17	19			1/16" x 90°
		67 - 113	IA 03	88 - 134	JA 05	49	40	17	19	20	M6	
		86 - 132	IA 05	110 - 156	JA 07							
		109 - 154	IA 07	132 - 178	JA 09							
		131 - 177	IA 09	153 - 200	JA 11							
		153 - 200	IA 11									
250	HSG 250	77 - 125	KJ 16(Bar Jaw)			39	40	17	19			1/16" x 90°
		95 - 142	IA 03	115 - 163	JA 05	49	40	17	19	20	M6	
		114 - 161	IA 05	138 - 185	JA 07							
		136 - 183	IA 07	159 - 207	JA 09							
		158 - 206	IA 09	181 - 228	JA 11							
		181 - 228	IA 11									
315	HSG 315	61 - 137	KJ 32(Bar Jaw)			49	50	21	25			1/16" x 90°
		60 - 135	IC 04	112 - 190	JC 08	59	50	21	25	25	M8	
		94 - 170	IC 05	166 - 243	JC 10							
		139 - 216	IC 08	218 - 295	JC 15							
		190 - 267	IC 13									
		241 - 319	IC 18									
400	HSG 400	40 - 112	KJ 40(Bar Jaw)			59	60	25.5	35			3/32" x 90°
		64 - 157	ID 06	108 - 203	JD 10	79	60	25.5	35	33	M8	
		148 - 245	ID 13	184 - 282	JD 17							
		233 - 332	ID 21	262 - 361	JD 25							
		322 - 421	ID 30									
500	HSG 500	54 - 202	KJ 40(Bar Jaw)			59	60	25.5	35			3/32" x 90°
		96 - 247	ID 06	141 - 294	JD 10	79	60	25.5	35	33	M8	
		182 - 336	ID 13	219 - 373	JD 17							
		268 - 423	ID 21	298 - 453	JD 25							
		357 - 512	ID 30									

Adjustagrip Jaws are available on request in special sizes or to suit other chuck types.

Adjustagrip Hard Top Jaws

To suit Power Chucks
90° SERRATIONS

Material:

- Steel: 590M17

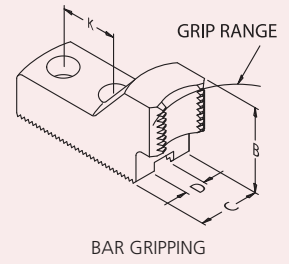
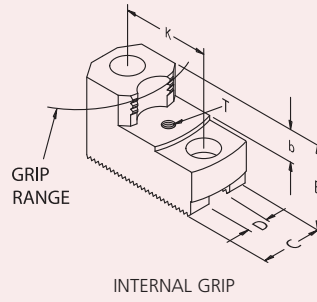
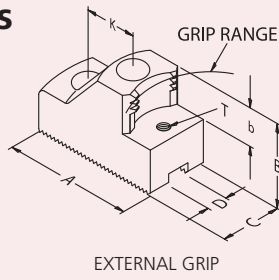

Serrated Hard Top Jaws

To suit • Schunk Chuck Series HSL

CHUCK Ø	TYPE	EXTERNAL GRIP RANGES	EXTERNAL GRIP JAW PART No	INTERNAL GRIP RANGES	INTERNAL GRIP JAW PART No	B	C	D	K	b	T	SERRATION
165	HSL 165	27 - 55	KJ 16(Bar Jaw)	66 - 93 88 - 115 109 - 137 130 - 158	JA 05 JA 07 JA 09 JA 11	39	40	17	19	20	M6	1/16" x 90°
		45 - 72	IA 03			49	40	17	19			
		64 - 91	IA 05									
		86 - 114	IA 07									
		108 - 136	IA 09									
		130 - 158	IA 11									
210	HSL 210	41 - 87	KJ 16(Bar Jaw)	80 - 125 102 - 148 123 - 169 145 - 191	JA 05 JA 07 JA 09 JA 11	39	40	17	19	20	M6	1/16" x 90°
		59 - 104	IA 03			49	40	17	19			
		78 - 123	IA 05									
		100 - 146	IA 07									
		122 - 168	IA 09									
		145 - 191	IA 11									
250	HSL250	27 - 85	KJ 26(Bar Jaw)	81 - 128 121 - 182 171 - 233	JC 08 JC 10 JC 15	49	50	21	25	25	M8	1/16" x 90°
		35 - 75	IC 04			59	50	21	25			
		51 - 110	IC 05									
		95 - 155	IC 08									
		144 - 206	IC 13									
		195 - 257	IC 18									
315	HSL 315	46 - 127	KJ 32(Bar Jaw)	96 - 180 150 - 234 201 - 285	JC 08 JC 10 JC 15	49	50	21	25	25	M8	1/16" x 90°
		46 - 126	IC 04			59	50	21	25			
		78 - 161	IC 05									
		123 - 206	IC 08									
		174 - 257	IC 13									
		225 - 309	IC 18									

Workpiece Height Pins



Adjustagrip Jaws are available on request in special sizes or to suit other chuck types.

Adjustagrip Hard Top Jaws

To suit Power Chucks
90° SERRATIONS

Material:

- Steel: 590M17

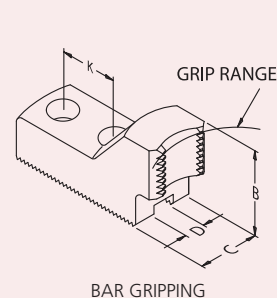
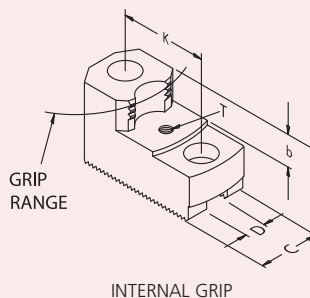
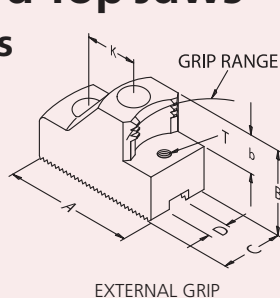

To suit • Schunk Chuck Series Rota NC/NCF

CHUCK Ø	TYPE	EXTERNAL GRIP RANGES	EXTERNAL GRIP JAW PART No	INTERNAL GRIP RANGES	INTERNAL GRIP JAW PART No	B	C	D	K	b	T	SERRATION
160	ROTANC165	18 - 47	KJ 16(Bar Jaw)			39	40	17	19			1/16" x 90°
	ROTANCF165	36 - 64	IA 03	57 - 85	JA 05	49	40	17	19	20	M6	
		55 - 83	IA 05	78 - 107	JA 07							
		76 - 106	IA 07	99 - 129	JA 09							
		98 - 128	IA 09	120 - 150	JA 11							
		120 - 150	IA 11									
200	ROTANC210	27 - 64	KJ 20(Bar Jaw)			49	40	17	22			1/16" x 90°
	ROTANCF210	35 - 69	IB 03	75 - 113	JB 06	49	40	17	22	20	M6	
		44 - 81	IB 04	107 - 145	JB 09							
		71 - 108	IB 05	138 - 176	JB 12							
		99 - 137	IB 08									
		128 - 166	IB 11									
158 - 196	IB 14											
250	ROTANC250	26 - 85	KJ 26(Bar Jaw)			49	50	21	25			1/16" x 90°
	ROTANCF250	35 - 75	IC 04	81 - 128	JC 08	59	50	21	25	25	M8	
		49 - 110	IC 05	119 - 182	JC 10							
		93 - 155	IC 08	169 - 233	JC 15							
		142 - 206	IC 13									
		193 - 257	IC 18									
315	ROTANC315	41 - 137	KJ 32(Bar Jaw)			49	50	21	25			1/16" x 90°
	ROTANCF315	41 - 135	IC 04	90 - 190	JC 08	59	50	21	25	25	M8	
		72 - 170	IC 05	144 - 243	JC 10							
		117 - 215	IC 08	195 - 295	JC 15							
		167 - 267	IC 13									
		218 - 318	IC 18									
400	ROTANC400	41 - 117	KJ 40(Bar Jaw)			59	60	25.5	35			3/32" x 90°
	ROTANCF400	60 - 162	ID 06	103 - 208	JD 10	79	60	25.5	35	33	M8	
		143 - 249	ID 13	179 - 287	JD 17							
		228 - 336	ID 21	257 - 366	JD 25							
		317 - 426	ID 30	336 - 445	JD 33							
500	ROTANC500	111 - 259	ID 06	157 - 306	JD 10	79	60	25.5	35	33	M8	3/32" x 90°
	ROTANCF500	198 - 347	ID 13	234 - 385	JD 17							
		284 - 435	ID 21	313 - 464	JD 25							
		373 - 524	ID 30	393 - 544	JD 33							

Adjustagrip Jaws are available on request in special sizes or to suit other chuck types.

Adjustagrip Hard Top Jaws

To suit Power Chucks
90° SERRATIONS

Material:

- Steel: 590M17

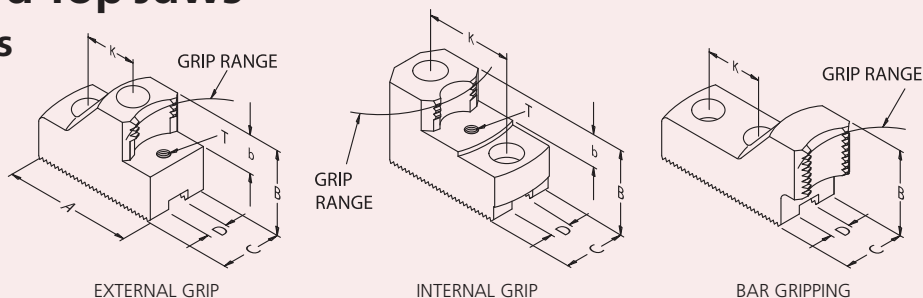

Serrated Hard Top Jaws

To suit • SMW-Autoblok Chucks Series BH-D

CHUCK Ø	TYPE	EXTERNAL GRIP RANGES	EXTERNAL GRIP JAW PART No	INTERNAL GRIP RANGES	INTERNAL GRIP JAW PART No	B	C	D	K	b	T	SERRATION
210	BH-D 210	25 - 56	KJ 20 (Bar Jaw)	58 - 102 89 - 134 120 - 165	JB 06 JB 09 JB 12	49	40	17	22	20	M6	1/16" x 90°
		34 - 70	IB 04			49	40	17	22			
		55 - 97	IB 05									
		82 - 126	IB 08									
		111 - 156	IB 11									
140 - 185	IB 14											
250	BH-D 250	30 - 70	KJ 26 (Bar Jaw)	81 - 114 114 - 166 165 - 217	JC 08 JC 10 JC 15	49	50	21	25	25	M8	1/16" x 90°
		45 - 94	IC 05			59	50	21	25			
		89 - 139	IC 08									
		138 - 189	IC 13									
		188 - 241	IC 18									
315	BH-D 315	67 - 110	KJ 32 (Bar Jaw)	89 - 172 144 - 226 194 - 277	JC 08 JC 10 JC 15	49	50	21	25	25	M8	1/16" x 90°
		50 - 118	IC 04			59	50	21	25			
		117 - 198	IC 08									
		167 - 250	IC 13									
		218 - 301	IC 18									

To suit • SMW-Autoblok Chucks Series BB-D

CHUCK Ø	TYPE	EXTERNAL GRIP RANGES	EXTERNAL GRIP JAW PART No	INTERNAL GRIP RANGES	INTERNAL GRIP JAW PART No	B	C	D	K	b	T	SERRATION
210	BB-D 210	19 - 53	KJ20 (Bar Jaw)	72 - 105 104 - 137 135 - 168	JB 06 JB 09 JB 12	49	40	17	22	20	M6	1/16" x 90°
		41 - 73	IB04			49	40	17	22			
		68 - 100	IB05									
		96 - 129	IB08									
		125 - 158	IB11									
155 - 188	IB14											
250	BB-D 250	23 - 69	KJ26 (Bar Jaw)	81 - 113 124 - 167 175 - 218	JC 08 JC 10 JC 15	49	50	21	25	25	M8	1/16" x 90°
		54 - 98	IC05			59	50	21	25			
		98 - 140	IC08									
		147 - 190	IC13									
		198 - 242	IC18									
315	BB-D 315	41 - 110	KJ32 (Bar Jaw)	119 - 173 173 - 225 224 - 276	JC 08 JC 10 JC 15	49	50	21	25	25	M8	1/16" x 90°
		66 - 117	IC04			59	50	21	25			
		100 - 152	IC05									
		146 - 197	IC08									
		196 - 249	IC13									
248 - 300	IC18											

Adjustagrip Jaws are available on request in special sizes or to suit other chuck types.

Serrated Hard Top Jaws

60° SERRATIONS - REVERSIBLE TYPE

Material:

- Steel: 590M17 or 080M15
- Black Finish

Chuck Ø 110mm - 315mm



TYPE A

TYPE B

PART No.	JAW TYPE	A	B	C	D	K	S1	S2	SERRATIONS
GT 04	B	53	30	25	10	14	10		1.5mm x 60°
GT 05	B	57	32	25	10	18	13		1.5mm x 60°
GT 06	B	66	38	35	12	20	14		1.5mm x 60°
GT 07	A	68	50	35			11	11	
GT 08	A	86	50	35	14	25	11	11	1.5mm x 60°
GT 10	A	99	60	40	16	30	15	15	1.5mm x 60°
GT 12	B	98	60	50	18	30	22		1.5mm x 60°
GT 11	A	103	70	50			17	17	

AUTOSTRONG	HARDINGE (SURE GRIP)	HOWA	KITAGAWA	LEADER	PRATT BURNERD
N204;N205;	4" SURE-GRIP 5" SURE-GRIP		B204; N-04; AS04 B205;AS110 HJA-4; HL04; HOB-5; B-05		
N206;V206; NB206	6" SURE-GRIP	H3KT6	HJA5-6; HOS-6;N-06 HOB-6; AS-165; B206 B-160; HO-06; B-06; NL06 BB-06; HOH-160 HOH-206; HOH-06; B-07 N-160; B-106; BL206 BB206; BS306; DL06; ML06;	LC 165 KHF 165	165 CONSTANT GRIP 170 INTERNATIONAL 165 HIGH SPEED Q C
N208; V208; NB208	8" SURE-GRIP		B208; B-08; HOB-8 N-200;HOH-200; N-08 HOH-8; AS-210; NL08; HOS-8; HJA6-8 HOH-208; HO-8; HOH108; B-108; BB08; BL208 BB208; HG715-210 BS308; ML08; DL08;UVE160K	LC210 KHF 210	210 INTERNATIONAL 210 HIGH SPEED Q C
N210;V210; NB210	10" SURE-GRIP	H3KT10	B250; B-10; HOH-250 HOH-10K; B210; HOB-10 AS-250; N-250; N-10 HJA6-10; HJ8-10; HOS-10 HO-10; NL-10; B-110; UVE-K200; HOH110 UVE-200K; HOH-210; BL210; HG730-254; B210X BB210; BS310; UVE250K	LC250 KHF 250	254 CONSTANT GRIP 254 HIGH SPEED Q C 265 INTERNATIONAL
V212			B300;B-12;HOH-300; HOH-12K; N-300; N-12; HOB-12; HJA6-12; NL-12 HLA6-12; HLA8-15; HLA6-15; UVE315K		305 CONSTANT GRIP 305 HIGH SPEED Q C

Serrated Hard Top Jaws

60° SERRATIONS - REVERSIBLE TYPE

Material:

- Steel: 590M17 or 080M15
- Black Finish

Chuck Ø 110mm - 315mm

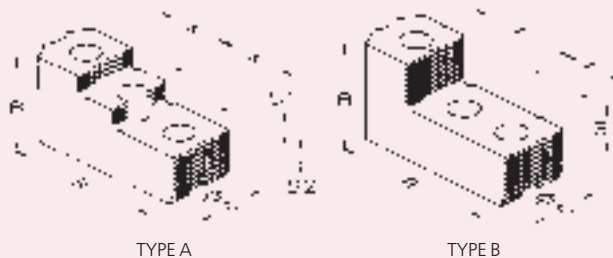

TYPE A

TYPE B

PART No.	JAW TYPE	A	B	C	D	K	S1	S2	SERRATIONS
GT 04	B	53	30	25	10	14	10		1.5mm x 60°
GT 05	B	57	32	25	10	18	13		1.5mm x 60°
GT 06	B	66	38	35	12	20	14		1.5mm x 60°
GT 07	A	68	50	35			11	11	
GT 08	A	86	50	35	14	25	11	11	1.5mm x 60°
GT 10	A	99	60	40	16	30	15	15	1.5mm x 60°
GT 12	B	98	60	50	18	30	22		1.5mm x 60°
GT 11	A	103	70	50			17	17	

RÖHM	SAMCHULLY (POWER GRIP)	SEOAM (ACE)	SCHUNK	SMW-AUTOBLOK	TONFOU
KFD-HE 130; KFN 105	HC-04 HS-04 HS-05	CAS-4; CAH-5			TF3B-04; TF3B-05
	HCH-05	CAS-5			
KFD-HE 170	HCH-06; HC06 HS-06; HH206 MH-206	CAH-6; CAS-6 CGH-6	ROTA NCD 165-185; ROTA NCK 165 ROTA NC/NCF 165; HSL 165; ROTA NCK plus 165; ROTA NC plus 185; ROTA NCF 185	AL-M 165; AN-M 165; BB-M 175; BH-M 165; BH-M FC 165; HB-M 165 HFKN-M 165; PB-M 165; PBI-M 165; AP-M 170; NT-M 170	TF3B-06; TF3X-6 VA-206;
KFD-HE 210	HCH-08; HC-08; HS-08; HH208 MH-208	CAH-8; CAS-8 CGH-8	ROTA NCD 210; ROTA NCK 210; ROTA NC/NCF 210; HSL 210; ROTA NCK plus 210; ROTA NC plus 215; ROTA NCF plus 215	AL-M 210; AN-M 210; BB-M 210; BH-M 210; BH-M FC 210; HB-M 210 HFKN-M 210; PB-M 210; PBI-M 210; AP-M 215; APL-M 215; NT-M 215	TF3B-08; TF3X-8 V-208; VA-208
KFD-HE 254	HCH-10; HC-10; HS-10 HH210 MH-210	CAH-10; CAS-10; CGH-10;	ROTA NCD 250; ROTA NCK 250; ROTA NC/NCF 250; HSL 250; ROTA NCK plus 250; ROTA NC plus 260; ROTA NCF plus 260	AL-M 250; AN-M 250; BB-M 250; BH-M 250; BH-M FC 250; HB-M 250; HFKN-M 260; PB-M 250; PBI-M 250; AP-M 260; APL-M 260; NT-M 260	TF3B-10; TF3X-10 V-210; VA-210;
	HC-12; HCH-12		ROTA NC/NCF 315; HSL 315		V-212; VA-212;

Serrated Hard Top Jaws

60° SERRATIONS - REVERSIBLE TYPE

Material:

- Steel: 590M17 or 080M15
- Black Finish

Chuck Ø 315mm - 800mm



TYPE A

TYPE B

PART No.	JAW TYPE	A	B	C	D	K	S1	S2	SERRATIONS
GT 13	B	98	60	50	21	30	22		1.5mm x 60°
GT 14	A	103	70	50			17	17	
GT 15	A	140	90	60	22	43	22	22	1.5mm x 60°
GT 21	B	178	90	60	25	60	40		3mm x 60°
GT 24	B	219	100	60	25	80	50		3mm x 60°

AUTOSTRONG	HARDINGE (SURE GRIP)	HOWA	KITAGAWA	LEADER	PRATT BURNERD
N212; NB212	12" SURE-GRIP	H3KT12	B212; BL212 BB212;	LC315 KHF 315	
N215;			B380; B-15; HOH-380; HOB-15; HOH-15K; B-450 B-18; HOB-18 HJ-380; HJA-18; HLA-18; HJA-8-21; UVE400K		380 INTERNATIONAL 380 HIGH SPEED Q C
V221;V224			HJ-450; HJ18; B-350; B-21; HJ-530; HJ-21; HOB-21; N-21; B-600; B-24; HJ-610; HJ24; N24; HOB24; UVE-LB500/630		460 CONSTANT GRIP 500 CONSTANT GRIP 610 CONSTANT GRIP 460 HIGH SPEED Q C 500 HIGH SPEED Q C 610 HIGH SPEED Q C
			HOB24; HJA24; HJ24; UVE-LB800		

Serrated Hard Top Jaws

60° SERRATIONS - REVERSIBLE TYPE

Material:

- Steel: 590M17 or 080M15
- Black Finish

Chuck Ø 315mm - 800mm



TYPE A

TYPE B

PART No.	JAW TYPE	A	B	C	D	K	S1	S2	SERRATIONS
GT 13	B	98	60	50	21	30	22		1.5mm x 60°
GT 14	A	103	70	50			17	17	
GT 15	A	140	90	60	22	43	22	22	1.5mm x 60°
GT 21	B	178	90	60	25	60	40		3mm x 60°
GT 24	B	219	100	60	25	80	50		3mm x 60°
GT 32	B	219	100	60	25.5	80	50		3mm x 60°

RÖHM	SAMCHULLY (POWER GRIP)	SEOAM (ACE)	SCHUNK	SMW-AUTOBLOK	TONFOU
KFD-HE 315	HS-12; HH212 MH212	CAH-12	ROTA NCD 315; ROTA NCK 315; HSL 315; ROTA NCK plus 315; ROTA NC plus 315; ROTA NCF plus 315	AL-M 315; AN-M 315; BB-M 305; BB-M 315; BH-M 315; BHM-FC 315; GH-M 400; HB-M 305; HB-M 315; HFKN-M 315; PB-M 315; PBI-M 315; RC-M 305; RC-M 315; RC-M 400; AP-M 315;	TF3B-12
	HCH-15; HCH-18	CAH-15; CAH-18;	ROTA NC/NCF 400; HSL 400		TF3B-15
	HC-21; HC-24; HCH-21; HCH-24	CAH-21			
	HCH-32				

Serrated Hard Top Jaws

60° SERRATIONS - REVERSIBLE TYPE

Material:

- Steel: 590M17 or 080M15
- Black Finish

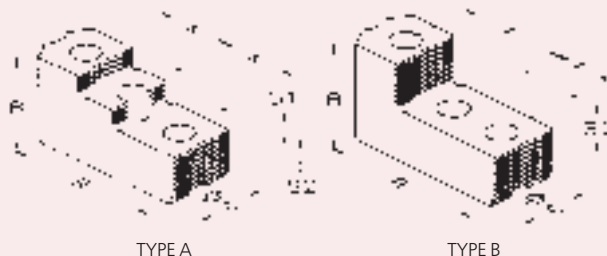

TYPE A

TYPE B

To suit • Howa Power Chucks

PART No.	JAW TYPE	A	B	C	D	K	S1	S2	SERRATIONS	CHUCK Ø	HOWA
GW 06	B	66	40	30	12	20	11		1.5mm x 60°	165Ø	H027M6 H037M6 H023M08
GW 08	B	83	40	40	16	25	13		1.5mm x 60°	210Ø	H027M8 H037M8 H023M 10
GW 10	B	98	50	40	18	30	15		1.5mm x 60°	254Ø	H027M 10 H037M 10 H023M12
GW 12	B	111	60	50	21	35	23		1.5mm x 60°	304Ø	H027M12 H037M12

To suit • MMK Matsumoto Power Chucks

THAME PART No.	JAW TYPE	A	B	C	D	K	S1	S2	SERRATIONS	CHUCK Ø	MMK MATSUMOTO
GT 05	B	57	32	25	10	18	13		1.5mm x 60°	135Ø	HXA5-6-34; HHA5-6; ZA5-6-40;
GU 06	A	65	35	30	11	20	9	9	1.5mm x 60°	165Ø	HA5-6; HH-6; HX-6; HJ-6; H-6; STC-6; ZA-5-6;
GT 08	A	86	50	35	14	25	11	11	1.5mm x 60°	210Ø	HA6-8; HX-8; H-8; HH-8; HJ-8; HHJ-8; STC-8; ZA-6-8-52;
GT 10	A	99	60	40	16	30	15	15	1.5mm x 60°	254Ø	HA6-10; HA8-10; ZA6-10-75; H-10; HX-10; HHL-10; HH-10; HHJ-10; HJ-10; HA8-11; STC-10;
GT 12	B	98	60	50	18	30	22		1.5mm x 60°	304Ø	HA8-12; HX-12; H-12; SH-12; HH-12; HHL-12; HJ-12; HHJ-12; ZA8-12-78; ZA8-12-85;
GU 15	A	140	90	60	22	44,5	22	22	3mm x 60°	380Ø 450Ø	HA11-15; HHL-15; H-15; HH-15; ZA11-15-120; HA11-18; H-18; HH-18;

Serrated Hard Top Jaws

90° SERRATIONS - REVERSIBLE TYPE

Material:

- Steel: 590M17 or 080M15
- Black Finish

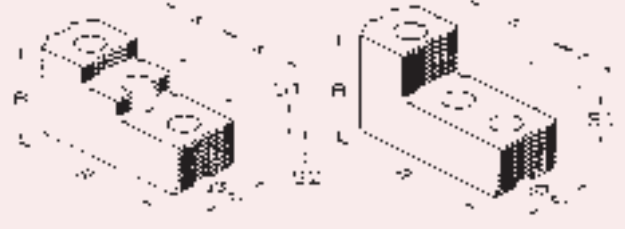

TYPE A

TYPE B

To suit • BERG KH Power Chucks

THAME PART No.	JAW TYPE	A	B	C	D	K	S1	S2	SERRATIONS	BERG
HB 211	A	50	34	24	8	14.3	6.5	6.5	1/16" x 90°	KH 110
HB 232	A	66.5	38	25	10	19	6.5	6.5	1/16" x 90°	KH 140; KH 160
HB 237	A	79	44	30	12	21	8	8	1/16" x 90°	KH 175; KH 200
HB 240	A	112	60	40	16	29	12	12	1/16" x 90°	KH 250; KH 315
HB 228	A	144	75	50	20	38	15	15	3/32" x 90°	KH 400; KH 500; KH 630

To suit • Gamet Power Chucks

THAME PART No.	JAW TYPE	A	B	C	D	K	S1	S2	SERRATIONS	GAMET
GR 16	B	65	35	30	11	18.5	17		1/16" x 90°	160N; 160MO; 160GO
GR 20	B	76	44	35	14	22	24		1/16" x 90°	215N; 215MO; 215GO
GR 28	B	94	51	44	20	28	24		1/16" x 90°	250/280N; 200MO; 200GO
GR 35	B	128	65	50	21	40	28		1/16" x 90°	350N; 350MO; 350GO

Serrated Hard Top Jaws

60° SERRATIONS - REVERSIBLE TYPE

Material:

- Steel: 590M17 or 080M15
- Black Finish

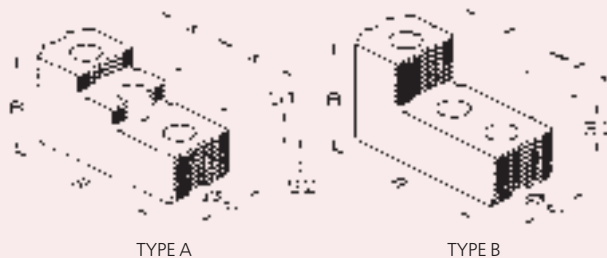

TYPE A

TYPE B

To suit • Howa Power Chucks

THAME PART No.	JAW TYPE	A	B	C	D	K	S1	S2	SERRATIONS	CHUCK Ø	HOWA
GW 06	B	66	40	30	12	20	11		1.5mm x 60°	165Ø	H027M6 H037M6 H023M08
GW 08	B	83	40	40	16	25	13		1.5mm x 60°	210Ø	H027M8 H037M8 H023M 10
GW 10	B	98	50	40	18	30	15		1.5mm x 60°	254Ø	H027M 10 H037M 10 H023M12
GW 12	B	111	60	50	21	35	23		1.5mm x 60°	304Ø	H027M12 H037M12

To suit • MMK Matsumoto Power Chucks

THAME PART No.	JAW TYPE	A	B	C	D	K	S1	S2	SERRATIONS	CHUCK Ø	MMK MATSUMOTO
GT 05	B	57	32	25	10	18	13		1.5mm x 60°	135Ø	HXA5-6-34; HHXA5-6; ZA5-6-40;
GU 06	A	65	35	30	11	20	9	9	1.5mm x 60°	165Ø	HA5-6; HH-6; HX-6; HJ-6; H-6; STC-6; ZA-5-6;
GT 08	A	86	50	35	14	25	11	11	1.5mm x 60°	210Ø	HA6-8; HX-8; H-8; HH-8; HJ-8; HHJ-8; STC-8; ZA-6-8-52;
GT 10	A	99	60	40	16	30	15	15	1.5mm x 60°	254Ø	HA6-10; HA8-10; ZA6-10-75; H-10; HX-10; HHL-10; HH-10; HHJ-10; HJ-10; HA8-11; STC-10;
GT 12	B	98	60	50	18	30	22		1.5mm x 60°	304Ø	HA8-12; HX-12; H-12; SH-12; HH-12; HHL-12; HJ-12; HHJ-12; ZA8-12-78; ZA8-12-85;
GU 15	A	140	90	60	22	44,5	22	22	3mm x 60°	380Ø 450Ø	HA11-15; HHL-15; H-15; HH-15; ZA11-15-120; HA11-18; H-18; HH-18;

AUTOBLOK & SMW-AUTOBLOK	BERG	FORKARDT	GAMET
IDN 170, HDB 170; IDL 170; HDN 170; GHDN 165; GHD-FC 165; AN-D 165; AL-D 16 HFKN-D 165; HYDN—S 180; PB-D 165 PBI-D 165; BB-D 175; BHD-FC 165; HB-D 165			MAC 165/170 DE 170 GA 160/170
AL-D 210; AN-D 210; BB-D 210; BH-D 210 BH-D FC 210; CD 200; GHD-FC 210 GHDN 210; HB-210; HDB 220; HDL 200 IDN 200; IDN 220; IDL 200; HDN 200; HDN 220; HDN 250S; PB-D 210; PBI-D 210 RC-D 210;	KF160; HES160; KHFF 200 KF 200; HES 200; HESF 160 HESF 200;	KGG 160/175/200; KGHF 160/175/200 KG200; KL160; KLNC 200; KP 200 KS 160/200/250; KSF 175/200 KSH 160/200; KSHF 200; KSPS 160/200 KTG 160/200; KTGF 200 KTH 160/ 175/ 200; KTN 160/200 NH 160/175/200; NHF 160/175/200 QLC 160/175/200; QLC-KS 200; QLC-LS 160/200; QLC-AG 200; QLK 160 QLK 175/200; QLK-KS 200; UVE 160/200	MAC 200; MAC 220 DE 210; GA 210
AL-D 210; AN-D 210; BB-D 210; BH-D 210 BH-D FC 210; CD 200; GHD-FC 210 GHDN 210; HB-210; HDB 220; HDL 200 IDN 200; IDN 220; IDL 200; HDN 200; HDN 220; HDN 250S; PB-D 210; PBI-D 210 RC-D 210;	KF 200; HES 200; KHFF 200 HESF 200	KG 200; KGG 200; KGHF 200; KLNC 200 KP 200; KS 200/250; KSF 200; KSH 200 KSHF 200/250; KSPS 200; KT 200 KTG 200; KTGF 200; KTH 200; KTN 200 NH 200; NHF 200; QLC 200; QLC-KS 200/250; QLC-AG 200 QLC-LS 160/200; QLK 200; QLK-KS 200/250; UVE 200/250 NHF 250/290 (INDEX)	MAC 200; MAC 220 DE 210; GA 210
IDN 250; IDN 315; IDN 400; IDL 250; IDL 315 IDL 400; HDN 250; HDN 315; HDN 400 GHDN 250; GHDN 315; GHDN 400; CD 250 CD 315; GHD-FC 250; GHD-FC 305; GHD-FC 400; HDB 300; AN-D 250 AL-D 250; AN-D 315; AL-D 315; BB-D 250; BB-D 315; BH-D 250; BH-D 315 GH-D 400; HB-D 250; HB-D 315; HDB 300 HDL 250; HDL 315; HDL 400; HDN 250 HDN 315; HDN 400; HYDN-S 250; HYDN-S 315 PB-D 250; PB-D 315; PBI-D 250; PBI-D 315 RC-D 250; RC-D 305; RC-D 400	KF 250; HES 250; KHFF 250 HESF 250; KF 315; HES 315 KHFF 315; HESF 315	KG 250/315; KL 250; KLNC 250/315 KP 250/315; KS 315/400 KSH 250/315/400 KSHK 250/315/400; KSPS 250/300 KT 250/315; KTG 250/315; KTGF 250/315 KTN 250/315; NH 250/315; NHF 250/315 QLC 250/315; QLC-KS 315/400 QLC-LS 250/315; QLC-AG 250/315 QLK 250/315; QLK-KS 315/400 UVE 315; NHF 400(INDEX)	MAC 250; MAC 315 DE 250/260/320 GA 250/315
IDN 500; IDN 630; IDN 800 IDL 500; IDL 630; IDL 800 GHDN 500; GHDN 610; GHDN 640; GHDN 800 AL-D 400; AN-D 400 GH-D 500; GH-D 610; GH-D 800 IN-D 500; IN-D 630; IN-D 800 BB-N 400; BB-N 460; BB-N 500 BH-D 400; BH-D 450; BH-D 500; BH-D 630 BH-D 800; BHD-FC 500; BHD-FC 630	KF 400; KF 500; KF630 HES 400; HES 500; HES 630 KHFF 400; KFF 400; KFF 400; KFF 500; KFF 630; HESF 400; HESF 500; HESF 630	KG 400/500; KL 400/500; KLNC 400/500 KP 400/500; KS 500/630 KSH 500; KSHF 630; KSL 630 KS-PS 400; KTG 400/500/630 KTGF 400/500/630; KTN 400/500/630 NH 400/500/630; NHF 400/500/630 QLC 400; QLK 400; UVE 400/500/630/800	DE 400

Serrated Hard Top Jaws

90° SERRATIONS - REVERSIBLE TYPE

Material:

- Steel: 590M17 or 080M15
- Black Finish

Chuck Ø 160mm - 1000mm



TYPE A

TYPE B

THAME PART No.	JAW TYPE	A	B	C	D	K	S1	S2	SERRATIONS
GR 20	B	76	44	35	14	22	24		1/16" x 90°
GY 16	A	67	44	35	17	19	10	10	1/16" x 90°
GY 20	A	74	49	40	17	19	12	12	1/16" x 90°
GY 20	A	74	49	40	17	19	12	12	1/16" x 90°
GY 25	A	104	59	50	21	25	14	14	1/16" x 90°
GY 40	A	126	75	60	25.5	31	18	18	3/32" x 90°

PRATT BURNERD	RÖHM	SCHUNK	SMW
			SP160
160 INTERNATIONAL 160 HIGH SPEED QC 165 HYD. FRONT END 210 INTERNATIONAL 210 HIGH SPEED QC 210 KB INTERNATIONAL 210 KB HIGH SPEED QC 210 CONSTANT GRIP	KFD 160; KFD-AF 160; KFD-HF 160; KFD-HS 200; KFH 160; KFH-F 160; KFH-G 160; KFH-HC 160 SPD 160; SPO 160	HSL 165 ROTA NC 165 ROTA NCD 185 ROTA NCF 165 TH 165 THF 165	HKKS 160/200 KDV 160/200/250 KDBG 160/200/250 KDM 160/200 KDM-F 160/200/250 KMA 160/200/250 KMAF 160/200/250 KFV160/200 SP 200 KFMF 160/200 HFK 160/200
200 INTERNATIONAL 200 HIGH SPEED QC 210 HYD. FRONT END 250 HIGH SPEED QC 254 INTERNATIONAL 265 HIGH SPEED QC 265 KB INTERNATIONAL 265 KB HIGH SPEED QC 254 CONSTANT GRIP	KFD 200; KFD-AF 200; KFD-HE 200; KFD-HF 200 KFD-HS 250; KFH 200; KFH-F 200 KFH-G 200; KFH-NC 200 KFL 250; LVE 200; SPD 215; SPO 215	HSL 210 ROTA NC 210; ROTA NCD 210 ROTA NCF 210; ROTA NCO 210; ROTA TP 200; TH 210; THF 210 TP 200; ROTA NCK 210/250 ROTA NC plus 215; ROTA NCF plus 215	HFKS 200 KDV 200/250 KDBG 200/250 KDM 200 KDM-F 200/250 KMA 200/250 KMA-F 200/250 KFV 200 KFMF 200 HFK 200
250 INTERNATIONAL 254 HYD. FRONT END 305 HYD. FRONT END 305 INTERNATIONAL 305 HIGH SPEED QC 315 INTERNATIONAL 400 HIGH SPEED QC 305 KB INTERNATIONAL 305 KB HIGH SPEED QC 305 CONSTANT GRIP	KFD 250/315; KFD-AF 250/315 KFD-HE 254/315 KFD-HF 250/315 KFD-HS 315 KFH 250/315; KFH-F 250/315 KFH-G 250/315 KFH-NC 250/315 KFL 250/315 LVE 250/305/315 SPD 300; SPO 300	HSL 250; HSL 315; ROTA NC 250/315 ROTA NC plus 260/315; ROTA NCD 250; ROTA NCD 315 ROTA NCF 250; ROTA NCF 315 ROTA NCF plus 260/315 ROTA NCK plus 315 ROTA NCO 260/315 ROTA TP 250; ROTA TP 315 TH 250/315; THF 250/315	HFK 250/315 HFKS 250/315 KDV 315/400 KDBG 315/400 KDM 250/315/400 KDM-F 315/400 KMA 315/400 KMA-F 315
400 INTERNATIONAL 400 HYD. FRONT END 500 HYD. FRONT END	KFD 400/500/630/800 KFD-HE 400 KFD-HF 400/500/630 KFD-HS 400/500 KFH 400/500; KFH-F 400/500 KFH-G 400/500 KFH-NC 400/500 KFL 500/600 LVE 400/500/630/800/1000	HSG 400-500; HSL 400; ROTA NC 400 ROTA NC 500; ROTA NCD 400/500 ROTA NCF 400/500 ROTA NCO 400/500 TH 400; TH 500 THF 400; THF 500	HFK 400/500 HFKS 400/500 KDV 500 KDBG 500 KDM 500 KFV 400/500/630/800