

SLOT DRILLS & END MILLS

2 Flute Miniature Slot Drills

Supplied by Magafor

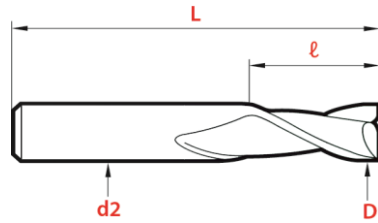
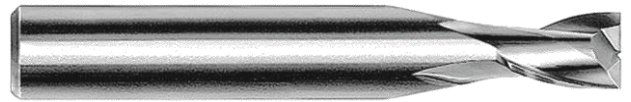

Code 8500 Carbide K15

Range D	Tolerance			
	D	L	ℓ	d2
0.05-0.08	±0.005	+0.03	-1	h6
0.10-0.12	±0.005	+0.08	-1	h6
0.15-0.25	h7	+0.10	-1	h6
0.30-0.45	h7	+0.15	-1	h6
0.50-0.65	h7	+0.20	-1	h6
0.70-2.00	h7	+0.30	-1	h6
2.10-14.00	h7	+0.50	-1	h6

Product Code	Price	Description	D	L	ℓ	d2
D0005DAM	£134.30	0.05mm 2-Flute Carbide Miniature Slot Drill	0.05	39	0.1	3
D0006DAM	£115.45	0.06mm 2-Flute Carbide Miniature Slot Drill	0.06	39	0.12	3
D0008DAM	£97.85	0.08mm 2-Flute Carbide Miniature Slot Drill	0.08	39	0.16	3
D0010DAM	£81.40	0.1mm 2-Flute Carbide Miniature Slot Drill	0.10	39	0.2	3
D0012DAM	£81.40	0.12mm 2-Flute Carbide Miniature Slot Drill	0.12	39	0.24	3
D0015DAM	£69.65	0.15mm 2-Flute Carbide Miniature Slot Drill	0.15	39	0.3	3
D0020DAM	£57.85	0.2mm 2-Flute Carbide Miniature Slot Drill	0.20	39	0.5	3
D0025DAM	£57.85	0.25mm 2-Flute Carbide Miniature Slot Drill	0.25	39	0.5	3
D0030DAM	£39.65	0.3mm 2-Flute Carbide Miniature Slot Drill	0.30	39	0.8	3
D0035DAM	£39.65	0.35mm 2-Flute Carbide Miniature Slot Drill	0.35	39	0.8	3
D0040DAM	£39.65	0.4mm 2-Flute Carbide Miniature Slot Drill	0.40	39	1	3
D0045DAM	£39.65	0.45mm 2-Flute Carbide Miniature Slot Drill	0.45	39	1	3
D0050DAM	£30.85	0.5mm 2-Flute Carbide Miniature Slot Drill	0.50	39	1.5	3
D0055DAM	£30.85	0.55mm 2-Flute Carbide Miniature Slot Drill	0.55	39	1.5	3
D0060DAM	£30.85	0.6mm 2-Flute Carbide Miniature Slot Drill	0.60	39	1.5	3
D0065DAM	£30.85	0.65mm 2-Flute Carbide Miniature Slot Drill	0.65	39	1.5	3
D0070DAM	£30.85	0.7mm 2-Flute Carbide Miniature Slot Drill	0.70	39	2	3
D0075DAM	£30.85	0.75mm 2-Flute Carbide Miniature Slot Drill	0.75	39	2	3
D0080DAM	£30.85	0.8mm 2-Flute Carbide Miniature Slot Drill	0.80	39	2	3
D0085DAM	£30.85	0.85mm 2-Flute Carbide Miniature Slot Drill	0.85	39	2	3
D0090DAM	£30.85	0.9mm 2-Flute Carbide Miniature Slot Drill	0.90	39	2.5	3
D0095DAM	£30.85	0.95mm 2-Flute Carbide Miniature Slot Drill	0.95	39	2.5	3
D0100DAM	£28.55	1mm 2-Flute Carbide Miniature Slot Drill	1.00	39	3	3
D0105DAM	£33.25	1.05mm 2-Flute Carbide Miniature Slot Drill	1.05	39	3	3
D0110DAM	£33.25	1.1mm 2-Flute Carbide Miniature Slot Drill	1.10	39	3	3
D0115DAM	£33.25	1.15mm 2-Flute Carbide Miniature Slot Drill	1.15	39	3	3
D0120DAM	£33.25	1.2mm 2-Flute Carbide Miniature Slot Drill	1.20	39	4	3
D0125DAM	£33.25	1.25mm 2-Flute Carbide Miniature Slot Drill	1.25	39	4	3
D0130DAM	£33.25	1.3mm 2-Flute Carbide Miniature Slot Drill	1.30	39	4	3
D0140DAM	£33.25	1.4mm 2-Flute Carbide Miniature Slot Drill	1.40	39	4	3
D0145DAM	£33.25	1.45mm 2-Flute Carbide Miniature Slot Drill	1.45	39	4	3
D0150DAM	£28.55	1.5mm 2-Flute Carbide Miniature Slot Drill	1.50	39	4	3
D0155DAM	£33.25	1.55mm 2-Flute Carbide Miniature Slot Drill	1.55	39	5	3
D0160DAM	£33.25	1.6mm 2-Flute Carbide Miniature Slot Drill	1.60	39	5	3
D0170DAM	£33.25	1.7mm 2-Flute Carbide Miniature Slot Drill	1.70	39	5	3
D0175DAM	£33.25	1.75mm 2-Flute Carbide Miniature Slot Drill	1.75	39	5	3
D0180DAM	£33.25	1.8mm 2-Flute Carbide Miniature Slot Drill	1.80	39	5	3
D0190DAM	£33.25	1.9mm 2-Flute Carbide Miniature Slot Drill	1.90	39	5	3
D0200DAM	£30.85	2mm 2-Flute Carbide Miniature Slot Drill	2.00	39	5	3
D0205DAM	£42.65	2.05mm 2-Flute Carbide Miniature Slot Drill	2.05	39	6	3
D0210DAM	£42.65	2.1mm 2-Flute Carbide Miniature Slot Drill	2.10	39	6	3
D0220DAM	£42.65	2.2mm 2-Flute Carbide Miniature Slot Drill	2.20	39	6	3
D0225DAM	£42.65	2.25mm 2-Flute Carbide Miniature Slot Drill	2.25	39	6	3
D0230DAM	£42.65	2.3mm 2-Flute Carbide Miniature Slot Drill	2.30	39	6	3

(Prices do not include VAT)

SLOT DRILLS & END MILLS

2 Flute Miniature Slot Drills

Supplied by Magafor

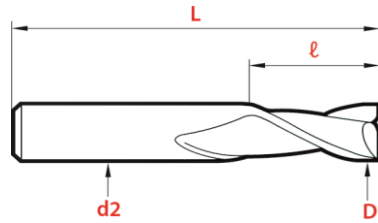
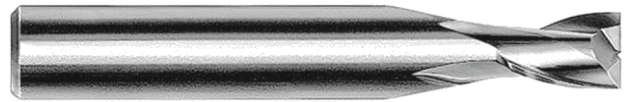

Code 8500 Carbide K15

Range D	Tolerance			
	D	L	ℓ	d2
0.05-0.08	±0.005	+0.03	-1	h6
0.10-0.12	±0.005	+0.08	-1	h6
0.15-0.25	h7	+0.10	-1	h6
0.30-0.45	h7	+0.15	-1	h6
0.50-0.65	h7	+0.20	-1	h6
0.70-2.00	h7	+0.30	-1	h6
2.10-14.00	h7	+0.50	-1	h6

Product Code	Price	Description	D	L	ℓ	d2
D0240DAM	£42.65	2.4mm 2-Flute Carbide Miniature Slot Drill	2.40	39	6	3
D0250DAM	£37.95	2.5mm 2-Flute Carbide Miniature Slot Drill	2.50	39	7	3
D0260DAM	£46.15	2.6mm 2-Flute Carbide Miniature Slot Drill	2.60	39	7	3
D0270DAM	£46.15	2.7mm 2-Flute Carbide Miniature Slot Drill	2.70	39	7	3
D0275DAM	£46.15	2.75mm 2-Flute Carbide Miniature Slot Drill	2.75	39	7	3
D0280DAM	£46.15	2.8mm 2-Flute Carbide Miniature Slot Drill	2.80	39	7	3
D0290DAM	£46.15	2.9mm 2-Flute Carbide Miniature Slot Drill	2.90	39	7	3
D0300DAM	£42.65	3mm 2-Flute Carbide Miniature Slot Drill	3.00	44	10	4
D0305DAM	£49.70	3.05mm 2-Flute Carbide Miniature Slot Drill	3.05	44	10	4
D0310DAM	£49.70	3.1mm 2-Flute Carbide Miniature Slot Drill	3.10	44	10	4
D0317DAM	£49.70	3.17mm 2-Flute Carbide Miniature Slot Drill	3.17	44	10	4
D0320DAM	£49.70	3.2mm 2-Flute Carbide Miniature Slot Drill	3.20	44	10	4
D0325DAM	£49.70	3.25mm 2-Flute Carbide Miniature Slot Drill	3.25	44	10	4
D0330DAM	£49.70	3.3mm 2-Flute Carbide Miniature Slot Drill	3.30	44	10	4
D0340DAM	£49.70	3.4mm 2-Flute Carbide Miniature Slot Drill	3.40	44	10	4
D0350DAM	£49.70	3.5mm 2-Flute Carbide Miniature Slot Drill	3.50	44	10	4
D0360DAM	£49.70	3.6mm 2-Flute Carbide Miniature Slot Drill	3.60	44	10	4
D0370DAM	£49.70	3.7mm 2-Flute Carbide Miniature Slot Drill	3.70	44	10	4
D0380DAM	£49.70	3.8mm 2-Flute Carbide Miniature Slot Drill	3.80	44	10	4
D0390DAM	£49.70	3.9mm 2-Flute Carbide Miniature Slot Drill	3.90	44	10	4
D0400DAM	£46.15	4mm 2-Flute Carbide Miniature Slot Drill	4.00	52	12	5
D0405DAM	£52.05	4.05mm 2-Flute Carbide Miniature Slot Drill	4.05	52	12	5
D0410DAM	£52.05	4.1mm 2-Flute Carbide Miniature Slot Drill	4.10	52	12	5
D0420DAM	£52.05	4.2mm 2-Flute Carbide Miniature Slot Drill	4.20	52	12	5
D0430DAM	£52.05	4.3mm 2-Flute Carbide Miniature Slot Drill	4.30	52	12	5
D0440DAM	£52.05	4.4mm 2-Flute Carbide Miniature Slot Drill	4.40	52	12	5
D0450DAM	£52.05	4.5mm 2-Flute Carbide Miniature Slot Drill	4.50	52	12	5
D0460DAM	£52.05	4.6mm 2-Flute Carbide Miniature Slot Drill	4.60	52	12	5
D0470DAM	£52.05	4.7mm 2-Flute Carbide Miniature Slot Drill	4.70	52	12	5
D0476DAM	£52.05	4.76mm 2-Flute Carbide Miniature Slot Drill	4.76	52	12	5
D0480DAM	£52.05	4.8mm 2-Flute Carbide Miniature Slot Drill	4.80	52	12	5
D0490DAM	£52.05	4.9mm 2-Flute Carbide Miniature Slot Drill	4.90	52	12	5
D0500DAM	£49.70	5mm 2-Flute Carbide Miniature Slot Drill	5.00	52	14	6
D0505DAM	£54.35	5.05mm 2-Flute Carbide Miniature Slot Drill	5.05	52	14	6
D0510DAM	£54.35	5.1mm 2-Flute Carbide Miniature Slot Drill	5.10	52	14	6
D0520DAM	£54.35	5.2mm 2-Flute Carbide Miniature Slot Drill	5.20	52	14	6
D0530DAM	£54.35	5.3mm 2-Flute Carbide Miniature Slot Drill	5.30	52	14	6
D0540DAM	£54.35	5.4mm 2-Flute Carbide Miniature Slot Drill	5.40	52	14	6
D0550DAM	£54.35	5.5mm 2-Flute Carbide Miniature Slot Drill	5.50	52	14	6
D0560DAM	£54.35	5.6mm 2-Flute Carbide Miniature Slot Drill	5.60	52	14	6
D0570DAM	£54.35	5.7mm 2-Flute Carbide Miniature Slot Drill	5.70	52	14	6
D0580DAM	£54.35	5.8mm 2-Flute Carbide Miniature Slot Drill	5.80	52	14	6
D0590DAM	£54.35	5.9mm 2-Flute Carbide Miniature Slot Drill	5.90	52	14	6
D0600DAM	£51.40	6mm 2-Flute Carbide Miniature Slot Drill	6.00	52	16	6

(Prices do not include VAT)

SLOT DRILLS & END MILLS

2 Flute Miniature Slot Drills

Supplied by Magafor

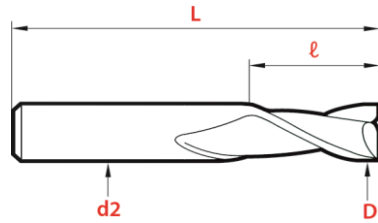
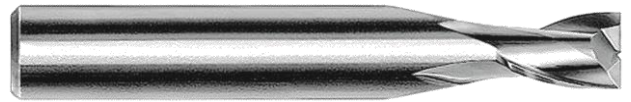

Code 8500 Carbide K15

Range D	Tolerance			
	D	L	ℓ	d2
0.05-0.08	±0.005	+0.03	-1	h6
0.10-0.12	±0.005	+0.08	-1	h6
0.15-0.25	h7	+0.10	-1	h6
0.30-0.45	h7	+0.15	-1	h6
0.50-0.65	h7	+0.20	-1	h6
0.70-2.00	h7	+0.30	-1	h6
2.10-14.00	h7	+0.50	-1	h6

Product Code	Price	Description	D	L	ℓ	d2
D0605DAM	£73.30	6.05mm 2-Flute Carbide Miniature Slot Drill	6.05	63	18	8
D0610DAM	£73.30	6.1mm 2-Flute Carbide Miniature Slot Drill	6.10	63	18	8
D0620DAM	£73.30	6.2mm 2-Flute Carbide Miniature Slot Drill	6.20	63	18	8
D0630DAM	£73.30	6.3mm 2-Flute Carbide Miniature Slot Drill	6.30	63	18	8
D0635DAM	£73.30	6.35mm 2-Flute Carbide Miniature Slot Drill	6.35	63	18	8
D0640DAM	£73.30	6.4mm 2-Flute Carbide Miniature Slot Drill	6.40	63	18	8
D0650DAM	£73.30	6.5mm 2-Flute Carbide Miniature Slot Drill	6.50	63	18	8
D0660DAM	£73.30	6.6mm 2-Flute Carbide Miniature Slot Drill	6.60	63	18	8
D0670DAM	£73.30	6.7mm 2-Flute Carbide Miniature Slot Drill	6.70	63	18	8
D0680DAM	£73.30	6.8mm 2-Flute Carbide Miniature Slot Drill	6.80	63	18	8
D0690DAM	£73.30	6.9mm 2-Flute Carbide Miniature Slot Drill	6.90	63	18	8
D0700DAM	£73.30	7mm 2-Flute Carbide Miniature Slot Drill	7.00	63	18	8
D0710DAM	£73.30	7.1mm 2-Flute Carbide Miniature Slot Drill	7.10	63	20	8
D0720DAM	£73.30	7.2mm 2-Flute Carbide Miniature Slot Drill	7.20	63	20	8
D0730DAM	£73.30	7.3mm 2-Flute Carbide Miniature Slot Drill	7.30	63	20	8
D0740DAM	£73.30	7.4mm 2-Flute Carbide Miniature Slot Drill	7.40	63	20	8
D0750DAM	£73.30	7.5mm 2-Flute Carbide Miniature Slot Drill	7.50	63	20	8
D0760DAM	£73.30	7.6mm 2-Flute Carbide Miniature Slot Drill	7.60	63	20	8
D0770DAM	£73.30	7.7mm 2-Flute Carbide Miniature Slot Drill	7.70	63	20	8
D0780DAM	£73.30	7.8mm 2-Flute Carbide Miniature Slot Drill	7.80	63	20	8
D0790DAM	£73.30	7.9mm 2-Flute Carbide Miniature Slot Drill	7.90	63	20	8
D0794DAM	£73.30	7.94mm 2-Flute Carbide Miniature Slot Drill	7.94	63	20	8
D0800DAM	£60.85	8mm 2-Flute Carbide Miniature Slot Drill	8.00	63	20	8
D0810DAM	£89.65	8.1mm 2-Flute Carbide Miniature Slot Drill	8.10	72	20	10
D0820DAM	£89.65	8.2mm 2-Flute Carbide Miniature Slot Drill	8.20	72	20	10
D0830DAM	£89.65	8.3mm 2-Flute Carbide Miniature Slot Drill	8.30	72	20	10
D0840DAM	£89.65	8.4mm 2-Flute Carbide Miniature Slot Drill	8.40	72	20	10
D0850DAM	£96.80	8.5mm 2-Flute Carbide Miniature Slot Drill	8.50	72	20	10
D0860DAM	£96.80	8.6mm 2-Flute Carbide Miniature Slot Drill	8.60	72	20	10
D0870DAM	£96.80	8.7mm 2-Flute Carbide Miniature Slot Drill	8.70	72	20	10
D0880DAM	£96.80	8.8mm 2-Flute Carbide Miniature Slot Drill	8.80	72	20	10
D0890DAM	£96.80	8.9mm 2-Flute Carbide Miniature Slot Drill	8.90	72	20	10
D0900DAM	£96.80	9mm 2-Flute Carbide Miniature Slot Drill	9.00	72	22	10
D0910DAM	£96.80	9.1mm 2-Flute Carbide Miniature Slot Drill	9.10	72	22	10
D0920DAM	£96.80	9.2mm 2-Flute Carbide Miniature Slot Drill	9.20	72	22	10
D0930DAM	£96.80	9.3mm 2-Flute Carbide Miniature Slot Drill	9.30	72	22	10
D0940DAM	£96.80	9.4mm 2-Flute Carbide Miniature Slot Drill	9.40	72	22	10
D0950DAM	£96.80	9.5mm 2-Flute Carbide Miniature Slot Drill	9.50	72	22	10
D0952DAM	£96.80	9.52mm 2-Flute Carbide Miniature Slot Drill	9.52	72	22	10
D0960DAM	£96.80	9.6mm 2-Flute Carbide Miniature Slot Drill	9.60	72	22	10
D0970DAM	£96.80	9.7mm 2-Flute Carbide Miniature Slot Drill	9.70	72	22	10
D0980DAM	£96.80	9.8mm 2-Flute Carbide Miniature Slot Drill	9.80	72	22	10
D0990DAM	£89.65	9.9mm 2-Flute Carbide Miniature Slot Drill	9.90	72	22	10
D1000DAM	£89.15	10mm 2-Flute Carbide Miniature Slot Drill	10.00	72	20	10

(Prices do not include VAT)

SLOT DRILLS & END MILLS

2 Flute Miniature Slot Drills

Supplied by Magafor

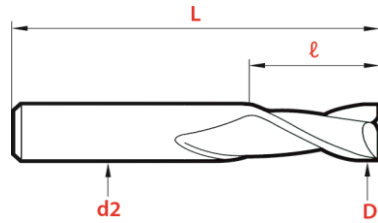
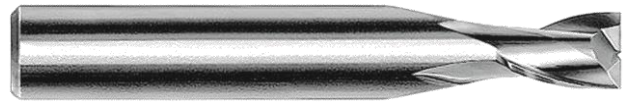

Code 8500 Carbide K15

Range D	Tolerance			
	D	L	ℓ	d2
0.05-0.08	±0.005	+0.03	-1	h6
0.10-0.12	±0.005	+0.08	-1	h6
0.15-0.25	h7	+0.10	-1	h6
0.30-0.45	h7	+0.15	-1	h6
0.50-0.65	h7	+0.20	-1	h6
0.70-2.00	h7	+0.30	-1	h6
2.10-14.00	h7	+0.50	-1	h6

Product Code	Price	Description	D	L	ℓ	d2
D1010DAM	£141.20	10.1mm 2-Flute Carbide Miniature Slot Drill	10.10	83	26	12
D1020DAM	£141.20	10.2mm 2-Flute Carbide Miniature Slot Drill	10.20	83	26	12
D1030DAM	£141.20	10.3mm 2-Flute Carbide Miniature Slot Drill	10.30	83	26	12
D1040DAM	£141.20	10.4mm 2-Flute Carbide Miniature Slot Drill	10.40	83	26	12
D1050DAM	£141.20	10.5mm 2-Flute Carbide Miniature Slot Drill	10.50	83	26	12
D1060DAM	£141.20	10.6mm 2-Flute Carbide Miniature Slot Drill	10.60	83	26	12
D1070DAM	£141.20	10.7mm 2-Flute Carbide Miniature Slot Drill	10.70	83	26	12
D1080DAM	£141.20	10.8mm 2-Flute Carbide Miniature Slot Drill	10.80	83	26	12
D1090DAM	£141.20	10.9mm 2-Flute Carbide Miniature Slot Drill	10.90	83	26	12
D1100DAM	£141.20	11mm 2-Flute Carbide Miniature Slot Drill	11.00	83	28	12
D1110DAM	£141.20	11.1mm 2-Flute Carbide Miniature Slot Drill	11.10	83	28	12
D1120DAM	£141.20	11.2mm 2-Flute Carbide Miniature Slot Drill	11.20	83	28	12
D1130DAM	£141.20	11.3mm 2-Flute Carbide Miniature Slot Drill	11.30	83	28	12
D1140DAM	£141.20	11.4mm 2-Flute Carbide Miniature Slot Drill	11.40	83	28	12
D1150DAM	£141.20	11.5mm 2-Flute Carbide Miniature Slot Drill	11.50	83	28	12
D1160DAM	£141.20	11.6mm 2-Flute Carbide Miniature Slot Drill	11.60	83	28	12
D1170DAM	£141.20	11.7mm 2-Flute Carbide Miniature Slot Drill	11.70	83	28	12
D1180DAM	£141.20	11.8mm 2-Flute Carbide Miniature Slot Drill	11.80	83	28	12
D1190DAM	£141.20	11.9mm 2-Flute Carbide Miniature Slot Drill	11.90	83	28	12
D1200DAM	£131.90	12mm 2-Flute Carbide Miniature Slot Drill	12.00	83	30	12
D1210DAM	£213.60	12.1mm 2-Flute Carbide Miniature Slot Drill	12.10	83	30	14
D1220DAM	£213.60	12.2mm 2-Flute Carbide Miniature Slot Drill	12.20	83	30	14
D1230DAM	£213.60	12.3mm 2-Flute Carbide Miniature Slot Drill	12.30	83	30	14
D1240DAM	£213.60	12.4mm 2-Flute Carbide Miniature Slot Drill	12.40	83	30	14
D1250DAM	£213.60	12.5mm 2-Flute Carbide Miniature Slot Drill	12.50	83	30	14
D1260DAM	£213.60	12.6mm 2-Flute Carbide Miniature Slot Drill	12.60	83	30	14
D1270DAM	£213.60	12.7mm 2-Flute Carbide Miniature Slot Drill	12.70	83	30	14
D1280DAM	£213.60	12.8mm 2-Flute Carbide Miniature Slot Drill	12.80	83	30	14
D1290DAM	£213.60	12.9mm 2-Flute Carbide Miniature Slot Drill	12.90	83	30	14
D1300DAM	£213.60	13mm 2-Flute Carbide Miniature Slot Drill	13.00	83	32	14
D1310DAM	£213.60	13.1mm 2-Flute Carbide Miniature Slot Drill	13.10	83	32	14
D1320DAM	£213.60	13.2mm 2-Flute Carbide Miniature Slot Drill	13.20	83	32	14
D1330DAM	£213.60	13.3mm 2-Flute Carbide Miniature Slot Drill	13.30	83	32	14
D1340DAM	£213.60	13.4mm 2-Flute Carbide Miniature Slot Drill	13.40	83	32	14
D1350DAM	£213.60	13.5mm 2-Flute Carbide Miniature Slot Drill	13.50	83	32	14
D1360DAM	£213.60	13.6mm 2-Flute Carbide Miniature Slot Drill	13.60	83	32	14
D1370DAM	£213.60	13.7mm 2-Flute Carbide Miniature Slot Drill	13.70	83	32	14
D1380DAM	£213.60	13.8mm 2-Flute Carbide Miniature Slot Drill	13.80	83	32	14
D1390DAM	£213.60	13.9mm 2-Flute Carbide Miniature Slot Drill	13.90	83	32	14
D1400DAM	£213.60	14mm 2-Flute Carbide Miniature Slot Drill	14.00	83	32	14

(Prices do not include VAT)

SLOT DRILLS & END MILLS

2 Flute Carbide Stub Miniature Slot Drills

Supplied by Magafor

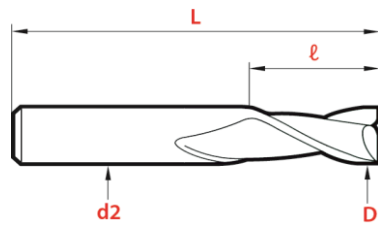
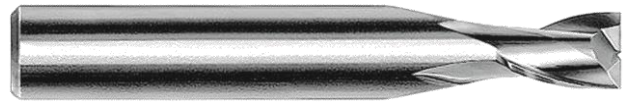

Code 8507 Carbide K15 Micrograin

Range D	Tolerance			
	D	L	ℓ	d2
0.10-0.12	±0.005	+0.08	-1	h6
0.15-0.25	h7	+0.10	-1	h6
0.30-0.45	h7	+0.15	-1	h6
0.50-0.65	h7	+0.20	-1	h6
0.70-2.00	h7	+0.30	-1	h6

Product Code	Price	Description	D	L	ℓ	d2
D0010DFM	£70.60	0.1mm 2-Flute Carbide Stub Miniature Slot Drill	0.10	39	0.10	3
D0015DFM	£60.35	0.15mm 2-Flute Carbide Stub Miniature Slot Drill	0.15	39	0.20	3
D0020DFM	£50.15	0.2mm 2-Flute Carbide Stub Miniature Slot Drill	0.20	39	0.30	3
D0025DFM	£50.15	0.25mm 2-Flute Carbide Stub Miniature Slot Drill	0.25	39	0.35	3
D0030DFM	£32.25	0.3mm 2-Flute Carbide Stub Miniature Slot Drill	0.30	39	0.45	3
D0040DFM	£32.25	0.4mm 2-Flute Carbide Stub Miniature Slot Drill	0.40	39	0.60	3
D0050DFM	£25.85	0.5mm 2-Flute Carbide Stub Miniature Slot Drill	0.50	39	0.75	3
D0060DFM	£25.85	0.6mm 2-Flute Carbide Stub Miniature Slot Drill	0.60	39	0.90	3
D0070DFM	£25.85	0.7mm 2-Flute Carbide Stub Miniature Slot Drill	0.70	39	1.05	3
D0080DFM	£25.85	0.8mm 2-Flute Carbide Stub Miniature Slot Drill	0.80	39	1.20	3
D0090DFM	£25.85	0.9mm 2-Flute Carbide Stub Miniature Slot Drill	0.90	39	1.35	3
D0100DFM	£25.85	1mm 2-Flute Carbide Stub Miniature Slot Drill	1.00	39	1.50	3
D0110DFM	£25.85	1.1mm 2-Flute Carbide Stub Miniature Slot Drill	1.10	39	1.65	3
D0120DFM	£25.85	1.2mm 2-Flute Carbide Stub Miniature Slot Drill	1.20	39	1.80	3
D0130DFM	£25.85	1.3mm 2-Flute Carbide Stub Miniature Slot Drill	1.30	39	1.95	3
D0140DFM	£25.85	1.4mm 2-Flute Carbide Stub Miniature Slot Drill	1.40	39	2.10	3
D0150DFM	£25.85	1.5mm 2-Flute Carbide Stub Miniature Slot Drill	1.50	39	2.25	3
D0160DFM	£25.85	1.6mm 2-Flute Carbide Stub Miniature Slot Drill	1.60	39	2.40	3
D0170DFM	£25.85	1.7mm 2-Flute Carbide Stub Miniature Slot Drill	1.70	39	2.55	3
D0180DFM	£25.85	1.8mm 2-Flute Carbide Stub Miniature Slot Drill	1.80	39	2.70	3
D0190DFM	£25.85	1.9mm 2-Flute Carbide Stub Miniature Slot Drill	1.90	39	2.85	3
D0200DFM	£25.85	2mm 2-Flute Carbide Stub Miniature Slot Drill	2.00	39	3.00	3

(Prices do not include VAT)

SLOT DRILLS & END MILLS

2 Flute Carbide Long Miniature Slot Drills

Supplied by Magafor

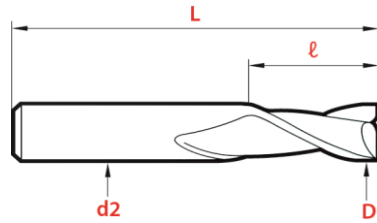
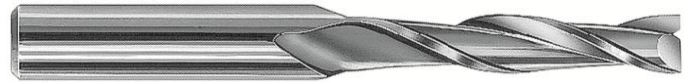

Code 8509 Carbide K15 Micrograin

Range D	Tolerance			
	D	L	ℓ	d2
0.10-0.12	±0.005	+0.08	-1	h6
0.15-0.25	h7	+0.10	-1	h6
0.30-0.45	h7	+0.15	-1	h6
0.50-0.65	h7	+0.20	-1	h6
0.70-2.00	h7	+0.30	-1	h6
2.10-3.00	h7	+0.50	-1	h6

Product Code	Price	Description	D	L	ℓ	d2
D0030DEM	£62.85	0.3mm 2-Flute Carbide Long Miniature Slot Drill	0.3	39	0.5	3
D0040DEM	£59.05	0.4mm 2-Flute Carbide Long Miniature Slot Drill	0.4	39	2.0	3
D0050DEM	£52.70	0.5mm 2-Flute Carbide Long Miniature Slot Drill	0.5	39	2.5	3
D0060DEM	£51.40	0.6mm 2-Flute Carbide Long Miniature Slot Drill	0.6	39	3.0	3
D0070DEM	£50.15	0.7mm 2-Flute Carbide Long Miniature Slot Drill	0.7	39	3.5	3
D0080DEM	£48.85	0.8mm 2-Flute Carbide Long Miniature Slot Drill	0.8	39	4.0	3
D0090DEM	£48.85	0.9mm 2-Flute Carbide Long Miniature Slot Drill	0.9	39	4.5	3
D0100DEM	£48.85	1mm 2-Flute Carbide Long Miniature Slot Drill	1.0	39	5.0	3
D0120DEM	£48.85	1.2mm 2-Flute Carbide Long Miniature Slot Drill	1.2	39	6.0	3
D0150DEM	£48.85	1.5mm 2-Flute Carbide Long Miniature Slot Drill	1.5	39	7.5	3
D0200DEM	£48.85	2mm 2-Flute Carbide Long Miniature Slot Drill	2.0	39	10.0	3
D0250DEM	£48.85	2.5mm 2-Flute Carbide Long Miniature Slot Drill	2.5	45	12.5	3
D0300DEM	£48.85	3mm 2-Flute Carbide Long Miniature Slot Drill	3.0	46	15.0	4

(Prices do not include VAT)

SLOT DRILLS & END MILLS

2 Flute Carbide Extra Long Miniature Slot Drills

Supplied by Magafor

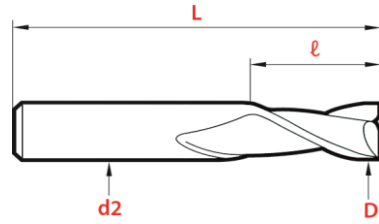

Code 8510 Carbide K15 Micrograin

Range D	Tolerance			d2
	D	L	ℓ	
0.30-0.45	h7	+0.15	-1	h6
0.50-0.65	h7	+0.20	-1	h6
0.70-2.00	h7	+0.30	-1	h6
2.10-6.00	h7	+0.50	-1	h6

Product Code	Price	Description	D	L	ℓ	d2
D0030DBM	£84.65	0.3mm 2-Flute Carbide Extra Long Miniature Slot Drill	0.3	39	2.4	3
D0040DBM	£78.20	0.4mm 2-Flute Carbide Extra Long Miniature Slot Drill	0.4	39	3.2	3
D0050DBM	£70.60	0.5mm 2-Flute Carbide Extra Long Miniature Slot Drill	0.5	39	4.0	3
D0060DBM	£70.60	0.6mm 2-Flute Carbide Extra Long Miniature Slot Drill	0.6	39	5.0	3
D0080DBM	£70.60	0.8mm 2-Flute Carbide Extra Long Miniature Slot Drill	0.8	39	6.0	3
D0100DBM	£70.60	1mm 2-Flute Carbide Extra Long Miniature Slot Drill	1.0	39	8.0	3
D0120DBM	£85.90	1.2mm 2-Flute Carbide Extra Long Miniature Slot Drill	1.2	39	9.0	3
D0150DBM	£85.90	1.5mm 2-Flute Carbide Extra Long Miniature Slot Drill	1.5	44	12.0	4
D0160DBM	£89.70	1.6mm 2-Flute Carbide Extra Long Miniature Slot Drill	1.6	44	12.8	4
D0200DBM	£89.70	2mm 2-Flute Carbide Extra Long Miniature Slot Drill	2.0	44	16.0	4
D0250DBM	£107.65	2.5mm 2-Flute Carbide Extra Long Miniature Slot Drill	2.5	60	20.0	5
D0300DBM	£110.15	3mm 2-Flute Carbide Extra Long Miniature Slot Drill	3.0	60	24.0	5
D0400DBM	£112.70	4mm 2-Flute Carbide Extra Long Miniature Slot Drill	4.0	75	32.0	6
D0500DBM	£114.00	5mm 2-Flute Carbide Extra Long Miniature Slot Drill	5.0	75	40.0	6
D0600DBM	£121.00	6mm 2-Flute Carbide Extra Long Miniature Slot Drill	6.0	80	48.0	8

(Prices do not include VAT)

SLOT DRILLS & END MILLS

Carbide Miniature Ball End Mills

Supplied by Magafor

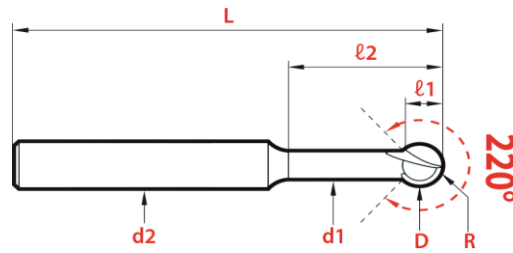

Code 8522H Carbide K15
220° Miniature Ball End Mills

Range D	Tolerance			
	D	Ø1	L	d2
0.8-2.0	±0.02	+0.3	-1	h6
0.3-5.0	±0.02	+0.5	-1	h6

Product Code	Price	Description	D	d1	d2	L	Ø1	Ø2	R
D0080DVB	£96.70	0.8mm Carbide Miniature Ball End Mill	0.8	0.70	3	60	0.55	4	0.4
D0100DVB	£90.80	1mm Carbide Miniature Ball End Mill	1.0	0.85	3	60	0.70	5	0.5
D0120DVB	£96.70	1.2mm Carbide Miniature Ball End Mill	1.2	1.00	3	60	0.80	6	0.6
D0150DVB	£97.85	1.5mm Carbide Miniature Ball End Mill	1.5	1.30	3	60	1.00	7.5	0.8
D0200DVB	£101.35	2mm Carbide Miniature Ball End Mill	2.0	1.70	3	60	1.35	10	1.0
D0300DVB	£113.15	3mm Carbide Miniature Ball End Mill	3.0	2.60	6	75	2.00	15	1.5
D0400DVB	£123.70	4mm Carbide Miniature Ball End Mill	4.0	3.45	6	75	2.70	20	2.0
D0500DVB	£134.30	5mm Carbide Miniature Ball End Mill	5.0	4.30	6	75	3.40	25	2.5

(Prices do not include VAT)

SLOT DRILLS & END MILLS

2 Flute Carbide Slot Drills with Back Clearance

Supplied by Magafor



Code 8507-D Carbide K15 Micrograin
Also available in Graph X and Hard X

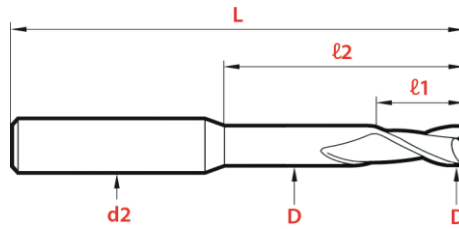

Range D	Tolerance			
	D	L	ℓ	d2
0.4	-0.01	+0.15	-1	h6
0.5-0.6	-0.01	+0.20	-1	h6
0.7-2.0	-0.01	+0.30	-1	h6
2.5	-0.01	+0.50	-1	h6

Product Code	Price	Description	D	ℓ2	L	ℓ1	d2
D004002DAL	£52.70	0.4mm x 2mm 2-Flute Carbide Slot Drill with Back Clearance	0.4	2.0	39	0.60	3
D005002DAL	£52.70	0.5mm x 2mm 2-Flute Carbide Slot Drill with Back Clearance	0.5	2.0	39	0.75	3
D005004DAL	£52.70	0.5mm x 4mm 2-Flute Carbide Slot Drill with Back Clearance	0.5	4.0	39	0.75	3
D005006DAL	£80.80	0.5mm x 6mm 2-Flute Carbide Slot Drill with Back Clearance	0.5	6.0	60	0.75	3
D006004DAL	£52.70	0.6mm x 4mm 2-Flute Carbide Slot Drill with Back Clearance	0.6	4.0	39	0.90	3
D007004DAL	£52.70	0.7mm x 4mm 2-Flute Carbide Slot Drill with Back Clearance	0.7	4.0	39	1.05	3
D008004DAL	£52.70	0.8mm x 4mm 2-Flute Carbide Slot Drill with Back Clearance	0.8	4.0	39	1.20	3
D008006DAL	£66.75	0.8mm x 6mm 2-Flute Carbide Slot Drill with Back Clearance	0.8	6.0	39	1.20	3
D008009DAL	£80.80	0.8mm x 9mm 2-Flute Carbide Slot Drill with Back Clearance	0.8	9.0	60	1.20	3
D009006DAL	£66.75	0.9mm x 6mm 2-Flute Carbide Slot Drill with Back Clearance	0.9	6.0	39	1.35	3
D010004DAL	£52.70	1mm x 4mm 2-Flute Carbide Slot Drill with Back Clearance	1.0	4.0	39	1.50	3
D010006DAL	£52.70	1mm x 6mm 2-Flute Carbide Slot Drill with Back Clearance	1.0	6.0	39	1.50	3
D010009DAL	£66.75	1mm x 9mm 2-Flute Carbide Slot Drill with Back Clearance	1.0	9.0	39	1.50	3
D010012DAL	£66.75	1mm x 12mm 2-Flute Carbide Slot Drill with Back Clearance	1.0	12.0	60	1.50	3
D012006DAL	£52.70	1.2mm x 6mm 2-Flute Carbide Slot Drill with Back Clearance	1.2	6.0	39	1.80	3
D012009DAL	£66.75	1.2mm x 9mm 2-Flute Carbide Slot Drill with Back Clearance	1.2	9	39	1.80	3
D014006DAL	£52.70	1.4mm x 6mm 2-Flute Carbide Slot Drill with Back Clearance	1.4	6	39	2.10	3
D014009DAL	£66.75	1.4mm x 9mm 2-Flute Carbide Slot Drill with Back Clearance	1.4	9	39	2.10	3
D015006DAL	£52.70	1.5mm x 6mm 2-Flute Carbide Slot Drill with Back Clearance	1.5	6	39	2.25	3
D015009DAL	£66.75	1.5mm x 9mm 2-Flute Carbide Slot Drill with Back Clearance	1.5	9	39	2.25	3
D015012DAL	£80.80	1.5mm x 12mm 2-Flute Carbide Slot Drill with Back Clearance	1.5	12	60	2.25	3
D018009DAL	£66.75	1.8mm x 9mm 2-Flute Carbide Slot Drill with Back Clearance	1.8	9	39	2.70	3
D018012DAL	£69.30	1.8mm x 12mm 2-Flute Carbide Slot Drill with Back Clearance	1.8	12	39	2.70	3
D020009DAL	£66.75	2mm x 9mm 2-Flute Carbide Slot Drill with Back Clearance	2.0	9	39	3.00	3
D020012DAL	£69.30	2mm x 12mm 2-Flute Carbide Slot Drill with Back Clearance	2.0	12	39	3.00	3
D020015DAL	£80.80	2mm x 15mm 2-Flute Carbide Slot Drill with Back Clearance	2.0	15	60	3.00	3
D025015DAL	£80.80	2.5mm x 15mm 2-Flute Carbide Slot Drill with Back Clearance	2.5	15	60	3.75	3

(Prices do not include VAT)

SLOT DRILLS & END MILLS

2 Flute Ball Nose Miniature Slot Drills

Supplied by Magafor

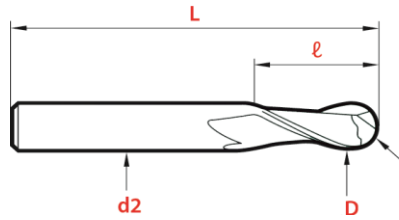
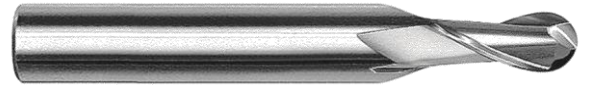

Code 8529 Carbide K15 Micrograin

Range D	Tolerance			
	D	ℓ	L	d2
0.1-0.25	-0.02	+0.10	-1	h6
0.3-0.4	-0.02	+0.15	-1	h6
0.5-0.6	-0.02	+0.20	-1	h6
0.7-2.0	-0.02	+0.30	-1	h6
≥2.5	-0.02	+0.50	-1	h6

Product Code	Price	Description	D	L	ℓ	d2	R
D0010DDM	£107.65	0.1mm 2-Flute Carbide Ball Nose Miniature Slot Drill	0.10	39	0.2	3	0.050
D0015DDM	£92.30	0.15mm 2-Flute Carbide Ball Nose Miniature Slot Drill	0.15	39	0.3	3	0.075
D0020DDM	£82.05	0.2mm 2-Flute Carbide Ball Nose Miniature Slot Drill	0.20	39	0.5	3	0.100
D0025DDM	£78.20	0.25mm 2-Flute Carbide Ball Nose Miniature Slot Drill	0.25	39	0.5	3	0.125
D0030DDM	£68.00	0.3mm 2-Flute Carbide Ball Nose Miniature Slot Drill	0.30	39	1.0	3	0.150
D0035DDM	£64.20	0.35mm 2-Flute Carbide Ball Nose Miniature Slot Drill	0.35	39	1.0	3	0.175
D0040DDM	£50.15	0.4mm 2-Flute Carbide Ball Nose Miniature Slot Drill	0.40	39	1.0	3	0.200
D0050DDM	£46.35	0.5mm 2-Flute Carbide Ball Nose Miniature Slot Drill	0.50	39	1.5	3	0.250
D0060DDM	£46.35	0.6mm 2-Flute Carbide Ball Nose Miniature Slot Drill	0.60	39	1.5	3	0.300
D0070DDM	£46.35	0.7mm 2-Flute Carbide Ball Nose Miniature Slot Drill	0.70	39	2.0	3	0.350
D0080DDM	£46.35	0.8mm 2-Flute Carbide Ball Nose Miniature Slot Drill	0.80	39	2.0	3	0.400
D0090DDM	£46.35	0.9mm 2-Flute Carbide Ball Nose Miniature Slot Drill	0.90	39	2.5	3	0.450
D0100DDM	£45.00	1mm 2-Flute Carbide Ball Nose Miniature Slot Drill	1.00	39	3.0	3	0.500
D0110DDM	£46.35	1.1mm 2-Flute Carbide Ball Nose Miniature Slot Drill	1.10	39	3.0	3	0.550
D0120DDM	£46.35	1.2mm 2-Flute Carbide Ball Nose Miniature Slot Drill	1.20	39	4.0	3	0.600
D0140DDM	£46.35	1.4mm 2-Flute Carbide Ball Nose Miniature Slot Drill	1.40	39	4.0	3	0.700
D0150DDM	£45.00	1.5mm 2-Flute Carbide Ball Nose Miniature Slot Drill	1.50	39	4.0	3	0.750
D0160DDM	£46.35	1.6mm 2-Flute Carbide Ball Nose Miniature Slot Drill	1.60	39	4.0	3	0.800
D0180DDM	£46.35	1.8mm 2-Flute Carbide Ball Nose Miniature Slot Drill	1.80	39	5.0	3	0.900
D0200DDM	£45.00	2mm 2-Flute Carbide Ball Nose Miniature Slot Drill	2.00	39	5.0	3	1.000
D0250DDM	£56.50	2.5mm 2-Flute Carbide Ball Nose Miniature Slot Drill	2.50	39	7.0	3	1.250
D0300DDM	£56.50	3mm 2-Flute Carbide Ball Nose Miniature Slot Drill	3.00	44	10.0	4	1.500
D0350DDM	£69.30	3.5mm 2-Flute Carbide Ball Nose Miniature Slot Drill	3.50	44	10.0	4	1.750
D0400DDM	£57.80	4mm 2-Flute Carbide Ball Nose Miniature Slot Drill	4.00	52	12.0	5	2.000
D0450DDM	£76.95	4.5mm 2-Flute Carbide Ball Nose Miniature Slot Drill	4.50	52	12.0	5	2.250
D0500DDM	£66.15	5mm 2-Flute Carbide Ball Nose Miniature Slot Drill	5.00	52	14.0	6	2.500
D0550DDM	£79.50	5.5mm 2-Flute Carbide Ball Nose Miniature Slot Drill	5.50	52	14.0	6	2.750

(Prices do not include VAT)

SLOT DRILLS & END MILLS

2 Flute Stub Miniature Ball Nose Slot Drills

Supplied by Magafor

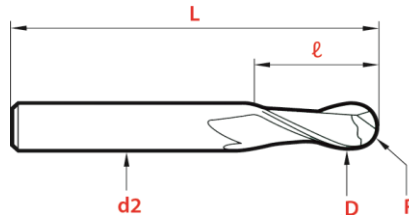

Code 8527 Carbide K15 Micrograin

Range D	Tolerance			
	D	ℓ	L	d2
0.1-0.25	-0.02	+0.10	-1	h6
0.3-0.4	-0.02	+0.15	-1	h6
0.5-0.6	-0.02	+0.20	-1	h6
0.7-2.0	-0.02	+0.30	-1	h6

Product Code	Price	Description	D	L	ℓ	d2	R
D0010DGM	£84.65	0.1mm 2-Flute Carbide Stub Miniature Ball Nose Slot Drill	0.10	39	0.10	3	0.050
D0015DGM	£73.10	0.15mm 2-Flute Carbide Stub Miniature Ball Nose Slot Drill	0.15	39	0.20	3	0.075
D0020DGM	£65.45	0.2mm 2-Flute Carbide Stub Miniature Ball Nose Slot Drill	0.20	39	0.30	3	0.100
D0025DGM	£62.85	0.25mm 2-Flute Carbide Stub Miniature Ball Nose Slot Drill	0.25	39	0.35	3	0.125
D0030DGM	£54.00	0.3mm 2-Flute Carbide Stub Miniature Ball Nose Slot Drill	0.30	39	0.45	3	0.150
D0040DGM	£39.90	0.4mm 2-Flute Carbide Stub Miniature Ball Nose Slot Drill	0.40	39	0.60	3	0.200
D0050DGM	£36.10	0.5mm 2-Flute Carbide Stub Miniature Ball Nose Slot Drill	0.50	39	0.75	3	0.250
D0060DGM	£34.80	0.6mm 2-Flute Carbide Stub Miniature Ball Nose Slot Drill	0.60	39	0.90	3	0.300
D0070DGM	£34.80	0.7mm 2-Flute Carbide Stub Miniature Ball Nose Slot Drill	0.70	39	1.05	3	0.350
D0080DGM	£34.80	0.8mm 2-Flute Carbide Stub Miniature Ball Nose Slot Drill	0.80	39	1.20	3	0.400
D0090DGM	£34.80	0.9mm 2-Flute Carbide Stub Miniature Ball Nose Slot Drill	0.90	39	1.35	3	0.450
D0100DGM	£34.80	1mm 2-Flute Carbide Stub Miniature Ball Nose Slot Drill	1.00	39	1.50	3	0.500
D0120DGM	£34.80	1.2mm 2-Flute Carbide Stub Miniature Ball Nose Slot Drill	1.20	39	1.80	3	0.600
D0150DGM	£34.80	1.5mm 2-Flute Carbide Stub Miniature Ball Nose Slot Drill	1.50	39	2.25	3	0.750
D0200DGM	£36.10	2mm 2-Flute Carbide Stub Miniature Ball Nose Slot Drill	2.00	39	3.00	3	1.000

(Prices do not include VAT)

SLOT DRILLS & END MILLS

2 Flute Long Miniature Ball Nose Slot Drills with Back Clearance

Supplied by Magafor

Code 8527-D Carbide K15 Micrograin

Also available in Graph X and Hard X

Range D	Tolerance			
	D	ø1	L	d2
0.4-0.6	-0.02	+0.20	-1	h6
0.8-2.0	-0.02	+0.30	-1	h6
2.5-3.0	-0.02	+0.50	-1	h6

Product Code	Price	Description	D	ø2	L	ø1	d2	R
D004002DBL	£61.65	0.4mm x 2mm 2-Flute Carbide Long Miniature Ball Nose Slot Drill with Back Clearance	0.4	2.0	39	0.60	3	0.20
D005002DBL	£61.65	0.5mm x 2mm 2-Flute Carbide Long Miniature Ball Nose Slot Drill with Back Clearance	0.5	2.0	39	0.75	3	0.25
D005004DBL	£61.65	0.5mm x 4mm 2-Flute Carbide Long Miniature Ball Nose Slot Drill with Back Clearance	0.5	4.0	39	0.75	3	0.25
D005006DBL	£89.70	0.5mm x 6mm 2-Flute Carbide Long Miniature Ball Nose Slot Drill with Back Clearance	0.5	6.0	60	0.75	3	0.25
D006004DBL	£61.65	0.6mm x 4mm 2-Flute Carbide Long Miniature Ball Nose Slot Drill with Back Clearance	0.6	4.0	39	0.90	3	0.30
D008004DBL	£61.65	0.8mm x 4mm 2-Flute Carbide Long Miniature Ball Nose Slot Drill with Back Clearance	0.8	4.0	39	1.20	3	0.40
D008006DBL	£76.95	0.8mm x 6mm 2-Flute Carbide Long Miniature Ball Nose Slot Drill with Back Clearance	0.8	6.0	39	1.20	3	0.40
D008009DBL	£89.70	0.8mm x 9mm 2-Flute Carbide Long Miniature Ball Nose Slot Drill with Back Clearance	0.8	9.0	60	1.20	3	0.40
D010004DBL	£61.65	1mm x 4mm 2-Flute Carbide Long Miniature Ball Nose Slot Drill with Back Clearance	1.0	4.0	39	1.50	3	0.50
D010005DBL	£61.65	1mm x 5mm 2-Flute Carbide Long Miniature Ball Nose Slot Drill with Back Clearance	1.0	5.0	39	1.50	3	0.50
D010006DBL	£61.65	1mm x 6mm 2-Flute Carbide Long Miniature Ball Nose Slot Drill with Back Clearance	1.0	6.0	39	1.50	3	0.50
D010009DBL	£76.95	1mm x 9mm 2-Flute Carbide Long Miniature Ball Nose Slot Drill with Back Clearance	1.0	9.0	39	1.50	3	0.50
D010012DBL	£89.70	1mm x 12mm 2-Flute Carbide Long Miniature Ball Nose Slot Drill with Back Clearance	1.0	12.0	60	1.50	3	0.50
D012006DBL	£61.65	1.2mm x 6mm 2-Flute Carbide Long Miniature Ball Nose Slot Drill with Back Clearance	1.2	6.0	39	1.80	3	0.60
D014007DBL	£76.95	1.4mm x 7mm 2-Flute Carbide Long Miniature Ball Nose Slot Drill with Back Clearance	1.4	7.0	44	2.10	4	0.70
D015006DBL	£61.65	1.5mm x 6mm 2-Flute Carbide Long Miniature Ball Nose Slot Drill with Back Clearance	1.5	6.0	39	2.25	3	0.75
D015007DBL	£76.95	1.5mm x 7.5mm 2-Flute Carbide Long Miniature Ball Nose Slot Drill with Back Clearance	1.5	7.5	44	2.25	4	0.75
D015009DBL	£76.95	1.5mm x 9mm 2-Flute Carbide Long Miniature Ball Nose Slot Drill with Back Clearance	1.5	9.0	39	2.25	3	0.75
D015012DBL	£89.70	1.5mm x 12mm 2-Flute Carbide Long Miniature Ball Nose Slot Drill with Back Clearance	1.5	12.0	60	2.25	3	0.75
D016008DBL	£85.90	1.6mm x 8mm 2-Flute Carbide Long Miniature Ball Nose Slot Drill with Back Clearance	1.6	8.0	44	2.40	4	0.80
D018009DBL	£85.90	1.8mm x 9mm 2-Flute Carbide Long Miniature Ball Nose Slot Drill with Back Clearance	1.8	9.0	44	2.70	4	0.90
D020009DBL	£76.95	2mm x 9mm 2-Flute Carbide Long Miniature Ball Nose Slot Drill with Back Clearance	2.0	9.0	39	3.00	3	1.00

(Prices do not include VAT)

SLOT DRILLS & END MILLS

2 Flute Long Miniature Ball Nose Slot Drills with Back Clearance

Supplied by Magafor

Code 8527-D Carbide K15 Micrograin

Also available in Graph X and Hard X

Range D	Tolerance			
	D	ø1	L	d2
0.4-0.6	-0.02	+0.20	-1	h6
0.8-2.0	-0.02	+0.30	-1	h6
2.5-3.0	-0.02	+0.50	-1	h6

Product Code	Price	Description	D	ø2	L	ø1	d2	R
D020010DBL	£85.90	2mm x 10mm 2-Flute Carbide Long Miniature Ball Nose Slot Drill with Back Clearance	2.0	10.0	44	3.00	4	1.00
D020012DBL	£76.95	2mm x 12mm 2-Flute Carbide Long Miniature Ball Nose Slot Drill with Back Clearance	2.0	12.0	39	3.00	3	1.00
D020015DBL	£89.70	2mm x 15mm 2-Flute Carbide Long Miniature Ball Nose Slot Drill with Back Clearance	2.0	15.0	60	3.00	3	1.00
D025012DBL	£85.90	2.5mm x 12mm 2-Flute Carbide Long Miniature Ball Nose Slot Drill with Back Clearance	2.5	12.0	44	3.75	4	1.25
D025015DBL	£89.70	2.5mm x 15mm 2-Flute Carbide Long Miniature Ball Nose Slot Drill with Back Clearance	2.5	15.0	60	3.75	3	1.25
D030015DBL	£89.70	3mm x 15mm 2-Flute Carbide Long Miniature Ball Nose Slot Drill with Back Clearance	3.0	15.0	44	4.50	4	1.50

(Prices do not include VAT)

SLOT DRILLS & END MILLS

Miniature Taper Ball Nose End Mills

Supplied by Magafor

Code 8501 1° Short Series Carbide K15
 Code 8503 1°30' Short Series Carbide K15
 Code 8505 2° Short Series Carbide K15

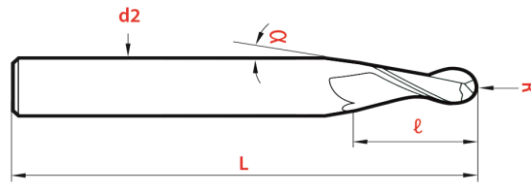

Tolerance			
R	L	ℓ	d2
±0.01	-1	+1	h6

Product Code	Price	Description	α	R	L	ℓ	d2
DT0050S100	£82.55	0.5mm 1° Short Series Carbide Miniature Taper Ball Nose End Mill	1°	0.50	39	4	3
DT0075S100	£84.90	0.75mm 1° Short Series Carbide Miniature Taper Ball Nose End Mill	1°	0.75	39	6	3
DT0100S100	£88.50	1mm 1° Short Series Carbide Miniature Taper Ball Nose End Mill	1°	1.00	39	8	3
DT0125S100	£108.45	1.25mm 1° Short Series Carbide Miniature Taper Ball Nose End Mill	1°	1.25	44	10	4
DT0150S100	£110.80	1.5mm 1° Short Series Carbide Miniature Taper Ball Nose End Mill	1°	1.50	44	12	4
DT0200S100	£113.15	2mm 1° Short Series Carbide Miniature Taper Ball Nose End Mill	1°	2.00	52	16	5
DT0050S130	£82.55	0.5mm 1°30' Short Series Carbide Miniature Taper Ball Nose End Mill	1°30'	0.50	39	4	3
DT0075S130	£84.90	0.75mm 1°30' Short Series Carbide Miniature Taper Ball Nose End Mill	1°30'	0.75	39	6	3
DT0100S130	£88.50	1mm 1°30' Short Series Carbide Miniature Taper Ball Nose End Mill	1°30'	1.00	39	8	3
DT0125S130	£108.45	1.25mm 1°30' Short Series Carbide Miniature Taper Ball Nose End Mill	1°30'	1.25	44	10	4
DT0150S130	£110.80	1.5mm 1°30' Short Series Carbide Miniature Taper Ball Nose End Mill	1°30'	1.50	44	12	4
DT0200S130	£113.15	2mm 1°30' Short Series Carbide Miniature Taper Ball Nose End Mill	1°30'	2.00	52	16	5
DT0050S200	£82.55	0.5mm 2° Short Series Carbide Miniature Taper Ball Nose End Mill	2°	0.50	39	4	3
DT0075S200	£84.90	0.75mm 2° Short Series Carbide Miniature Taper Ball Nose End Mill	2°	0.75	39	6	3
DT0100S200	£88.50	1mm 2° Short Series Carbide Miniature Taper Ball Nose End Mill	2°	1.00	39	8	3
DT0125S200	£108.45	1.25mm 2° Short Series Carbide Miniature Taper Ball Nose End Mill	2°	1.25	44	10	4
DT0150S200	£110.80	1.5mm 2° Short Series Carbide Miniature Taper Ball Nose End Mill	2°	1.50	44	12	4
DT0200S200	£113.15	2mm 2° Short Series Carbide Miniature Taper Ball Nose End Mill	2°	2.00	52	16	5

(Prices do not include VAT)

SLOT DRILLS & END MILLS

Miniature Taper Ball Nose End Mills

Supplied by Magafor

Code 8502 1° Long Series Carbide K15
 Code 8504 1°30' Long Series Carbide K15
 Code 8506 2° Long Series Carbide K15

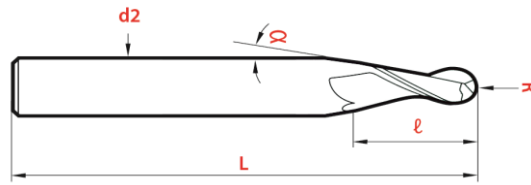

Tolerance			
R	L	ℓ	d2
±0.01	-1	+1	h6

Product Code	Price	Description	α	R	L	ℓ	d2
DT0100L100	£115.45	1mm 1° Long Series Carbide Miniature Taper Ball Nose End Mill	1°	1.00	50	12	4
DT0150L100	£129.60	1.5mm 1° Long Series Carbide Miniature Taper Ball Nose End Mill	1°	1.50	60	18	5
DT0200L100	£141.35	2mm 1° Long Series Carbide Miniature Taper Ball Nose End Mill	1°	2.00	75	24	6
DT0100L130	£115.45	1mm 1°30' Long Series Carbide Miniature Taper Ball Nose End Mill	1°30'	1.00	50	12	4
DT0150L130	£129.60	1.5mm 1°30' Long Series Carbide Miniature Taper Ball Nose End Mill	1°30'	1.50	60	18	5
DT0200L130	£141.35	2mm 1°30' Long Series Carbide Miniature Taper Ball Nose End Mill	1°30'	2.00	75	24	6
DT0100L200	£115.45	1mm 2° Long Series Carbide Miniature Taper Ball Nose End Mill	2°	1.00	50	12	4
DT0150L200	£129.60	1.5mm 2° Long Series Carbide Miniature Taper Ball Nose End Mill	2°	1.50	60	18	5
DT0200L200	£141.35	2mm 2° Long Series Carbide Miniature Taper Ball Nose End Mill	2°	2.00	75	24	6

(Prices do not include VAT)

SLOT DRILLS & END MILLS

High Speed Miniature Carbide Cutters

Supplied by Magafor

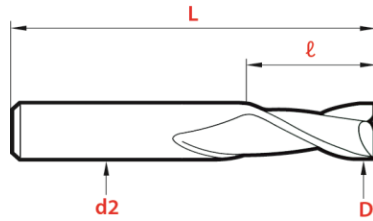
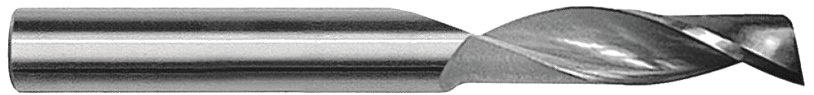

Code 8515 Miniature Single Flute
Router Carbide K15 Micrograin

Range D	Tolerance			
	D	ℓ	L	d2
0.5-0.6	h10	+0.2	-1	h6
0.8-2.0	h10	+0.3	-1	h6
2.5-3.0	h10	+0.5	-1	h6

Product Code	Price	Description	D	L	ℓ	d2
D0050DPM	£42.65	0.5mm Single-Flute High Speed Miniature Carbide Router	0.5	39	1.5	3
D0060DPM	£42.65	0.6mm Single-Flute High Speed Miniature Carbide Router	0.6	39	1.5	3
D0080DPM	£42.65	0.8mm Single-Flute High Speed Miniature Carbide Router	0.8	39	2.0	3
D0100DPM	£37.95	1mm Single-Flute High Speed Miniature Carbide Router	1.0	39	3.0	3
D0120DPM	£43.80	1.2mm Single-Flute High Speed Miniature Carbide Router	1.2	39	4.0	3
D0140DPM	£43.80	1.4mm Single-Flute High Speed Miniature Carbide Router	1.4	39	4.0	3
D0150DPM	£37.95	1.5mm Single-Flute High Speed Miniature Carbide Router	1.5	39	4.0	3
D0160DPM	£43.80	1.6mm Single-Flute High Speed Miniature Carbide Router	1.6	39	4.0	3
D0180DPM	£43.80	1.8mm Single-Flute High Speed Miniature Carbide Router	1.8	39	5.0	3
D0200DPM	£40.30	2mm Single-Flute High Speed Miniature Carbide Router	2.0	39	5.0	3
D0250DPM	£43.80	2.5mm Single-Flute High Speed Miniature Carbide Router	2.5	39	7.0	3
D0300DPM	£46.15	3mm Single-Flute High Speed Miniature Carbide Router	3.0	39	10.0	3

(Prices do not include VAT)

SLOT DRILLS & END MILLS

3-Flute Precision Miniature Carbide Cutters

Supplied by Magafor

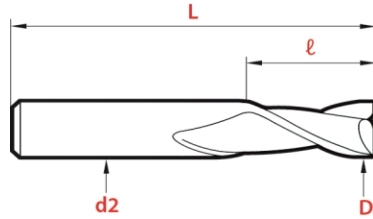

Code 8533 Miniature 3 Flute
End Mill Carbide K15 Micrograin

Range D	Tolerance			
	D	ℓ	L	d2
0.5-0.6	-0.01	+0.2	-1	h6
0.8-2.0	-0.01	+0.3	-1	h6
2.5-3.0	-0.01	+0.5	-1	h6

Product Code	Price	Description	D	L	ℓ	d2
D0050DRM	£42.45	0.5mm 3-Flute High Speed Miniature Carbide End Mill	0.5	39	1.5	3
D0060DRM	£42.45	0.6mm 3-Flute High Speed Miniature Carbide End Mill	0.6	39	1.5	3
D0070DRM	£42.45	0.7mm 3-Flute High Speed Miniature Carbide End Mill	0.7	39	2.0	3
D0080DRM	£42.45	0.8mm 3-Flute High Speed Miniature Carbide End Mill	0.8	39	2.0	3
D0090DRM	£42.45	0.9mm 3-Flute High Speed Miniature Carbide End Mill	0.9	39	2.5	3
D0100DRM	£37.35	1mm 3-Flute High Speed Miniature Carbide End Mill	1.0	39	3.0	3
D0110DRM	£42.45	1.1mm 3-Flute High Speed Miniature Carbide End Mill	1.1	39	3.0	3
D0120DRM	£42.45	1.2mm 3-Flute High Speed Miniature Carbide End Mill	1.2	39	4.0	3
D0130DRM	£42.45	1.3mm 3-Flute High Speed Miniature Carbide End Mill	1.3	39	4.0	3
D0140DRM	£42.45	1.4mm 3-Flute High Speed Miniature Carbide End Mill	1.4	39	4.0	3
D0150DRM	£37.35	1.5mm 3-Flute High Speed Miniature Carbide End Mill	1.5	39	4.0	3
D0160DRM	£42.45	1.6mm 3-Flute High Speed Miniature Carbide End Mill	1.6	39	5.0	3
D0170DRM	£42.45	1.7mm 3-Flute High Speed Miniature Carbide End Mill	1.7	39	5.0	3
D0180DRM	£42.45	1.8mm 3-Flute High Speed Miniature Carbide End Mill	1.8	39	5.0	3
D0190DRM	£42.45	1.9mm 3-Flute High Speed Miniature Carbide End Mill	1.9	39	5.0	3
D0200DRM	£39.90	2mm 3-Flute High Speed Miniature Carbide End Mill	2.0	39	5.0	3
D0210DRM	£54.00	2.1mm 3-Flute High Speed Miniature Carbide End Mill	2.1	39	6.0	3
D0220DRM	£54.00	2.2mm 3-Flute High Speed Miniature Carbide End Mill	2.2	39	6.0	3
D0230DRM	£54.00	2.3mm 3-Flute High Speed Miniature Carbide End Mill	2.3	39	6.0	3
D0240DRM	£54.00	2.4mm 3-Flute High Speed Miniature Carbide End Mill	2.4	39	6.0	3
D0250DRM	£50.15	2.5mm 3-Flute High Speed Miniature Carbide End Mill	2.5	39	7.0	3
D0260DRM	£59.05	2.6mm 3-Flute High Speed Miniature Carbide End Mill	2.6	39	7.0	3
D0270DRM	£59.05	2.7mm 3-Flute High Speed Miniature Carbide End Mill	2.7	39	7.0	3
D0280DRM	£59.05	2.8mm 3-Flute High Speed Miniature Carbide End Mill	2.8	39	7.0	3
D0290DRM	£59.05	2.9mm 3-Flute High Speed Miniature Carbide End Mill	2.9	39	7.0	3
D0300DRM	£56.50	3mm 3-Flute High Speed Miniature Carbide End Mill	3.0	44	10.0	4

(Prices do not include VAT)

SLOT DRILLS & END MILLS

2 Flute Carbide Coated End Mills 45° Spiral

Supplied by Magafor



Code 8528 Carbide K15 Micrograin
Alu-Titan 45° Spiral

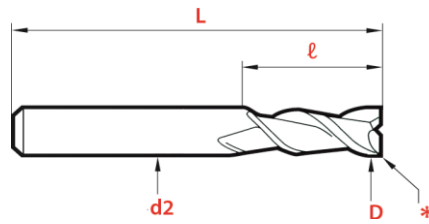

Range D	Tolerance			
	D	ℓ	L	d2
0.5-0.6	-0.01	+0.2	-1	h6
0.8-2.0	-0.01	+0.3	-1	h6
2.5	-0.01	+0.5	-1	h6

Product Code	Price	Description	D	L	ℓ	d2
D0050DSM	£47.30	0.5mm 2-Flute Precision Carbide End Mill with Alu-Titan Coating	0.5	39	1.5	3
D0060DSM	£48.50	0.6mm 2-Flute Precision Carbide End Mill with Alu-Titan Coating	0.6	39	1.5	3
D0080DSM	£49.70	0.8mm 2-Flute Precision Carbide End Mill with Alu-Titan Coating	0.8	39	2.0	3
D0100DSM	£52.05	1mm 2-Flute Precision Carbide End Mill with Alu-Titan Coating	1.0	39	3.0	3
D0120DSM	£53.20	1.2mm 2-Flute Precision Carbide End Mill with Alu-Titan Coating	1.2	39	4.0	3
D0150DSM	£54.35	1.5mm 2-Flute Precision Carbide End Mill with Alu-Titan Coating	1.5	39	4.0	3
D0200DSM	£57.85	2mm 2-Flute Precision Carbide End Mill with Alu-Titan Coating	2.0	39	5.0	3
D0250DSM	£63.75	2.5mm 2-Flute Precision Carbide End Mill with Alu-Titan Coating	2.5	39	7.0	3

* Front Chamfer = 0.05 x D

SLOT DRILLS & END MILLS

2/3 Flute Carbide Hard Alloys Miniature End Mill

Supplied by Magafor

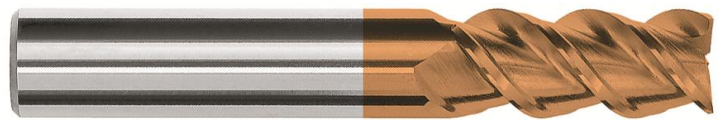

Code 8530-H Carbide K15 Micrograin
Hard-X Coated 45° Spiral

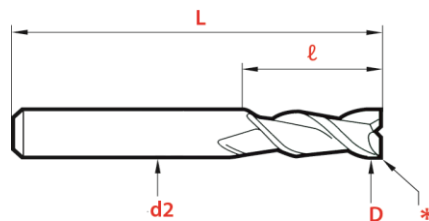

Range D	Tolerance			
	D	ℓ	L	d2
0.5-0.6	-0.01	+0.2	-1	h6
0.8-2.0	-0.01	+0.3	-1	h6
2.5	-0.01	+0.5	-1	h6

Product Code	Price	Description	D	L	ℓ	d2
D0050DTM	£42.45	0.5mm 2-Flute Precision Carbide End Mill with Hard-X Coating	0.5	39	1.5	3
D0060DTM	£43.75	0.6mm 2-Flute Precision Carbide End Mill with Hard-X Coating	0.6	39	1.5	3
D0080DTM	£45.00	0.8mm 2-Flute Precision Carbide End Mill with Hard-X Coating	0.8	39	2.0	3
D0100DTM	£47.60	1mm 3-Flute Precision Carbide End Mill with Hard-X Coating	1.0	39	3.0	3
D0120DTM	£48.85	1.2mm 3-Flute Precision Carbide End Mill with Hard-X Coating	1.2	39	4.0	3
D0150DTM	£50.15	1.5mm 3-Flute Precision Carbide End Mill with Hard-X Coating	1.5	39	4.0	3
D0200DTM	£54.00	2mm 3-Flute Precision Carbide End Mill with Hard-X Coating	2.0	39	5.0	3
D0250DTM	£60.35	2.5mm 3-Flute Precision Carbide End Mill with Hard-X Coating	2.5	39	5.0	3

* Front Chamfer = 0.05 x D

(Prices do not include VAT)

SLOT DRILLS & END MILLS

Miniature Carbide Corner Rounding Cutters

Supplied by Magafor

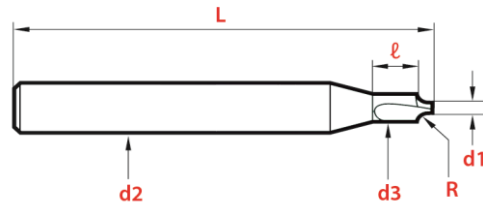

Tolerance			
R	d2	d3	L
-0.01	-1	+0.02	h6

Code 8550 Carbide K15 Micrograin

Product Code	Price	Description	R	d1	d2	d3	ℓ	L
DC0010M	£69.30	0.1mm Miniature Carbide Corner Rounding Cutter	0.10	0.5	3	0.8	2.5	50
DC0015M	£69.30	0.15mm Miniature Carbide Corner Rounding Cutter	0.15	0.5	3	0.9	2.5	50
DC0020M	£69.30	0.2mm Miniature Carbide Corner Rounding Cutter	0.20	0.5	3	1.0	2.5	50
DC0025M	£66.15	0.25mm Miniature Carbide Corner Rounding Cutter	0.25	0.5	3	1.1	2.5	50
DC0030M	£66.15	0.3mm Miniature Carbide Corner Rounding Cutter	0.30	0.5	3	1.2	2.5	50
DC0040M	£66.15	0.4mm Miniature Carbide Corner Rounding Cutter	0.40	0.5	3	1.4	2.5	50
DC0050M	£66.15	0.5mm Miniature Carbide Corner Rounding Cutter	0.50	0.5	3	1.6	2.5	50
DC0060M	£66.15	0.6mm Miniature Carbide Corner Rounding Cutter	0.60	0.5	3	1.8	3.0	50
DC0070M	£66.15	0.7mm Miniature Carbide Corner Rounding Cutter	0.70	0.5	3	2.0	3.0	50
DC0075M	£66.15	0.75mm Miniature Carbide Corner Rounding Cutter	0.75	0.5	3	2.1	3.0	50
DC0080M	£66.15	0.8mm Miniature Carbide Corner Rounding Cutter	0.80	0.8	3	2.5	4.0	50
DC0090M	£66.15	0.9mm Miniature Carbide Corner Rounding Cutter	0.90	0.8	3	2.7	4.0	50
DC0100M	£66.15	1mm Miniature Carbide Corner Rounding Cutter	1.00	0.8	3	2.9	4.0	50
DC0125M	£82.05	1.25mm Miniature Carbide Corner Rounding Cutter	1.25	0.8	4	3.4	4.0	50
DC0150M	£82.05	1.5mm Miniature Carbide Corner Rounding Cutter	1.50	1.5	5	4.6	6.0	50
DC0175M	£82.05	1.75mm Miniature Carbide Corner Rounding Cutter	1.75	1.5	6	5.1	6.0	50
DC0200M	£82.05	2mm Miniature Carbide Corner Rounding Cutter	2.00	1.5	6	5.6	8.0	50
DC0225M	£100.55	2.25mm Miniature Carbide Corner Rounding Cutter	2.25	1.5	8	6.1	10.0	50
DC0250M	£100.55	2.5mm Miniature Carbide Corner Rounding Cutter	2.50	1.5	8	6.6	10.0	50
DC0300M	£100.55	3mm Miniature Carbide Corner Rounding Cutter	3.00	1.5	8	7.6	10.0	50
DC0400M	£145.95	4mm Miniature Carbide Corner Rounding Cutter	4.00	1.9	10	10.0	-	55
DC0500M	£161.25	5mm Miniature Carbide Corner Rounding Cutter	5.00	1.9	12	12.0	-	63
DC0600M	£190.65	6mm Miniature Carbide Corner Rounding Cutter	6.00	1.9	14	14.0	-	74

(Prices do not include VAT)

SLOT DRILLS & END MILLS

Miniature Carbide Corner Rounding Cutters

Supplied by Magafor

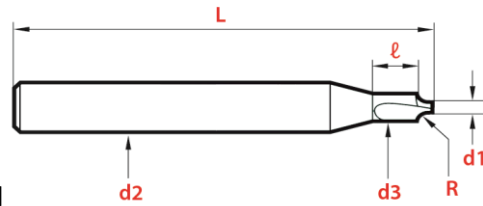

Tolerance			
R	d2	d3	L
-0.01	-1	+0.02	h6

Code 8550H Carbide K15 Micrograin Hard-X Coated

Product Code	Price	Description	R	d1	d2	d3	ℓ	L
DC0010MH	£76.95	0.1mm Miniature Carbide Corner Rounding Cutter with Hard-X Coating	0.10	0.5	3	0.8	2.5	50
DC0015MH	£76.95	0.15mm Miniature Carbide Corner Rounding Cutter with Hard-X Coating	0.15	0.5	3	0.9	2.5	50
DC0020MH	£76.95	0.2mm Miniature Carbide Corner Rounding Cutter with Hard-X Coating	0.20	0.5	3	1.0	2.5	50
DC0025MH	£73.75	0.25mm Miniature Carbide Corner Rounding Cutter with Hard-X Coating	0.25	0.5	3	1.1	2.5	50
DC0030MH	£73.75	0.3mm Miniature Carbide Corner Rounding Cutter with Hard-X Coating	0.30	0.5	3	1.2	2.5	50
DC0040MH	£73.75	0.4mm Miniature Carbide Corner Rounding Cutter with Hard-X Coating	0.40	0.5	3	1.4	2.5	50
DC0050MH	£73.75	0.5mm Miniature Carbide Corner Rounding Cutter with Hard-X Coating	0.50	0.5	3	1.6	2.5	50
DC0060MH	£73.75	0.6mm Miniature Carbide Corner Rounding Cutter with Hard-X Coating	0.60	0.5	3	1.8	3.0	50
DC0070MH	£73.75	0.7mm Miniature Carbide Corner Rounding Cutter with Hard-X Coating	0.70	0.5	3	2.0	3.0	50
DC0075MH	£73.75	0.75mm Miniature Carbide Corner Rounding Cutter with Hard-X Coating	0.75	0.5	3	2.1	3.0	50
DC0080MH	£73.75	0.8mm Miniature Carbide Corner Rounding Cutter with Hard-X Coating	0.80	0.8	3	2.5	4.0	50
DC0090MH	£73.75	0.9mm Miniature Carbide Corner Rounding Cutter with Hard-X Coating	0.90	0.8	3	2.7	4.0	50
DC0100MH	£73.75	1mm Miniature Carbide Corner Rounding Cutter with Hard-X Coating	1.00	0.8	3	2.9	4.0	50
DC0125MH	£89.70	1.25mm Miniature Carbide Corner Rounding Cutter with Hard-X Coating	1.25	0.8	4	3.4	4.0	50
DC0150MH	£89.70	1.5mm Miniature Carbide Corner Rounding Cutter with Hard-X Coating	1.50	1.5	5	4.6	6.0	50
DC0175MH	£89.70	1.75mm Miniature Carbide Corner Rounding Cutter with Hard-X Coating	1.75	1.5	6	5.1	6.0	50
DC0200MH	£89.70	2mm Miniature Carbide Corner Rounding Cutter with Hard-X Coating	2.00	1.5	6	5.6	8.0	50
DC0225MH	£108.25	2.25mm Miniature Carbide Corner Rounding Cutter with Hard-X Coating	2.25	1.5	8	6.1	10.0	50
DC0250MH	£108.25	2.5mm Miniature Carbide Corner Rounding Cutter with Hard-X Coating	2.50	1.5	8	6.6	10.0	50
DC0300MH	£108.25	3mm Miniature Carbide Corner Rounding Cutter with Hard-X Coating	3.00	1.5	8	7.6	10.0	50
DC0400MH	£153.60	4mm Miniature Carbide Corner Rounding Cutter with Hard-X Coating	4.00	1.9	10	10.0	-	55
DC0500MH	£155.45	5mm Miniature Carbide Corner Rounding Cutter with Hard-X Coating	5.00	1.9	12	12.0	-	63
DC0600MH	£182.45	6mm Miniature Carbide Corner Rounding Cutter with Hard-X Coating	6.00	1.9	14	14.0	-	74

(Prices do not include VAT)

SLOT DRILLS & END MILLS

Multi V Carbide Cutters

Supplied by Magafor

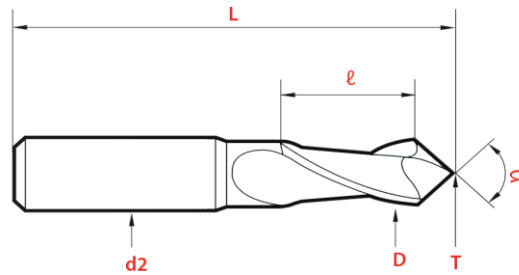
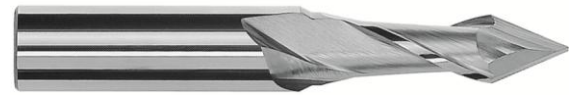

Tolerance			
D	α	L	d2
h9	$\pm 1^\circ$	± 1	h6

Code 8040 40° Carbide K15 Micrograin

Product Code	Price	Description	D	α	L	l	d2	T
DM005D	£73.10	0.5mm 40° Multi V Carbide Cutter	0.5	40°	39	1.0	3.00	0.05
DM010D	£71.85	1mm 40° Multi V Carbide Cutter	1.0	40°	39	2.0	3.00	0.10
DM015D	£71.85	1.5mm 40° Multi V Carbide Cutter	1.5	40°	39	3.0	3.00	0.15
DM020D	£71.85	2mm 40° Multi V Carbide Cutter	2.0	40°	39	4.0	3.00	0.20
DM030D	£91.00	3mm 40° Multi V Carbide Cutter	3.0	40°	50	6.0	4.00	0.30

SLOT DRILLS & END MILLS

Multi V Carbide Cutters

Supplied by Magafor

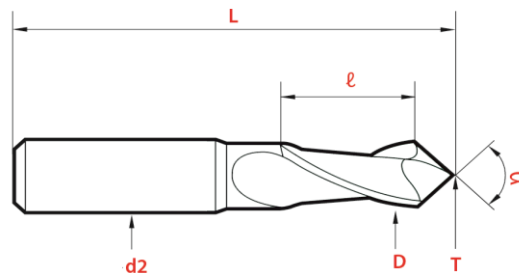
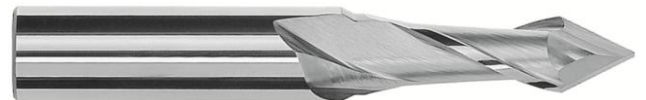

Range	Tolerance			
	D	α	L	d2
0.1-10	h9	$\pm 1^\circ$	± 1	h6
12-20	d9	$\pm 1^\circ$	± 1	h6

Code 8088 60° Carbide K15 Micrograin

Product Code	Price	Description	D	α	L	l	d2	T
DM005A	£65.45	0.5mm 60° Multi V Carbide Cutter	0.5	60°	39	1.0	3.00	0.05
DM008A	£68.00	0.8mm 60° Multi V Carbide Cutter	0.8	60°	39	1.6	3.00	0.08
DM010A	£61.65	1mm 60° Multi V Carbide Cutter	1.0	60°	39	2.0	3.00	0.10
DM012A	£68.00	1.2mm 60° Multi V Carbide Cutter	1.2	60°	39	2.4	3.00	0.12
DM015A	£61.65	1.5mm 60° Multi V Carbide Cutter	1.5	60°	39	3.0	3.00	0.15
DM018A	£68.00	1.8mm 60° Multi V Carbide Cutter	1.8	60°	39	3.6	3.00	0.18
DM020A	£61.65	2mm 60° Multi V Carbide Cutter	2.0	60°	39	4.0	3.00	0.20
DM025A	£62.85	2.5mm 60° Multi V Carbide Cutter	2.5	60°	39	5.0	3.00	0.25
DM030A	£83.30	3mm 60° Multi V Carbide Cutter	3.0	60°	50	6.0	4.00	0.30
DM040A	£85.90	4mm 60° Multi V Carbide Cutter	4.0	60°	50	8.0	5.00	0.40
DM050A	£98.65	5mm 60° Multi V Carbide Cutter	5.0	60°	50	10.0	6.00	0.50
DM060A	£111.45	6mm 60° Multi V Carbide Cutter	6.0	60°	60	12.0	8.00	0.60
DM080A	£162.55	8mm 60° Multi V Carbide Cutter	8.0	60°	70	16.0	10.00	0.80
DM100A	£186.80	10mm 60° Multi V Carbide Cutter	10.0	60°	70	18.0	12.00	1.00
DM120A	£186.80	12mm 60° Multi V Carbide Cutter	12.0	60°	70	20.0	12.00	1.20
DM160A	£274.90	16mm 60° Multi V Carbide Cutter	16.0	60°	80	26.0	16.00	1.60
DM200A	£493.35	20mm 60° Multi V Carbide Cutter	20.0	60°	100	32.0	20.00	2.00

(Prices do not include VAT)

SLOT DRILLS & END MILLS

Multi V Carbide Cutters

Supplied by Magafor



Code 8088H 60° Carbide K15 Micrograin
with Hard-X Coating

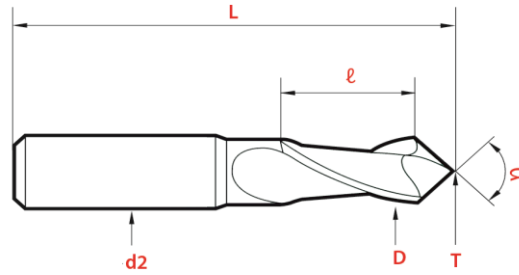

Range	Tolerance			
	D	α	L	d2
0.1-10	h9	±1°	±1	h6
12-20	d9	±1°	±1	h6

Product Code	Price	Description	D	α	L	ℓ	d2	T
DM005AH	£65.95	0.5mm 60° Multi V Carbide Cutter with Hard-X Coating	0.5	60°	39	1.0	3.00	0.05
DM010AH	£68.00	1mm 60° Multi V Carbide Cutter with Hard-X Coating	1.0	60°	39	2.0	3.00	0.10
DM015AH	£68.00	1.5mm 60° Multi V Carbide Cutter with Hard-X Coating	1.5	60°	39	3.0	3.00	0.15
DM020AH	£68.00	2mm 60° Multi V Carbide Cutter with Hard-X Coating	2.0	60°	39	4.0	3.00	0.20
DM030AH	£89.70	3mm 60° Multi V Carbide Cutter with Hard-X Coating	3.0	60°	50	6.0	4.00	0.30
DM050AH	£105.05	5mm 60° Multi V Carbide Cutter with Hard-X Coating	5.0	60°	50	10.0	6.00	0.50
DM060AH	£117.85	6mm 60° Multi V Carbide Cutter with Hard-X Coating	6.0	60°	60	12.0	8.00	0.60
DM080AH	£171.45	8mm 60° Multi V Carbide Cutter with Hard-X Coating	8.0	60°	70	16.0	10.00	0.80
DM120AH	£200.85	12mm 60° Multi V Carbide Cutter with Hard-X Coating	12.0	60°	70	20.0	12.00	1.20
DM160AH	£295.35	16mm 60° Multi V Carbide Cutter with Hard-X Coating	16.0	60°	80	26.0	16.00	1.60

(Prices do not include VAT)

SLOT DRILLS & END MILLS

Multi V Carbide Cutters

Supplied by Magafor

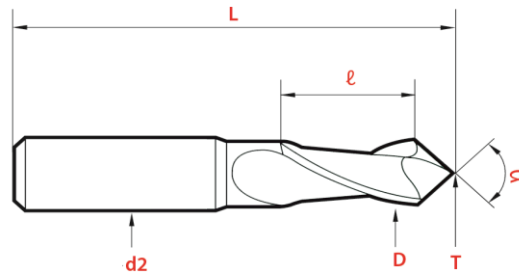

Range D	Tolerance			
	D	α	L	d2
0.1-10	h9	$\pm 1^\circ$	± 1	h6
12-20	d9	$\pm 1^\circ$	± 1	h6

Code 8090 90° Carbide K15 Micrograin

Product Code	Price	Description	D	α	L	l	d2	T
DM001B	£97.40	0.1mm 90° Multi V Carbide Cutter	0.1	90°	39	0.2	3.00	0.01
DM002B	£70.60	0.2mm 90° Multi V Carbide Cutter	0.2	90°	39	0.4	3.00	0.02
DM003B	£59.05	0.3mm 90° Multi V Carbide Cutter	0.3	90°	39	0.6	3.00	0.03
DM004B	£52.70	0.4mm 90° Multi V Carbide Cutter	0.4	90°	39	0.8	3.00	0.04
DM005B	£39.15	0.5mm 90° Multi V Carbide Cutter	0.5	90°	39	1.0	3.00	0.05
DM006B	£39.15	0.6mm 90° Multi V Carbide Cutter	0.6	90°	39	1.2	3.00	0.06
DM007B	£39.15	0.7mm 90° Multi V Carbide Cutter	0.7	90°	39	1.4	3.00	0.07
DM008B	£39.15	0.8mm 90° Multi V Carbide Cutter	0.8	90°	39	1.6	3.00	0.08
DM009B	£39.15	0.9mm 90° Multi V Carbide Cutter	0.9	90°	39	1.8	3.00	0.09
DM010B	£39.15	1mm 90° Multi V Carbide Cutter	1.0	90°	39	2.0	3.00	0.10
DM012B	£39.15	1.2mm 90° Multi V Carbide Cutter	1.2	90°	39	2.4	3.00	0.12
DM013B	£45.00	1.3mm 90° Multi V Carbide Cutter	1.3	90°	39	2.6	3.00	0.13
DM014B	£39.15	1.4mm 90° Multi V Carbide Cutter	1.4	90°	39	2.8	3.00	0.14
DM015B	£39.15	1.5mm 90° Multi V Carbide Cutter	1.5	90°	39	3.0	3.00	0.15
DM016B	£39.15	1.6mm 90° Multi V Carbide Cutter	1.6	90°	39	3.2	3.00	0.16
DM018B	£39.15	1.8mm 90° Multi V Carbide Cutter	1.8	90°	39	3.6	3.00	0.18
DM019B	£45.00	1.9mm 90° Multi V Carbide Cutter	1.9	90°	39	3.8	3.00	0.19
DM020B	£39.15	2mm 90° Multi V Carbide Cutter	2.0	90°	39	4.0	3.00	0.20
DM025B	£40.80	2.5mm 90° Multi V Carbide Cutter	2.5	90°	39	5.0	3.00	0.25
DM030B	£51.90	3mm 90° Multi V Carbide Cutter	3.0	90°	50	6.0	4.00	0.30
DM040B	£53.85	4mm 90° Multi V Carbide Cutter	4.0	90°	50	8.0	5.00	0.40
DM048B	£62.60	3/16" 90° Multi V Carbide Cutter	3/16"	90°	50	9.5	6.35	0.50
DM050B	£62.60	5mm 90° Multi V Carbide Cutter	5.0	90°	50	10.0	6.00	0.50
DM060B	£69.00	6mm 90° Multi V Carbide Cutter	6.0	90°	60	12.0	8.00	0.60
DM064B	£74.60	1/4" 90° Multi V Carbide Cutter	1/4"	90°	60	12.0	7.93	0.60
DM079B	£94.80	5/16" 90° Multi V Carbide Cutter	5/16"	90°	70	16.0	9.52	0.80
DM080B	£96.00	8mm 90° Multi V Carbide Cutter	8.0	90°	70	16.0	10.00	0.80
DM095B	£138.60	3/8" 90° Multi V Carbide Cutter	3/8"	90°	70	19.0	12.70	1.00
DM100B	£119.85	10mm 90° Multi V Carbide Cutter	10.0	90°	70	18.0	12.00	1.00
DM120B	£135.50	12mm 90° Multi V Carbide Cutter	12.0	90°	70	20.0	12.00	1.20
DM1270B	£142.05	1/2" 90° Multi V Carbide Cutter	1/2"	90°	70	20.0	12.70	1.30
DM159B	£169.05	5/8" 90° Multi V Carbide Cutter	5/8"	90°	80	25.0	15.87	1.60
DM160B	£172.05	16mm 90° Multi V Carbide Cutter	16.0	90°	80	26.0	16.00	1.60
DM200B	£299.75	20mm 90° Multi V Carbide Cutter	20.0	90°	100	32.0	20.00	2.00

(Prices do not include VAT)

SLOT DRILLS & END MILLS

Multi V Carbide Cutters

Supplied by Magafor



Code 8090H 90° Carbide K15 Micrograin
with Hard-X Coating

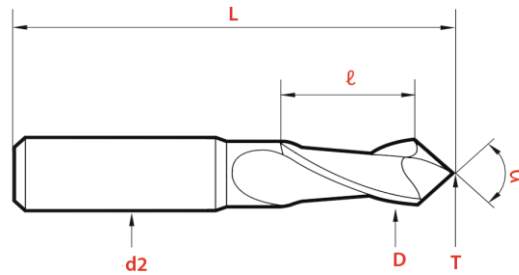

Range D	Tolerance			
	D	α	L	d2
0.1-10	h9	$\pm 1^\circ$	± 1	h6
12-20	d9	$\pm 1^\circ$	± 1	h6

Product Code	Price	Description	D	α	L	l	d2	T
DM001BH	£103.75	0.1mm 90° Multi V Carbide Cutter with Hard-X Coating	0.1	90°	39	0.2	3.00	0.01
DM002BH	£76.95	0.2mm 90° Multi V Carbide Cutter with Hard-X Coating	0.2	90°	39	0.4	3.00	0.02
DM003BH	£65.45	0.3mm 90° Multi V Carbide Cutter with Hard-X Coating	0.3	90°	39	0.6	3.00	0.03
DM004BH	£59.05	0.4mm 90° Multi V Carbide Cutter with Hard-X Coating	0.4	90°	39	0.8	3.00	0.04
DM005BH	£51.40	0.5mm 90° Multi V Carbide Cutter with Hard-X Coating	0.5	90°	39	1.0	3.00	0.05
DM006BH	£51.40	0.6mm 90° Multi V Carbide Cutter with Hard-X Coating	0.6	90°	39	1.2	3.00	0.06
DM007BH	£51.40	0.7mm 90° Multi V Carbide Cutter with Hard-X Coating	0.7	90°	39	1.4	3.00	0.07
DM008BH	£51.40	0.8mm 90° Multi V Carbide Cutter with Hard-X Coating	0.8	90°	39	1.6	3.00	0.08
DM009BH	£51.40	0.9mm 90° Multi V Carbide Cutter with Hard-X Coating	0.9	90°	39	1.8	3.00	0.09
DM010BH	£51.40	1mm 90° Multi V Carbide Cutter with Hard-X Coating	1.0	90°	39	2.0	3.00	0.10
DM015BH	£51.40	1.5mm 90° Multi V Carbide Cutter with Hard-X Coating	1.5	90°	39	3.0	3.00	0.15
DM020BH	£51.40	2mm 90° Multi V Carbide Cutter with Hard-X Coating	2.0	90°	39	4.0	3.00	0.20
DM025BH	£52.70	2.5mm 90° Multi V Carbide Cutter with Hard-X Coating	2.5	90°	39	5.0	3.00	0.25
DM030BH	£54.60	3mm 90° Multi V Carbide Cutter with Hard-X Coating	3.0	90°	50	6.0	4.00	0.30
DM040BH	£56.20	4mm 90° Multi V Carbide Cutter with Hard-X Coating	4.0	90°	50	8.0	5.00	0.40
DM050BH	£64.20	5mm 90° Multi V Carbide Cutter with Hard-X Coating	5.0	90°	50	10.0	6.00	0.50
DM060BH	£70.60	6mm 90° Multi V Carbide Cutter with Hard-X Coating	6.0	90°	60	12.0	8.00	0.60
DM080BH	£103.15	8mm 90° Multi V Carbide Cutter with Hard-X Coating	8.0	90°	70	16.0	10.00	0.80
DM100BH	£131.25	10mm 90° Multi V Carbide Cutter with Hard-X Coating	10.0	90°	70	18.0	12.00	1.00
DM120BH	£128.05	12mm 90° Multi V Carbide Cutter with Hard-X Coating	12.0	90°	70	20.0	12.00	1.20

SLOT DRILLS & END MILLS

Multi V Carbide Cutters

Supplied by Magafor

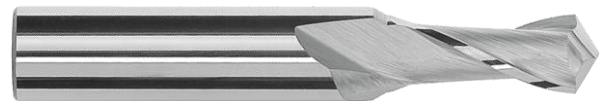

Code 8095 100° Carbide K15 Micrograin

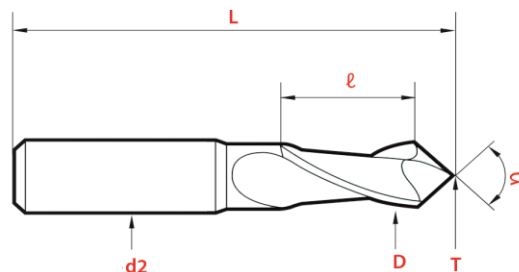

Range D	Tolerance			
	D	α	L	d2
0.1-10	h9	$\pm 1^\circ$	± 1	h6
12-20	d9	$\pm 1^\circ$	± 1	h6

Product Code	Price	Description	D	α	L	l	d2	T
DM060E	£133.15	6mm 100° Multi V Carbide Cutter	6.0	100°	60	12.0	8.00	0.60
DM100E	£248.10	10mm 100° Multi V Carbide Cutter	10.0	100°	70	18.0	12.00	1.00

(Prices do not include VAT)

SLOT DRILLS & END MILLS

Multi V Carbide Cutters

Supplied by Magafor

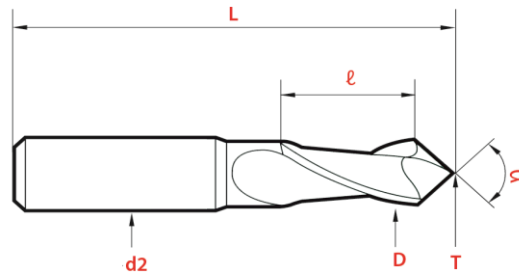
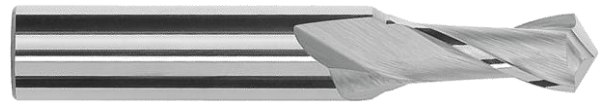

Range D	Tolerance			
	D	α	L	d2
0.1-10	h9	$\pm 1^\circ$	± 1	h6
12-20	d9	$\pm 1^\circ$	± 1	h6

Code 8095 120° Carbide K15 Micrograin

Product Code	Price	Description	D	α	L	l	d2	T
DM010C	£55.25	1mm 120° Multi V Carbide Cutter	1.0	120°	39	2.0	3.00	0.10
DM015C	£55.25	1.5mm 120° Multi V Carbide Cutter	1.5	120°	39	3.0	3.00	0.15
DM020C	£55.25	2mm 120° Multi V Carbide Cutter	2.0	120°	39	4.0	3.00	0.20
DM025C	£56.50	2.5mm 120° Multi V Carbide Cutter	2.5	120°	39	5.0	3.00	0.25
DM030C	£73.10	3mm 120° Multi V Carbide Cutter	3.0	120°	50	6.0	4.00	0.30
DM040C	£75.70	4mm 120° Multi V Carbide Cutter	4.0	120°	50	8.0	5.00	0.40
DM050C	£88.45	5mm 120° Multi V Carbide Cutter	5.0	120°	50	10.0	6.00	0.50
DM060C	£99.95	6mm 120° Multi V Carbide Cutter	6.0	120°	60	12.0	8.00	0.60
DM080C	£147.20	8mm 120° Multi V Carbide Cutter	8.0	120°	70	16.0	10.00	0.80
DM100C	£184.25	10mm 120° Multi V Carbide Cutter	10.0	120°	70	18.0	12.00	1.00
DM120C	£184.25	12mm 120° Multi V Carbide Cutter	12.0	120°	70	20.0	12.00	1.20
DM160C	£272.35	16mm 120° Multi V Carbide Cutter	16.0	120°	80	26.0	16.00	1.60
DM200C	£484.35	20mm 120° Multi V Carbide Cutter	20.0	120°	100	32.0	20.00	2.00

SLOT DRILLS & END MILLS

Multi V Carbide Cutters

Supplied by Magafor

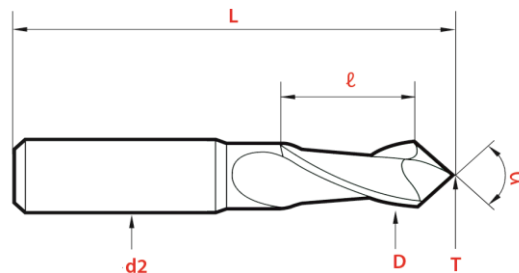

D	Tolerance		
	α	L	d2
h9	$\pm 1^\circ$	± 1	h6

Code 8095 120° Carbide K15 Micrograin
with Hard-X Coating

Product Code	Price	Description	D	α	L	l	d2	T
DM040CH	£82.05	4mm 120° Multi V Carbide Cutter with Hard-X Coating	4.0	120°	50	8.0	5.00	0.40
DM050CH	£94.85	5mm 120° Multi V Carbide Cutter with Hard-X Coating	5.0	120°	50	10.0	6.00	0.50
DM060CH	£106.35	6mm 120° Multi V Carbide Cutter with Hard-X Coating	6.0	120°	60	12.0	8.00	0.60

(Prices do not include VAT)

SLOT DRILLS & END MILLS

Biface Cutters

Supplied by Magafor

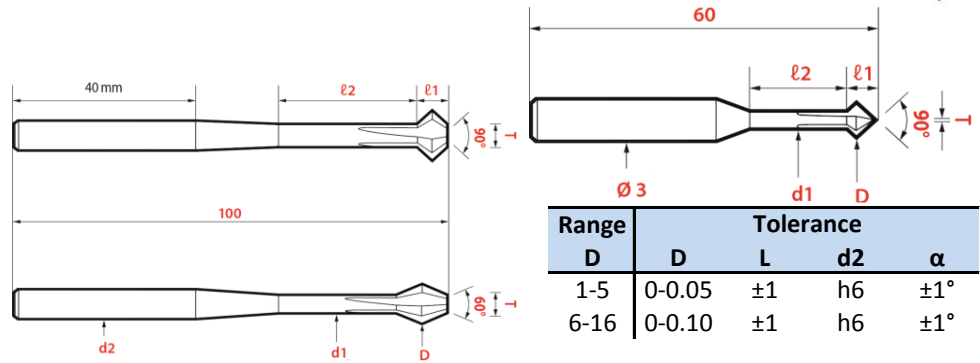

Code 8480 90° Carbide K15 Micrograin
 Code 8490 90° Carbide K15 Micrograin
 Code 8460 60° Carbide K15 Micrograin

Product Code	Price	Description	D	d2	d1	T	L	l1	l2	α
M84800100	£63.20	1mm 90° Mini Carbide Biface Cutter	1	3	0.7	0.3	60	0.5	5	90°
M84800150	£60.85	1.5mm 90° Mini Carbide Biface Cutter	1.5	3	1.1	0.45	60	0.73	6	90°
M84800180	£58.50	1.8mm 90° Mini Carbide Biface Cutter	1.8	3	1.4	0.6	60	0.75	8	90°
M84800200	£58.50	2mm 90° Mini Carbide Biface Cutter	2	3	1.5	0.6	60	0.95	8	90°
M84800280	£58.50	2.8mm 90° Mini Carbide Biface Cutter	2.8	3	2.1	0.9	60	1.3	10	90°
M84800300	£58.50	3mm 90° Mini Carbide Biface Cutter	3	3	2.1	0.9	60	1.5	10	90°
M84900028	£72.00	2.8mm 90° Standard Carbide Biface Cutter	2.8	6	2.2	1.2	100	1.1	10	90°
M84900030	£72.00	3mm 90° Standard Carbide Biface Cutter	3	6	2.2	1.2	100	1.3	10	90°
M84900038	£74.35	3.8mm 90° Standard Carbide Biface Cutter	3.8	6	2.9	1.6	100	1.55	12	90°
M84900040	£74.35	4mm 90° Standard Carbide Biface Cutter	4	6	2.9	1.6	100	1.75	12	90°
M84900048	£77.90	4.8mm 90° Standard Carbide Biface Cutter	4.8	6	3.4	2	100	2.1	15	90°
M84900050	£77.90	5mm 90° Standard Carbide Biface Cutter	5	6	3.4	2	100	2.3	15	90°
M84900058	£82.55	5.8mm 90° Standard Carbide Biface Cutter	5.8	6	3.8	2.4	100	2.7	18	90°
M84900060	£82.55	6mm 90° Standard Carbide Biface Cutter	6	6	3.8	2.4	100	2.9	18	90°
M84900078	£106.65	7.8mm 90° Standard Carbide Biface Cutter	7.8	6	4.9	4.9	100	2.8	34	90°
M84900080	£106.65	8mm 90° Standard Carbide Biface Cutter	8	6	4.9	4.9	100	3	34	90°
M84900098	£130.75	9.8mm 90° Standard Carbide Biface Cutter	9.8	6	5.9	5.9	100	3.8	34	90°
M84900100	£130.75	10mm 90° Standard Carbide Biface Cutter	10	6	5.9	5.9	100	4	34	90°
M84900118	£157.80	11.8mm 90° Standard Carbide Biface Cutter	11.8	6	5.9	5.9	100	5.8	34	90°
M84900120	£157.80	12mm 90° Standard Carbide Biface Cutter	12	6	5.9	5.9	100	6	34	90°
M84900158	£210.65	15.8mm 90° Standard Carbide Biface Cutter	15.8	10	7.9	7.9	100	7.8	34	90°
M84900160	£210.65	16mm 90° Standard Carbide Biface Cutter	16	10	7.9	7.9	100	8	34	90°
M84600050	£99.60	5mm 60° Standard Carbide Biface Cutter	5	3	3.4	3.4	100	2.8	15	60°
M84600080	£130.75	8mm 60° Standard Carbide Biface Cutter	8	6	4.9	4.9	100	5.4	34	60°
M84600120	£191.85	12mm 60° Standard Carbide Biface Cutter	12	6	5.9	5.9	100	10.6	34	60°

(Prices do not include VAT)

SLOT DRILLS & END MILLS

2 Flute Miniature Slot Drills

Supplied by Magafor

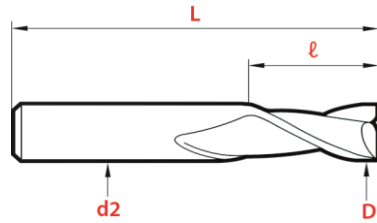
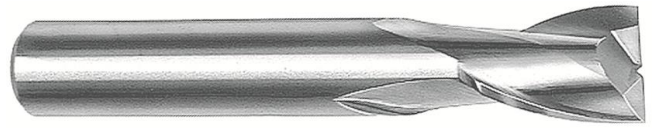

Code 500 HSS M35 5% Cob

Tolerance			
D	L	ℓ	d2
±0.01	±1	+1	h6

Product Code	Price	Description	D	L	ℓ	d2
D0030BAM	£32.95	0.3mm HSS 2-Flute Miniature Slot Drill	0.30	37	1	3
D0040BAM	£32.95	0.4mm HSS 2-Flute Miniature Slot Drill	0.40	37	1	3
D0050BAM	£32.95	0.5mm HSS 2-Flute Miniature Slot Drill	0.50	37	1.5	3
D0060BAM	£32.95	0.6mm HSS 2-Flute Miniature Slot Drill	0.60	37	1.5	3
D0070BAM	£32.95	0.7mm HSS 2-Flute Miniature Slot Drill	0.70	37	2	4
D0080BAM	£32.95	0.8mm HSS 2-Flute Miniature Slot Drill	0.80	37	2	4
D0090BAM	£32.95	0.9mm HSS 2-Flute Miniature Slot Drill	0.90	37	2.5	4
D0095BAM	£32.95	0.95mm HSS 2-Flute Miniature Slot Drill	0.95	37	2.5	4
D0100BAM	£32.95	1mm HSS 2-Flute Miniature Slot Drill	1.00	37	3	4
D0105BAM	£32.95	1.05mm HSS 2-Flute Miniature Slot Drill	1.05	37	3	4
D0110BAM	£32.95	1.1mm HSS 2-Flute Miniature Slot Drill	1.10	37	3	4
D0120BAM	£32.95	1.2mm HSS 2-Flute Miniature Slot Drill	1.20	37	4	4
D0125BAM	£32.95	1.25mm HSS 2-Flute Miniature Slot Drill	1.25	37	4	4
D0130BAM	£32.95	1.3mm HSS 2-Flute Miniature Slot Drill	1.30	37	4	4
D0140BAM	£32.95	1.4mm HSS 2-Flute Miniature Slot Drill	1.40	37	4	4
D0145BAM	£32.95	1.45mm HSS 2-Flute Miniature Slot Drill	1.45	37	4	4
D0150BAM	£32.95	1.5mm HSS 2-Flute Miniature Slot Drill	1.50	37	4	4
D0155BAM	£32.95	1.55mm HSS 2-Flute Miniature Slot Drill	1.55	37	4	4
D0158BAM	£32.95	1/16" HSS 2-Flute Miniature Slot Drill	1/16"	37	4	4
D0160BAM	£32.95	1.6mm HSS 2-Flute Miniature Slot Drill	1.60	37	4	4
D0170BAM	£32.95	1.7mm HSS 2-Flute Miniature Slot Drill	1.70	37	5	4
D0175BAM	£32.95	1.75mm HSS 2-Flute Miniature Slot Drill	1.75	37	5	4
D0180BAM	£32.95	1.8mm HSS 2-Flute Miniature Slot Drill	1.80	37	5	4
D0190BAM	£32.95	1.9mm HSS 2-Flute Miniature Slot Drill	1.90	37	5	4
D0195BAM	£32.95	1.95mm HSS 2-Flute Miniature Slot Drill	1.95	37	5	4
D0200BAM	£32.95	2mm HSS 2-Flute Miniature Slot Drill	2.00	37	5	4
D0205BAM	£32.95	2.05mm HSS 2-Flute Miniature Slot Drill	2.05	37	5	4
D0210BAM	£32.95	2.1mm HSS 2-Flute Miniature Slot Drill	2.10	37	5	4
D0220BAM	£32.95	2.2mm HSS 2-Flute Miniature Slot Drill	2.20	37	5	4
D0225BAM	£32.95	2.25mm HSS 2-Flute Miniature Slot Drill	2.25	40	7	4
D0230BAM	£32.95	2.3mm HSS 2-Flute Miniature Slot Drill	2.30	40	7	4
D0240BAM	£32.95	2.4mm HSS 2-Flute Miniature Slot Drill	2.40	40	7	4
D0250BAM	£32.95	2.5mm HSS 2-Flute Miniature Slot Drill	2.50	40	7	4
D0260BAM	£32.95	2.6mm HSS 2-Flute Miniature Slot Drill	2.60	40	7	4
D0270BAM	£32.95	2.7mm HSS 2-Flute Miniature Slot Drill	2.70	40	7	4
D0275BAM	£32.95	2.75mm HSS 2-Flute Miniature Slot Drill	2.75	44	8	5
D0280BAM	£32.95	2.8mm HSS 2-Flute Miniature Slot Drill	2.80	44	8	5
D0290BAM	£32.95	2.9mm HSS 2-Flute Miniature Slot Drill	2.90	44	8	5
D0295BAM	£32.95	2.95mm HSS 2-Flute Miniature Slot Drill	2.95	44	8	5
D0300BAM	£32.95	3mm HSS 2-Flute Miniature Slot Drill	3.00	44	8	5
D0305BAM	£32.95	3.05mm HSS 2-Flute Miniature Slot Drill	3.05	44	8	5
D0310BAM	£32.95	3.1mm HSS 2-Flute Miniature Slot Drill	3.10	44	8	5
D0317BAM	£32.95	1/8" HSS 2-Flute Miniature Slot Drill	1/8"	44	8	5
D0320BAM	£32.95	3.2mm HSS 2-Flute Miniature Slot Drill	3.20	44	8	5

(Prices do not include VAT)

SLOT DRILLS & END MILLS

2 Flute Miniature Slot Drills

Supplied by Magafor

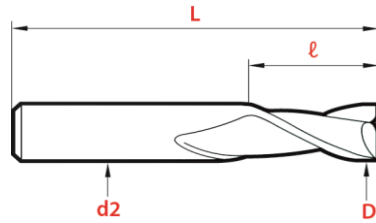

Code 500 HSS M35 5% Cob

Tolerance			
D	L	ℓ	d2
±0.01	±1	+1	h6

Product Code	Price	Description	D	L	ℓ	d2
D0325BAM	£32.95	3.25mm HSS 2-Flute Miniature Slot Drill	3.25	44	10	5
D0330BAM	£32.95	3.3mm HSS 2-Flute Miniature Slot Drill	3.30	44	10	5
D0340BAM	£32.95	3.4mm HSS 2-Flute Miniature Slot Drill	3.40	44	10	5
D0350BAM	£32.95	3.5mm HSS 2-Flute Miniature Slot Drill	3.50	44	10	5
D0360BAM	£32.95	3.6mm HSS 2-Flute Miniature Slot Drill	3.60	44	10	5
D0370BAM	£32.95	3.7mm HSS 2-Flute Miniature Slot Drill	3.70	44	10	5
D0380BAM	£38.35	3.8mm HSS 2-Flute Miniature Slot Drill	3.80	51	12	6
D0390BAM	£38.35	3.9mm HSS 2-Flute Miniature Slot Drill	3.90	51	12	6
D0395BAM	£38.35	3.95mm HSS 2-Flute Miniature Slot Drill	3.95	51	12	6
D0400BAM	£38.35	4mm HSS 2-Flute Miniature Slot Drill	4.00	51	12	6
D0405BAM	£38.35	4.05mm HSS 2-Flute Miniature Slot Drill	4.05	51	12	6
D0410BAM	£38.35	4.1mm HSS 2-Flute Miniature Slot Drill	4.10	51	12	6
D0420BAM	£38.35	4.2mm HSS 2-Flute Miniature Slot Drill	4.20	51	12	6
D0430BAM	£38.35	4.3mm HSS 2-Flute Miniature Slot Drill	4.30	51	12	6
D0440BAM	£38.35	4.4mm HSS 2-Flute Miniature Slot Drill	4.40	51	12	6
D0450BAM	£38.35	4.5mm HSS 2-Flute Miniature Slot Drill	4.50	51	12	6
D0460BAM	£38.35	4.6mm HSS 2-Flute Miniature Slot Drill	4.60	51	12	6
D0470BAM	£38.35	4.7mm HSS 2-Flute Miniature Slot Drill	4.70	51	12	6
D0476BAM	£38.35	3/16" HSS 2-Flute Miniature Slot Drill	3/16"	52	14	6
D0480BAM	£38.35	4.8mm HSS 2-Flute Miniature Slot Drill	4.80	52	14	6
D0490BAM	£38.35	4.9mm HSS 2-Flute Miniature Slot Drill	4.90	52	14	6
D0495BAM	£38.35	4.95mm HSS 2-Flute Miniature Slot Drill	4.95	52	14	6
D0500BAM	£38.35	5mm HSS 2-Flute Miniature Slot Drill	5.00	52	14	6
D0505BAM	£38.35	5.05mm HSS 2-Flute Miniature Slot Drill	5.05	52	14	6
D0510BAM	£38.35	5.1mm HSS 2-Flute Miniature Slot Drill	5.10	52	14	6
D0520BAM	£38.35	5.2mm HSS 2-Flute Miniature Slot Drill	5.20	52	14	6
D0530BAM	£38.35	5.3mm HSS 2-Flute Miniature Slot Drill	5.30	52	14	6
D0540BAM	£38.35	5.4mm HSS 2-Flute Miniature Slot Drill	5.40	52	14	6
D0550BAM	£38.35	5.5mm HSS 2-Flute Miniature Slot Drill	5.50	52	14	6
D0560BAM	£38.35	5.6mm HSS 2-Flute Miniature Slot Drill	5.60	52	14	6
D0570BAM	£38.35	5.7mm HSS 2-Flute Miniature Slot Drill	5.70	52	14	6
D0580BAM	£40.50	5.8mm HSS 2-Flute Miniature Slot Drill	5.80	60	16	8
D0590BAM	£40.50	5.9mm HSS 2-Flute Miniature Slot Drill	5.90	60	16	8
D0595BAM	£40.50	5.95mm HSS 2-Flute Miniature Slot Drill	5.95	60	16	8
D0600BAM	£40.50	6mm HSS 2-Flute Miniature Slot Drill	6.00	60	16	8
D0605BAM	£40.50	6.05mm HSS 2-Flute Miniature Slot Drill	6.05	60	16	8
D0610BAM	£40.50	6.1mm HSS 2-Flute Miniature Slot Drill	6.10	60	16	8
D0620BAM	£40.50	6.2mm HSS 2-Flute Miniature Slot Drill	6.20	60	16	8
D0630BAM	£40.50	6.3mm HSS 2-Flute Miniature Slot Drill	6.30	60	16	8
D0635BAM	£40.50	1/4" HSS 2-Flute Miniature Slot Drill	1/4"	60	16	8
D0640BAM	£40.50	6.4mm HSS 2-Flute Miniature Slot Drill	6.40	60	16	8
D0650BAM	£40.50	6.5mm HSS 2-Flute Miniature Slot Drill	6.50	60	16	8
D0660BAM	£40.50	6.6mm HSS 2-Flute Miniature Slot Drill	6.60	60	16	8
D0670BAM	£40.50	6.7mm HSS 2-Flute Miniature Slot Drill	6.70	60	16	8

(Prices do not include VAT)

SLOT DRILLS & END MILLS

2 Flute Miniature Slot Drills

Supplied by Magafor

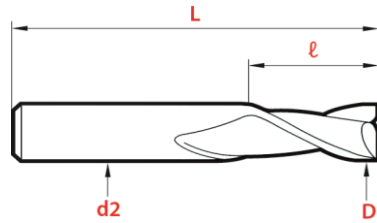

Code 500 HSS M35 5% Cob

Tolerance			
D	L	ℓ	d2
±0.01	±1	+1	h6

Product Code	Price	Description	D	L	ℓ	d2
D0680BAM	£40.50	6.8mm HSS 2-Flute Miniature Slot Drill	6.80	60	16	8
D0690BAM	£40.50	6.9mm HSS 2-Flute Miniature Slot Drill	6.90	60	16	8
D0700BAM	£40.50	7mm HSS 2-Flute Miniature Slot Drill	7.00	60	16	8
D0710BAM	£40.50	7.1mm HSS 2-Flute Miniature Slot Drill	7.10	60	16	8
D0720BAM	£40.50	7.2mm HSS 2-Flute Miniature Slot Drill	7.20	60	16	8
D0730BAM	£40.50	7.3mm HSS 2-Flute Miniature Slot Drill	7.30	60	16	8
D0740BAM	£40.50	7.4mm HSS 2-Flute Miniature Slot Drill	7.40	60	16	8
D0750BAM	£40.50	7.5mm HSS 2-Flute Miniature Slot Drill	7.50	60	16	8
D0760BAM	£40.50	7.6mm HSS 2-Flute Miniature Slot Drill	7.60	60	16	8
D0770BAM	£40.50	7.7mm HSS 2-Flute Miniature Slot Drill	7.70	60	16	8
D0780BAM	£47.60	7.8mm HSS 2-Flute Miniature Slot Drill	7.80	61	18	8
D0790BAM	£47.60	7.9mm HSS 2-Flute Miniature Slot Drill	7.90	61	18	8
D0794BAM	£47.60	5/16" HSS 2-Flute Miniature Slot Drill	5/16"	61	18	8
D0800BAM	£47.60	8mm HSS 2-Flute Miniature Slot Drill	8.00	61	18	8
D0810BAM	£52.00	8.1mm HSS 2-Flute Miniature Slot Drill	8.10	69	18	10
D0820BAM	£52.00	8.2mm HSS 2-Flute Miniature Slot Drill	8.20	69	18	10
D0830BAM	£52.00	8.3mm HSS 2-Flute Miniature Slot Drill	8.30	69	18	10
D0840BAM	£52.00	8.4mm HSS 2-Flute Miniature Slot Drill	8.40	69	18	10
D0850BAM	£52.00	8.5mm HSS 2-Flute Miniature Slot Drill	8.50	69	18	10
D0860BAM	£52.00	8.6mm HSS 2-Flute Miniature Slot Drill	8.60	69	18	10
D0870BAM	£52.00	8.7mm HSS 2-Flute Miniature Slot Drill	8.70	69	18	10
D0880BAM	£52.00	8.8mm HSS 2-Flute Miniature Slot Drill	8.80	69	18	10
D0890BAM	£52.00	8.9mm HSS 2-Flute Miniature Slot Drill	8.90	69	18	10
D0900BAM	£52.00	9mm HSS 2-Flute Miniature Slot Drill	9.00	69	18	10
D0910BAM	£52.00	9.1mm HSS 2-Flute Miniature Slot Drill	9.10	69	18	10
D0920BAM	£52.00	9.2mm HSS 2-Flute Miniature Slot Drill	9.20	69	18	10
D0930BAM	£52.00	9.3mm HSS 2-Flute Miniature Slot Drill	9.30	69	18	10
D0940BAM	£52.00	9.4mm HSS 2-Flute Miniature Slot Drill	9.40	69	18	10
D0950BAM	£52.00	9.5mm HSS 2-Flute Miniature Slot Drill	9.50	69	18	10
D0952BAM	£52.00	3/8" HSS 2-Flute Miniature Slot Drill	3/8"	69	18	10
D0960BAM	£52.00	9.6mm HSS 2-Flute Miniature Slot Drill	9.60	69	18	10
D0970BAM	£52.00	9.7mm HSS 2-Flute Miniature Slot Drill	9.70	69	18	10
D0980BAM	£52.00	9.8mm HSS 2-Flute Miniature Slot Drill	9.80	69	20	10
D0990BAM	£52.00	9.9mm HSS 2-Flute Miniature Slot Drill	9.90	69	20	10
D1000BAM	£52.00	10mm HSS 2-Flute Miniature Slot Drill	10.00	69	20	10
D1010BAM	£73.15	10.1mm HSS 2-Flute Miniature Slot Drill	10.10	70	22	12
D1020BAM	£73.15	10.2mm HSS 2-Flute Miniature Slot Drill	10.20	70	22	12
D1030BAM	£73.15	10.3mm HSS 2-Flute Miniature Slot Drill	10.30	70	22	12
D1040BAM	£73.15	10.4mm HSS 2-Flute Miniature Slot Drill	10.40	70	22	12
D1050BAM	£73.15	10.5mm HSS 2-Flute Miniature Slot Drill	10.50	70	22	12
D1060BAM	£73.15	10.6mm HSS 2-Flute Miniature Slot Drill	10.60	70	22	12
D1070BAM	£73.15	10.7mm HSS 2-Flute Miniature Slot Drill	10.70	70	22	12
D1080BAM	£73.15	10.8mm HSS 2-Flute Miniature Slot Drill	10.80	70	22	12
D1090BAM	£73.15	10.9mm HSS 2-Flute Miniature Slot Drill	10.90	70	22	12

(Prices do not include VAT)

SLOT DRILLS & END MILLS

2 Flute Miniature Slot Drills

Supplied by Magafor

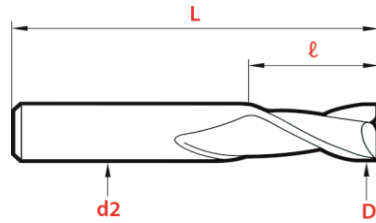

Code 500 HSS M35 5% Cob

Tolerance			
D	L	ℓ	d2
±0.01	±1	+1	h6

Product Code	Price	Description	D	L	ℓ	d2
D1100BAM	£73.15	11mm HSS 2-Flute Miniature Slot Drill	11.00	70	22	12
D1110BAM	£75.35	11.1mm HSS 2-Flute Miniature Slot Drill	11.10	79	26	12
D1120BAM	£75.35	11.2mm HSS 2-Flute Miniature Slot Drill	11.20	79	26	12
D1130BAM	£75.35	11.3mm HSS 2-Flute Miniature Slot Drill	11.30	79	26	12
D1140BAM	£75.35	11.4mm HSS 2-Flute Miniature Slot Drill	11.40	79	26	12
D1150BAM	£75.35	11.5mm HSS 2-Flute Miniature Slot Drill	11.50	79	26	12
D1160BAM	£75.35	11.6mm HSS 2-Flute Miniature Slot Drill	11.60	79	26	12
D1170BAM	£75.35	11.7mm HSS 2-Flute Miniature Slot Drill	11.70	79	26	12
D1180BAM	£75.35	11.8mm HSS 2-Flute Miniature Slot Drill	11.80	79	26	12
D1190BAM	£75.35	11.9mm HSS 2-Flute Miniature Slot Drill	11.90	79	26	12
D1200BAM	£75.35	12mm HSS 2-Flute Miniature Slot Drill	12.00	79	26	12
D1210BAM	£82.95	12.1mm HSS 2-Flute Miniature Slot Drill	12.10	83	26	12
D1220BAM	£82.95	12.2mm HSS 2-Flute Miniature Slot Drill	12.20	83	26	12
D1230BAM	£82.95	12.3mm HSS 2-Flute Miniature Slot Drill	12.30	83	26	12
D1240BAM	£82.95	12.4mm HSS 2-Flute Miniature Slot Drill	12.40	83	26	12
D1250BAM	£82.95	12.5mm HSS 2-Flute Miniature Slot Drill	12.50	83	26	12
D1260BAM	£82.95	12.6mm HSS 2-Flute Miniature Slot Drill	12.60	83	26	12
D1270BAM	£82.95	12.7mm HSS 2-Flute Miniature Slot Drill	12.70	83	26	12
D1280BAM	£82.95	12.8mm HSS 2-Flute Miniature Slot Drill	12.80	83	26	12
D1290BAM	£82.95	12.9mm HSS 2-Flute Miniature Slot Drill	12.90	83	26	12
D1300BAM	£82.95	13mm HSS 2-Flute Miniature Slot Drill	13.00	83	26	12
D1310BAM	£82.95	13.1mm HSS 2-Flute Miniature Slot Drill	13.10	83	26	12
D1320BAM	£82.95	13.2mm HSS 2-Flute Miniature Slot Drill	13.20	83	26	12
D1350BAM	£82.95	13.5mm HSS 2-Flute Miniature Slot Drill	13.50	83	26	12
D1400BAM	£82.95	14mm HSS 2-Flute Miniature Slot Drill	14.00	83	26	12

(Prices do not include VAT)

SLOT DRILLS & END MILLS

Extra Long 2 Flute Slot Drills

Supplied by Magafor

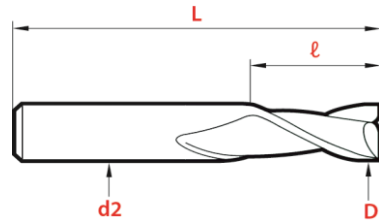
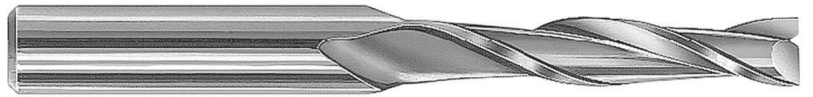

Code 510 HSS M35 5% Cob

Tolerance			
D	L	ℓ	d2
±0.01	±1	+1	h6

Product Code	Price	Description	D	L	ℓ	d2
D0100BBM	£84.65	1mm HSS Extra Long 2-Flute Slot Drill	1.0	40	8	4
D0150BBM	£76.30	1.5mm HSS Extra Long 2-Flute Slot Drill	1.5	40	10	4
D0200BBM	£72.50	2mm HSS Extra Long 2-Flute Slot Drill	2.0	47	15	4
D0250BBM	£72.50	2.5mm HSS Extra Long 2-Flute Slot Drill	2.5	51	18	4
D0300BBM	£76.30	3mm HSS Extra Long 2-Flute Slot Drill	3.0	61	25	5
D0400BBM	£76.30	4mm HSS Extra Long 2-Flute Slot Drill	4.0	70	30	6
D0500BBM	£76.30	5mm HSS Extra Long 2-Flute Slot Drill	5.0	73	35	6
D0600BBM	£76.30	6mm HSS Extra Long 2-Flute Slot Drill	6.0	80	35	8
D0800BBM	£91.00	8mm HSS Extra Long 2-Flute Slot Drill	8.0	83	40	8
D1000BBM	£90.06	10mm HSS Extra Long 2-Flute Slot Drill	10.0	95	45	10

(Prices do not include VAT)

SLOT DRILLS & END MILLS

2 Flute Ball Nose Miniature Slot Drills

Supplied by Magafor

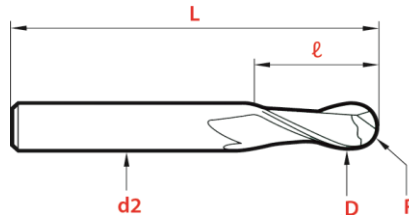
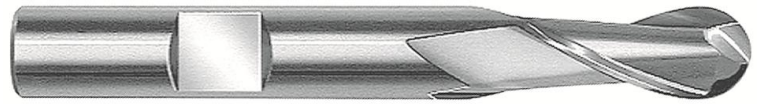

Range D	Tolerance			
	D	l	L	d2
0.4-0.6	-0.02	+0.20	-1	h6
0.7-2.0	-0.02	+0.30	-1	h6
≥2.5	-0.02	+0.50	-1	h6

Code 529 HSS M35 5% Cob

Product Code	Price	Description	D	L	l	d2	R
D0040BDM	£48.85	0.4mm HSS 2-Flute Ball Nose Miniature Slot Drill	0.4	37	1.0	3	0.20
D0050BDM	£48.85	0.5mm HSS 2-Flute Ball Nose Miniature Slot Drill	0.5	37	1.5	3	0.25
D0060BDM	£48.85	0.6mm HSS 2-Flute Ball Nose Miniature Slot Drill	0.6	37	1.5	3	0.30
D0080BDM	£48.85	0.8mm HSS 2-Flute Ball Nose Miniature Slot Drill	0.8	37	2	4	0.40
D0100BDM	£48.85	1mm HSS 2-Flute Ball Nose Miniature Slot Drill	1.0	37	3	4	0.50
D0120BDM	£48.85	1.2mm HSS 2-Flute Ball Nose Miniature Slot Drill	1.2	37	4	4	0.60
D0140BDM	£48.85	1.4mm HSS 2-Flute Ball Nose Miniature Slot Drill	1.4	37	4	4	0.70
D0150BDM	£48.85	1.5mm HSS 2-Flute Ball Nose Miniature Slot Drill	1.5	37	4	4	0.75
D0160BDM	£48.85	1.6mm HSS 2-Flute Ball Nose Miniature Slot Drill	1.6	37	4	4	0.80
D0180BDM	£48.85	1.8mm HSS 2-Flute Ball Nose Miniature Slot Drill	1.8	37	5	4	0.90
D0200BDM	£48.85	2mm HSS 2-Flute Ball Nose Miniature Slot Drill	2.0	52	7	6	1.00
D0250BDM	£48.85	2.5mm HSS 2-Flute Ball Nose Miniature Slot Drill	2.5	52	8	6	1.25
D0300BDM	£48.85	3mm HSS 2-Flute Ball Nose Miniature Slot Drill	3.0	52	8	6	1.50
D0400BDM	£47.60	4mm HSS 2-Flute Ball Nose Miniature Slot Drill	4.0	55	11	6	2.00
D0500BDM	£50.15	5mm HSS 2-Flute Ball Nose Miniature Slot Drill	5.0	57	13	6	2.50
D0600BDM	£51.40	6mm HSS 2-Flute Ball Nose Miniature Slot Drill	6.0	57	13	6	3.00
D0800BDM	£57.80	8mm HSS 2-Flute Ball Nose Miniature Slot Drill	8.0	69	19	10	4.00

(Prices do not include VAT)

SLOT DRILLS & END MILLS
3 Flute Intermediate Slot Drills
 Supplied by Leclerc

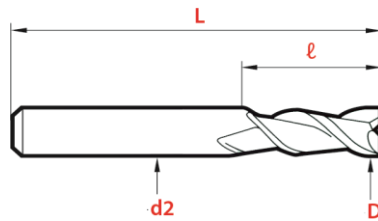

HSS M42 8% Cob

Tolerance			
D	L	ℓ	d2
-0.01	±1	+1	h6

Product Code	Price	Description	D	L	ℓ	d2
D0150BPL	£85.07	1.5mm HSS 3-Flute Intermediate Slot Drill	1.50	51	7	6
D0151BPL	£85.07	1.51mm HSS 3-Flute Intermediate Slot Drill	1.51	51	7	6
D0152BPL	£85.07	1.52mm HSS 3-Flute Intermediate Slot Drill	1.52	51	7	6
D0153BPL	£85.07	1.53mm HSS 3-Flute Intermediate Slot Drill	1.53	51	7	6
D0154BPL	£85.07	1.54mm HSS 3-Flute Intermediate Slot Drill	1.54	51	7	6
D0155BPL	£85.07	1.55mm HSS 3-Flute Intermediate Slot Drill	1.55	51	7	6
D0156BPL	£85.07	1.56mm HSS 3-Flute Intermediate Slot Drill	1.56	51	7	6
D0157BPL	£85.07	1.57mm HSS 3-Flute Intermediate Slot Drill	1.57	51	7	6
D0158BPL	£85.07	1.58mm HSS 3-Flute Intermediate Slot Drill	1.58	51	7	6
D0159BPL	£85.07	1.59mm HSS 3-Flute Intermediate Slot Drill	1.59	51	7	6
D0160BPL	£85.07	1.6mm HSS 3-Flute Intermediate Slot Drill	1.60	51	7	6
D0161BPL	£85.07	1.61mm HSS 3-Flute Intermediate Slot Drill	1.61	51	7	6
D0162BPL	£85.07	1.62mm HSS 3-Flute Intermediate Slot Drill	1.62	51	7	6
D0163BPL	£85.07	1.63mm HSS 3-Flute Intermediate Slot Drill	1.63	51	7	6
D0164BPL	£85.07	1.64mm HSS 3-Flute Intermediate Slot Drill	1.64	51	7	6
D0165BPL	£85.07	1.65mm HSS 3-Flute Intermediate Slot Drill	1.65	51	7	6
D0166BPL	£85.07	1.66mm HSS 3-Flute Intermediate Slot Drill	1.66	51	7	6
D0167BPL	£85.07	1.67mm HSS 3-Flute Intermediate Slot Drill	1.67	51	7	6
D0168BPL	£85.07	1.68mm HSS 3-Flute Intermediate Slot Drill	1.68	51	7	6
D0169BPL	£85.07	1.69mm HSS 3-Flute Intermediate Slot Drill	1.69	51	7	6
D0170BPL	£85.07	1.7mm HSS 3-Flute Intermediate Slot Drill	1.70	51	7	6
D0171BPL	£85.07	1.71mm HSS 3-Flute Intermediate Slot Drill	1.71	51	7	6
D0172BPL	£85.07	1.72mm HSS 3-Flute Intermediate Slot Drill	1.72	51	7	6
D0173BPL	£85.07	1.73mm HSS 3-Flute Intermediate Slot Drill	1.73	51	7	6
D0174BPL	£85.07	1.74mm HSS 3-Flute Intermediate Slot Drill	1.74	51	7	6
D0175BPL	£85.07	1.75mm HSS 3-Flute Intermediate Slot Drill	1.75	51	7	6
D0176BPL	£85.07	1.76mm HSS 3-Flute Intermediate Slot Drill	1.76	51	7	6
D0177BPL	£85.07	1.77mm HSS 3-Flute Intermediate Slot Drill	1.77	51	7	6
D0178BPL	£85.07	1.78mm HSS 3-Flute Intermediate Slot Drill	1.78	51	7	6
D0179BPL	£85.07	1.79mm HSS 3-Flute Intermediate Slot Drill	1.79	51	7	6
D0180BPL	£85.07	1.8mm HSS 3-Flute Intermediate Slot Drill	1.80	51	7	6
D0181BPL	£85.07	1.81mm HSS 3-Flute Intermediate Slot Drill	1.81	51	7	6
D0182BPL	£85.07	1.82mm HSS 3-Flute Intermediate Slot Drill	1.82	51	7	6
D0183BPL	£85.07	1.83mm HSS 3-Flute Intermediate Slot Drill	1.83	51	7	6
D0184BPL	£85.07	1.84mm HSS 3-Flute Intermediate Slot Drill	1.84	51	7	6
D0185BPL	£85.07	1.85mm HSS 3-Flute Intermediate Slot Drill	1.85	51	7	6
D0186BPL	£85.07	1.86mm HSS 3-Flute Intermediate Slot Drill	1.86	51	7	6
D0187BPL	£85.07	1.87mm HSS 3-Flute Intermediate Slot Drill	1.87	51	7	6
D0188BPL	£85.07	1.88mm HSS 3-Flute Intermediate Slot Drill	1.88	51	7	6
D0189BPL	£85.07	1.89mm HSS 3-Flute Intermediate Slot Drill	1.89	51	7	6
D0190BPL	£85.07	1.9mm HSS 3-Flute Intermediate Slot Drill	1.90	51	7	6
D0191BPL	£85.07	1.91mm HSS 3-Flute Intermediate Slot Drill	1.91	51	7	6
D0192BPL	£85.07	1.92mm HSS 3-Flute Intermediate Slot Drill	1.92	51	7	6
D0193BPL	£85.07	1.93mm HSS 3-Flute Intermediate Slot Drill	1.93	51	7	6

(Prices do not include VAT)

SLOT DRILLS & END MILLS
3 Flute Intermediate Slot Drills
 Supplied by Leclerc

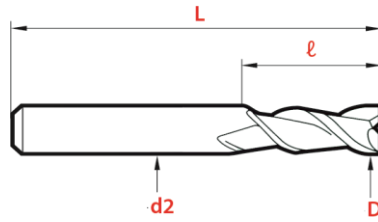

Tolerance			
D	L	ℓ	d2
-0.01	±1	+1	h6

HSS M42 8% Cob

Product Code	Price	Description	D	L	ℓ	d2
D0194BPL	£85.07	1.94mm HSS 3-Flute Intermediate Slot Drill	1.94	51	7	6
D0195BPL	£85.07	1.95mm HSS 3-Flute Intermediate Slot Drill	1.95	51	7	6
D0196BPL	£85.07	1.96mm HSS 3-Flute Intermediate Slot Drill	1.96	51	7	6
D0197BPL	£85.07	1.97mm HSS 3-Flute Intermediate Slot Drill	1.97	51	7	6
D0198BPL	£85.07	1.98mm HSS 3-Flute Intermediate Slot Drill	1.98	51	7	6
D0199BPL	£85.07	1.99mm HSS 3-Flute Intermediate Slot Drill	1.99	51	7	6
D0200BPL	£85.07	2mm HSS 3-Flute Intermediate Slot Drill	2.00	51	7	6
D0201BPL	£85.07	2.01mm HSS 3-Flute Intermediate Slot Drill	2.01	51	7	6
D0202BPL	£85.07	2.02mm HSS 3-Flute Intermediate Slot Drill	2.02	51	7	6
D0203BPL	£85.07	2.03mm HSS 3-Flute Intermediate Slot Drill	2.03	51	7	6
D0204BPL	£85.07	2.04mm HSS 3-Flute Intermediate Slot Drill	2.04	51	7	6
D0205BPL	£85.07	2.05mm HSS 3-Flute Intermediate Slot Drill	2.05	51	7	6
D0206BPL	£85.07	2.06mm HSS 3-Flute Intermediate Slot Drill	2.06	51	7	6
D0207BPL	£85.07	2.07mm HSS 3-Flute Intermediate Slot Drill	2.07	51	7	6
D0208BPL	£85.07	2.08mm HSS 3-Flute Intermediate Slot Drill	2.08	51	7	6
D0209BPL	£85.07	2.09mm HSS 3-Flute Intermediate Slot Drill	2.09	51	7	6
D0210BPL	£85.07	2.1mm HSS 3-Flute Intermediate Slot Drill	2.10	51	7	6
D0211BPL	£85.07	2.11mm HSS 3-Flute Intermediate Slot Drill	2.11	51	7	6
D0212BPL	£85.07	2.12mm HSS 3-Flute Intermediate Slot Drill	2.12	51	7	6
D0213BPL	£85.07	2.13mm HSS 3-Flute Intermediate Slot Drill	2.13	51	7	6
D0214BPL	£85.07	2.14mm HSS 3-Flute Intermediate Slot Drill	2.14	51	7	6
D0215BPL	£85.07	2.15mm HSS 3-Flute Intermediate Slot Drill	2.15	51	7	6
D0216BPL	£85.07	2.16mm HSS 3-Flute Intermediate Slot Drill	2.16	51	7	6
D0217BPL	£85.07	2.17mm HSS 3-Flute Intermediate Slot Drill	2.17	51	7	6
D0218BPL	£85.07	2.18mm HSS 3-Flute Intermediate Slot Drill	2.18	51	7	6
D0219BPL	£85.07	2.19mm HSS 3-Flute Intermediate Slot Drill	2.19	51	7	6
D0220BPL	£85.07	2.2mm HSS 3-Flute Intermediate Slot Drill	2.20	51	7	6
D0221BPL	£85.07	2.21mm HSS 3-Flute Intermediate Slot Drill	2.21	51	7	6
D0222BPL	£85.07	2.22mm HSS 3-Flute Intermediate Slot Drill	2.22	51	7	6
D0223BPL	£85.07	2.23mm HSS 3-Flute Intermediate Slot Drill	2.23	51	7	6
D0224BPL	£85.07	2.24mm HSS 3-Flute Intermediate Slot Drill	2.24	51	7	6
D0225BPL	£85.07	2.25mm HSS 3-Flute Intermediate Slot Drill	2.25	51	7	6
D0226BPL	£85.07	2.26mm HSS 3-Flute Intermediate Slot Drill	2.26	51	7	6
D0227BPL	£85.07	2.27mm HSS 3-Flute Intermediate Slot Drill	2.27	51	7	6
D0228BPL	£85.07	2.28mm HSS 3-Flute Intermediate Slot Drill	2.28	51	7	6
D0229BPL	£85.07	2.29mm HSS 3-Flute Intermediate Slot Drill	2.29	51	7	6
D0230BPL	£85.07	2.3mm HSS 3-Flute Intermediate Slot Drill	2.30	51	7	6
D0231BPL	£85.07	2.31mm HSS 3-Flute Intermediate Slot Drill	2.31	51	7	6
D0232BPL	£85.07	2.32mm HSS 3-Flute Intermediate Slot Drill	2.32	51	7	6
D0233BPL	£85.07	2.33mm HSS 3-Flute Intermediate Slot Drill	2.33	51	7	6
D0234BPL	£85.07	2.34mm HSS 3-Flute Intermediate Slot Drill	2.34	51	7	6
D0235BPL	£85.07	2.35mm HSS 3-Flute Intermediate Slot Drill	2.35	51	7	6
D0236BPL	£85.07	2.36mm HSS 3-Flute Intermediate Slot Drill	2.36	51	7	6
D0237BPL	£81.39	2.37mm HSS 3-Flute Intermediate Slot Drill	2.37	52	8	6

(Prices do not include VAT)

SLOT DRILLS & END MILLS
3 Flute Intermediate Slot Drills
 Supplied by Leclerc

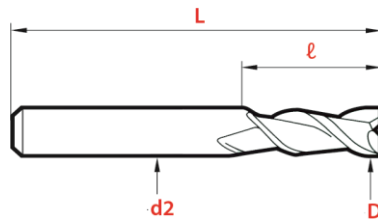

Tolerance			
D	L	ℓ	d2
-0.01	±1	+1	h6

HSS M42 8% Cob

Product Code	Price	Description	D	L	ℓ	d2
D0238BPL	£81.39	2.38mm HSS 3-Flute Intermediate Slot Drill	2.38	52	8	6
D0239BPL	£81.39	2.39mm HSS 3-Flute Intermediate Slot Drill	2.39	52	8	6
D0240BPL	£81.39	2.4mm HSS 3-Flute Intermediate Slot Drill	2.40	52	8	6
D0241BPL	£81.39	2.41mm HSS 3-Flute Intermediate Slot Drill	2.41	52	8	6
D0242BPL	£81.39	2.42mm HSS 3-Flute Intermediate Slot Drill	2.42	52	8	6
D0243BPL	£81.39	2.43mm HSS 3-Flute Intermediate Slot Drill	2.43	52	8	6
D0244BPL	£81.39	2.44mm HSS 3-Flute Intermediate Slot Drill	2.44	52	8	6
D0245BPL	£81.39	2.45mm HSS 3-Flute Intermediate Slot Drill	2.45	52	8	6
D0246BPL	£81.39	2.46mm HSS 3-Flute Intermediate Slot Drill	2.46	52	8	6
D0247BPL	£81.39	2.47mm HSS 3-Flute Intermediate Slot Drill	2.47	52	8	6
D0248BPL	£81.39	2.48mm HSS 3-Flute Intermediate Slot Drill	2.48	52	8	6
D0249BPL	£81.39	2.49mm HSS 3-Flute Intermediate Slot Drill	2.49	52	8	6
D0250BPL	£81.39	2.5mm HSS 3-Flute Intermediate Slot Drill	2.50	52	8	6
D0251BPL	£81.39	2.51mm HSS 3-Flute Intermediate Slot Drill	2.51	52	8	6
D0252BPL	£81.39	2.52mm HSS 3-Flute Intermediate Slot Drill	2.52	52	8	6
D0253BPL	£81.39	2.53mm HSS 3-Flute Intermediate Slot Drill	2.53	52	8	6
D0254BPL	£81.39	2.54mm HSS 3-Flute Intermediate Slot Drill	2.54	52	8	6
D0255BPL	£81.39	2.55mm HSS 3-Flute Intermediate Slot Drill	2.55	52	8	6
D0256BPL	£81.39	2.56mm HSS 3-Flute Intermediate Slot Drill	2.56	52	8	6
D0257BPL	£81.39	2.57mm HSS 3-Flute Intermediate Slot Drill	2.57	52	8	6
D0258BPL	£81.39	2.58mm HSS 3-Flute Intermediate Slot Drill	2.58	52	8	6
D0259BPL	£81.39	2.59mm HSS 3-Flute Intermediate Slot Drill	2.59	52	8	6
D0260BPL	£81.39	2.6mm HSS 3-Flute Intermediate Slot Drill	2.60	52	8	6
D0261BPL	£81.39	2.61mm HSS 3-Flute Intermediate Slot Drill	2.61	52	8	6
D0262BPL	£81.39	2.62mm HSS 3-Flute Intermediate Slot Drill	2.62	52	8	6
D0263BPL	£81.39	2.63mm HSS 3-Flute Intermediate Slot Drill	2.63	52	8	6
D0264BPL	£81.39	2.64mm HSS 3-Flute Intermediate Slot Drill	2.64	52	8	6
D0265BPL	£81.39	2.65mm HSS 3-Flute Intermediate Slot Drill	2.65	52	8	6
D0266BPL	£81.39	2.66mm HSS 3-Flute Intermediate Slot Drill	2.66	52	8	6
D0267BPL	£81.39	2.67mm HSS 3-Flute Intermediate Slot Drill	2.67	52	8	6
D0268BPL	£81.39	2.68mm HSS 3-Flute Intermediate Slot Drill	2.68	52	8	6
D0269BPL	£81.39	2.69mm HSS 3-Flute Intermediate Slot Drill	2.69	52	8	6
D0270BPL	£81.39	2.7mm HSS 3-Flute Intermediate Slot Drill	2.70	52	8	6
D0271BPL	£81.39	2.71mm HSS 3-Flute Intermediate Slot Drill	2.71	52	8	6
D0272BPL	£81.39	2.72mm HSS 3-Flute Intermediate Slot Drill	2.72	52	8	6
D0273BPL	£81.39	2.73mm HSS 3-Flute Intermediate Slot Drill	2.73	52	8	6
D0274BPL	£81.39	2.74mm HSS 3-Flute Intermediate Slot Drill	2.74	52	8	6
D0275BPL	£81.39	2.75mm HSS 3-Flute Intermediate Slot Drill	2.75	52	8	6
D0276BPL	£81.39	2.76mm HSS 3-Flute Intermediate Slot Drill	2.76	52	8	6
D0277BPL	£81.39	2.77mm HSS 3-Flute Intermediate Slot Drill	2.77	52	8	6
D0278BPL	£81.39	2.78mm HSS 3-Flute Intermediate Slot Drill	2.78	52	8	6
D0279BPL	£81.39	2.79mm HSS 3-Flute Intermediate Slot Drill	2.79	52	8	6
D0280BPL	£81.39	2.8mm HSS 3-Flute Intermediate Slot Drill	2.80	52	8	6
D0281BPL	£81.39	2.81mm HSS 3-Flute Intermediate Slot Drill	2.81	52	8	6

(Prices do not include VAT)

SLOT DRILLS & END MILLS

3 Flute Intermediate Slot Drills

Supplied by Leclerc

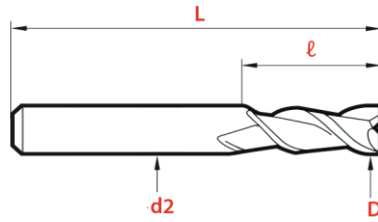

Tolerance			
D	L	ℓ	d2
-0.01	±1	+1	h6

HSS M42 8% Cob

Product Code	Price	Description	D	L	ℓ	d2
D0282BPL	£81.39	2.82mm HSS 3-Flute Intermediate Slot Drill	2.82	52	8	6
D0283BPL	£81.39	2.83mm HSS 3-Flute Intermediate Slot Drill	2.83	52	8	6
D0284BPL	£81.39	2.84mm HSS 3-Flute Intermediate Slot Drill	2.84	52	8	6
D0285BPL	£81.39	2.85mm HSS 3-Flute Intermediate Slot Drill	2.85	52	8	6
D0286BPL	£81.39	2.86mm HSS 3-Flute Intermediate Slot Drill	2.86	52	8	6
D0287BPL	£81.39	2.87mm HSS 3-Flute Intermediate Slot Drill	2.87	52	8	6
D0288BPL	£81.39	2.88mm HSS 3-Flute Intermediate Slot Drill	2.88	52	8	6
D0289BPL	£81.39	2.89mm HSS 3-Flute Intermediate Slot Drill	2.89	52	8	6
D0290BPL	£81.39	2.9mm HSS 3-Flute Intermediate Slot Drill	2.90	52	8	6
D0291BPL	£81.39	2.91mm HSS 3-Flute Intermediate Slot Drill	2.91	52	8	6
D0292BPL	£81.39	2.92mm HSS 3-Flute Intermediate Slot Drill	2.92	52	8	6
D0293BPL	£81.39	2.93mm HSS 3-Flute Intermediate Slot Drill	2.93	52	8	6
D0294BPL	£81.39	2.94mm HSS 3-Flute Intermediate Slot Drill	2.94	52	8	6
D0295BPL	£81.39	2.95mm HSS 3-Flute Intermediate Slot Drill	2.95	52	8	6
D0296BPL	£81.39	2.96mm HSS 3-Flute Intermediate Slot Drill	2.96	52	8	6
D0297BPL	£81.39	2.97mm HSS 3-Flute Intermediate Slot Drill	2.97	52	8	6
D0298BPL	£81.39	2.98mm HSS 3-Flute Intermediate Slot Drill	2.98	52	8	6
D0299BPL	£81.39	2.99mm HSS 3-Flute Intermediate Slot Drill	2.99	52	8	6
D0300BPL	£81.39	3mm HSS 3-Flute Intermediate Slot Drill	3.00	52	8	6
D0301BPL	£87.25	3.01mm HSS 3-Flute Intermediate Slot Drill	3.01	54	10	6
D0302BPL	£87.25	3.02mm HSS 3-Flute Intermediate Slot Drill	3.02	54	10	6
D0303BPL	£87.25	3.03mm HSS 3-Flute Intermediate Slot Drill	3.03	54	10	6
D0304BPL	£87.25	3.04mm HSS 3-Flute Intermediate Slot Drill	3.04	54	10	6
D0305BPL	£87.25	3.05mm HSS 3-Flute Intermediate Slot Drill	3.05	54	10	6
D0306BPL	£87.25	3.06mm HSS 3-Flute Intermediate Slot Drill	3.06	54	10	6
D0307BPL	£87.25	3.07mm HSS 3-Flute Intermediate Slot Drill	3.07	54	10	6
D0308BPL	£87.25	3.08mm HSS 3-Flute Intermediate Slot Drill	3.08	54	10	6
D0309BPL	£87.25	3.09mm HSS 3-Flute Intermediate Slot Drill	3.09	54	10	6
D0310BPL	£87.25	3.1mm HSS 3-Flute Intermediate Slot Drill	3.10	54	10	6
D0311BPL	£87.25	3.11mm HSS 3-Flute Intermediate Slot Drill	3.11	54	10	6
D0312BPL	£87.25	3.12mm HSS 3-Flute Intermediate Slot Drill	3.12	54	10	6
D0313BPL	£87.25	3.13mm HSS 3-Flute Intermediate Slot Drill	3.13	54	10	6
D0314BPL	£87.25	3.14mm HSS 3-Flute Intermediate Slot Drill	3.14	54	10	6
D0315BPL	£87.25	3.15mm HSS 3-Flute Intermediate Slot Drill	3.15	54	10	6
D0316BPL	£87.25	3.16mm HSS 3-Flute Intermediate Slot Drill	3.16	54	10	6
D0317BPL	£87.25	3.17mm HSS 3-Flute Intermediate Slot Drill	3.17	54	10	6
D0318BPL	£87.25	3.18mm HSS 3-Flute Intermediate Slot Drill	3.18	54	10	6
D0319BPL	£87.25	3.19mm HSS 3-Flute Intermediate Slot Drill	3.19	54	10	6
D0320BPL	£87.25	3.2mm HSS 3-Flute Intermediate Slot Drill	3.20	54	10	6
D0321BPL	£87.25	3.21mm HSS 3-Flute Intermediate Slot Drill	3.21	54	10	6
D0322BPL	£87.25	3.22mm HSS 3-Flute Intermediate Slot Drill	3.22	54	10	6
D0323BPL	£87.25	3.23mm HSS 3-Flute Intermediate Slot Drill	3.23	54	10	6
D0324BPL	£87.25	3.24mm HSS 3-Flute Intermediate Slot Drill	3.24	54	10	6
D0325BPL	£87.25	3.25mm HSS 3-Flute Intermediate Slot Drill	3.25	54	10	6

(Prices do not include VAT)

SLOT DRILLS & END MILLS

3 Flute Intermediate Slot Drills

Supplied by Leclerc

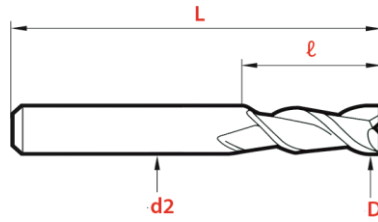

Tolerance			
D	L	ℓ	d2
-0.01	±1	+1	h6

HSS M42 8% Cob

Product Code	Price	Description	D	L	ℓ	d2
D0326BPL	£87.25	3.26mm HSS 3-Flute Intermediate Slot Drill	3.26	54	10	6
D0327BPL	£87.25	3.27mm HSS 3-Flute Intermediate Slot Drill	3.27	54	10	6
D0328BPL	£87.25	3.28mm HSS 3-Flute Intermediate Slot Drill	3.28	54	10	6
D0329BPL	£87.25	3.29mm HSS 3-Flute Intermediate Slot Drill	3.29	54	10	6
D0330BPL	£87.25	3.3mm HSS 3-Flute Intermediate Slot Drill	3.30	54	10	6
D0331BPL	£87.25	3.31mm HSS 3-Flute Intermediate Slot Drill	3.31	54	10	6
D0332BPL	£87.25	3.32mm HSS 3-Flute Intermediate Slot Drill	3.32	54	10	6
D0333BPL	£87.25	3.33mm HSS 3-Flute Intermediate Slot Drill	3.33	54	10	6
D0334BPL	£87.25	3.34mm HSS 3-Flute Intermediate Slot Drill	3.34	54	10	6
D0335BPL	£87.25	3.35mm HSS 3-Flute Intermediate Slot Drill	3.35	54	10	6
D0336BPL	£87.25	3.36mm HSS 3-Flute Intermediate Slot Drill	3.36	54	10	6
D0337BPL	£87.25	3.37mm HSS 3-Flute Intermediate Slot Drill	3.37	54	10	6
D0338BPL	£87.25	3.38mm HSS 3-Flute Intermediate Slot Drill	3.38	54	10	6
D0339BPL	£87.25	3.39mm HSS 3-Flute Intermediate Slot Drill	3.39	54	10	6
D0340BPL	£87.25	3.4mm HSS 3-Flute Intermediate Slot Drill	3.40	54	10	6
D0341BPL	£87.25	3.41mm HSS 3-Flute Intermediate Slot Drill	3.41	54	10	6
D0342BPL	£87.25	3.42mm HSS 3-Flute Intermediate Slot Drill	3.42	54	10	6
D0343BPL	£87.25	3.43mm HSS 3-Flute Intermediate Slot Drill	3.43	54	10	6
D0344BPL	£87.25	3.44mm HSS 3-Flute Intermediate Slot Drill	3.44	54	10	6
D0345BPL	£87.25	3.45mm HSS 3-Flute Intermediate Slot Drill	3.45	54	10	6
D0346BPL	£87.25	3.46mm HSS 3-Flute Intermediate Slot Drill	3.46	54	10	6
D0347BPL	£87.25	3.47mm HSS 3-Flute Intermediate Slot Drill	3.47	54	10	6
D0348BPL	£87.25	3.48mm HSS 3-Flute Intermediate Slot Drill	3.48	54	10	6
D0349BPL	£87.25	3.49mm HSS 3-Flute Intermediate Slot Drill	3.49	54	10	6
D0350BPL	£87.25	3.5mm HSS 3-Flute Intermediate Slot Drill	3.50	54	10	6
D0351BPL	£87.25	3.51mm HSS 3-Flute Intermediate Slot Drill	3.51	54	10	6
D0352BPL	£87.25	3.52mm HSS 3-Flute Intermediate Slot Drill	3.52	54	10	6
D0353BPL	£87.25	3.53mm HSS 3-Flute Intermediate Slot Drill	3.53	54	10	6
D0354BPL	£87.25	3.54mm HSS 3-Flute Intermediate Slot Drill	3.54	54	10	6
D0355BPL	£87.25	3.55mm HSS 3-Flute Intermediate Slot Drill	3.55	54	10	6
D0356BPL	£87.25	3.56mm HSS 3-Flute Intermediate Slot Drill	3.56	54	10	6
D0357BPL	£87.25	3.57mm HSS 3-Flute Intermediate Slot Drill	3.57	54	10	6
D0358BPL	£87.25	3.58mm HSS 3-Flute Intermediate Slot Drill	3.58	54	10	6
D0359BPL	£87.25	3.59mm HSS 3-Flute Intermediate Slot Drill	3.59	54	10	6
D0360BPL	£87.25	3.6mm HSS 3-Flute Intermediate Slot Drill	3.60	54	10	6
D0361BPL	£87.25	3.61mm HSS 3-Flute Intermediate Slot Drill	3.61	54	10	6
D0362BPL	£87.25	3.62mm HSS 3-Flute Intermediate Slot Drill	3.62	54	10	6
D0363BPL	£87.25	3.63mm HSS 3-Flute Intermediate Slot Drill	3.63	54	10	6
D0364BPL	£87.25	3.64mm HSS 3-Flute Intermediate Slot Drill	3.64	54	10	6
D0365BPL	£87.25	3.65mm HSS 3-Flute Intermediate Slot Drill	3.65	54	10	6
D0366BPL	£87.25	3.66mm HSS 3-Flute Intermediate Slot Drill	3.66	54	10	6
D0367BPL	£87.25	3.67mm HSS 3-Flute Intermediate Slot Drill	3.67	54	10	6
D0368BPL	£87.25	3.68mm HSS 3-Flute Intermediate Slot Drill	3.68	54	10	6
D0369BPL	£87.25	3.69mm HSS 3-Flute Intermediate Slot Drill	3.69	54	10	6

(Prices do not include VAT)

SLOT DRILLS & END MILLS
3 Flute Intermediate Slot Drills
 Supplied by Leclerc

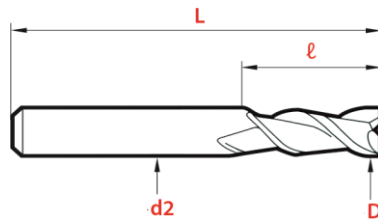

HSS M42 8% Cob

Tolerance			
D	L	ℓ	d2
-0.01	±1	+1	h6

Product Code	Price	Description	D	L	ℓ	d2
D0370BPL	£87.25	3.7mm HSS 3-Flute Intermediate Slot Drill	3.70	54	10	6
D0371BPL	£87.25	3.71mm HSS 3-Flute Intermediate Slot Drill	3.71	54	10	6
D0372BPL	£87.25	3.72mm HSS 3-Flute Intermediate Slot Drill	3.72	54	10	6
D0373BPL	£87.25	3.73mm HSS 3-Flute Intermediate Slot Drill	3.73	54	10	6
D0374BPL	£87.25	3.74mm HSS 3-Flute Intermediate Slot Drill	3.74	54	10	6
D0375BPL	£87.25	3.75mm HSS 3-Flute Intermediate Slot Drill	3.75	54	10	6
D0376BPL	£81.94	3.76mm HSS 3-Flute Intermediate Slot Drill	3.76	55	11	6
D0377BPL	£81.94	3.77mm HSS 3-Flute Intermediate Slot Drill	3.77	55	11	6
D0378BPL	£81.94	3.78mm HSS 3-Flute Intermediate Slot Drill	3.78	55	11	6
D0379BPL	£81.94	3.79mm HSS 3-Flute Intermediate Slot Drill	3.79	55	11	6
D0380BPL	£81.94	3.8mm HSS 3-Flute Intermediate Slot Drill	3.80	55	11	6
D0381BPL	£81.94	3.81mm HSS 3-Flute Intermediate Slot Drill	3.81	55	11	6
D0382BPL	£81.94	3.82mm HSS 3-Flute Intermediate Slot Drill	3.82	55	11	6
D0383BPL	£81.94	3.83mm HSS 3-Flute Intermediate Slot Drill	3.83	55	11	6
D0384BPL	£81.94	3.84mm HSS 3-Flute Intermediate Slot Drill	3.84	55	11	6
D0385BPL	£81.94	3.85mm HSS 3-Flute Intermediate Slot Drill	3.85	55	11	6
D0386BPL	£81.94	3.86mm HSS 3-Flute Intermediate Slot Drill	3.86	55	11	6
D0387BPL	£81.94	3.87mm HSS 3-Flute Intermediate Slot Drill	3.87	55	11	6
D0388BPL	£81.94	3.88mm HSS 3-Flute Intermediate Slot Drill	3.88	55	11	6
D0389BPL	£81.94	3.89mm HSS 3-Flute Intermediate Slot Drill	3.89	55	11	6
D0390BPL	£81.94	3.9mm HSS 3-Flute Intermediate Slot Drill	3.90	55	11	6
D0391BPL	£81.94	3.91mm HSS 3-Flute Intermediate Slot Drill	3.91	55	11	6
D0392BPL	£81.94	3.92mm HSS 3-Flute Intermediate Slot Drill	3.92	55	11	6
D0393BPL	£81.94	3.93mm HSS 3-Flute Intermediate Slot Drill	3.93	55	11	6
D0394BPL	£81.94	3.94mm HSS 3-Flute Intermediate Slot Drill	3.94	55	11	6
D0395BPL	£81.94	3.95mm HSS 3-Flute Intermediate Slot Drill	3.95	55	11	6
D0396BPL	£81.94	3.96mm HSS 3-Flute Intermediate Slot Drill	3.96	55	11	6
D0397BPL	£81.94	3.97mm HSS 3-Flute Intermediate Slot Drill	3.97	55	11	6
D0398BPL	£81.94	3.98mm HSS 3-Flute Intermediate Slot Drill	3.98	55	11	6
D0399BPL	£81.94	3.99mm HSS 3-Flute Intermediate Slot Drill	3.99	55	11	6
D0400BPL	£81.94	4mm HSS 3-Flute Intermediate Slot Drill	4.00	55	11	6
D0401BPL	£85.22	4.01mm HSS 3-Flute Intermediate Slot Drill	4.01	55	11	6
D0402BPL	£85.22	4.02mm HSS 3-Flute Intermediate Slot Drill	4.02	55	11	6
D0403BPL	£85.22	4.03mm HSS 3-Flute Intermediate Slot Drill	4.03	55	11	6
D0404BPL	£85.22	4.04mm HSS 3-Flute Intermediate Slot Drill	4.04	55	11	6
D0405BPL	£85.22	4.05mm HSS 3-Flute Intermediate Slot Drill	4.05	55	11	6
D0406BPL	£85.22	4.06mm HSS 3-Flute Intermediate Slot Drill	4.06	55	11	6
D0407BPL	£85.22	4.07mm HSS 3-Flute Intermediate Slot Drill	4.07	55	11	6
D0408BPL	£85.22	4.08mm HSS 3-Flute Intermediate Slot Drill	4.08	55	11	6
D0409BPL	£85.22	4.09mm HSS 3-Flute Intermediate Slot Drill	4.09	55	11	6
D0410BPL	£85.22	4.1mm HSS 3-Flute Intermediate Slot Drill	4.10	55	11	6
D0411BPL	£85.22	4.11mm HSS 3-Flute Intermediate Slot Drill	4.11	55	11	6
D0412BPL	£85.22	4.12mm HSS 3-Flute Intermediate Slot Drill	4.12	55	11	6
D0413BPL	£85.22	4.13mm HSS 3-Flute Intermediate Slot Drill	4.13	55	11	6

(Prices do not include VAT)

SLOT DRILLS & END MILLS
3 Flute Intermediate Slot Drills
 Supplied by Leclerc

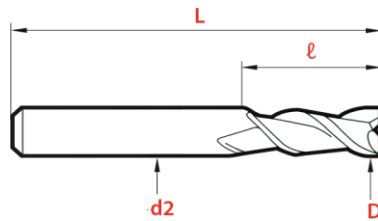

HSS M42 8% Cob

Tolerance			
D	L	ℓ	d2
-0.01	±1	+1	h6

Product Code	Price	Description	D	L	ℓ	d2
D0414BPL	£85.22	4.14mm HSS 3-Flute Intermediate Slot Drill	4.14	55	11	6
D0415BPL	£85.22	4.15mm HSS 3-Flute Intermediate Slot Drill	4.15	55	11	6
D0416BPL	£85.22	4.16mm HSS 3-Flute Intermediate Slot Drill	4.16	55	11	6
D0417BPL	£85.22	4.17mm HSS 3-Flute Intermediate Slot Drill	4.17	55	11	6
D0418BPL	£85.22	4.18mm HSS 3-Flute Intermediate Slot Drill	4.18	55	11	6
D0419BPL	£85.22	4.19mm HSS 3-Flute Intermediate Slot Drill	4.19	55	11	6
D0420BPL	£85.22	4.2mm HSS 3-Flute Intermediate Slot Drill	4.20	55	11	6
D0421BPL	£85.22	4.21mm HSS 3-Flute Intermediate Slot Drill	4.21	55	11	6
D0422BPL	£85.22	4.22mm HSS 3-Flute Intermediate Slot Drill	4.22	55	11	6
D0423BPL	£85.22	4.23mm HSS 3-Flute Intermediate Slot Drill	4.23	55	11	6
D0424BPL	£85.22	4.24mm HSS 3-Flute Intermediate Slot Drill	4.24	55	11	6
D0425BPL	£85.22	4.25mm HSS 3-Flute Intermediate Slot Drill	4.25	55	11	6
D0426BPL	£85.22	4.26mm HSS 3-Flute Intermediate Slot Drill	4.26	55	11	6
D0427BPL	£85.22	4.27mm HSS 3-Flute Intermediate Slot Drill	4.27	55	11	6
D0428BPL	£85.22	4.28mm HSS 3-Flute Intermediate Slot Drill	4.28	55	11	6
D0429BPL	£85.22	4.29mm HSS 3-Flute Intermediate Slot Drill	4.29	55	11	6
D0430BPL	£85.22	4.3mm HSS 3-Flute Intermediate Slot Drill	4.30	55	11	6
D0431BPL	£85.22	4.31mm HSS 3-Flute Intermediate Slot Drill	4.31	55	11	6
D0432BPL	£85.22	4.32mm HSS 3-Flute Intermediate Slot Drill	4.32	55	11	6
D0433BPL	£85.22	4.33mm HSS 3-Flute Intermediate Slot Drill	4.33	55	11	6
D0434BPL	£85.22	4.34mm HSS 3-Flute Intermediate Slot Drill	4.34	55	11	6
D0435BPL	£85.22	4.35mm HSS 3-Flute Intermediate Slot Drill	4.35	55	11	6
D0436BPL	£85.22	4.36mm HSS 3-Flute Intermediate Slot Drill	4.36	55	11	6
D0437BPL	£85.22	4.37mm HSS 3-Flute Intermediate Slot Drill	4.37	55	11	6
D0438BPL	£85.22	4.38mm HSS 3-Flute Intermediate Slot Drill	4.38	55	11	6
D0439BPL	£85.22	4.39mm HSS 3-Flute Intermediate Slot Drill	4.39	55	11	6
D0440BPL	£85.22	4.4mm HSS 3-Flute Intermediate Slot Drill	4.40	55	11	6
D0441BPL	£85.22	4.41mm HSS 3-Flute Intermediate Slot Drill	4.41	55	11	6
D0442BPL	£85.22	4.42mm HSS 3-Flute Intermediate Slot Drill	4.42	55	11	6
D0443BPL	£85.22	4.43mm HSS 3-Flute Intermediate Slot Drill	4.43	55	11	6
D0444BPL	£85.22	4.44mm HSS 3-Flute Intermediate Slot Drill	4.44	55	11	6
D0445BPL	£85.22	4.45mm HSS 3-Flute Intermediate Slot Drill	4.45	55	11	6
D0446BPL	£85.22	4.46mm HSS 3-Flute Intermediate Slot Drill	4.46	55	11	6
D0447BPL	£85.22	4.47mm HSS 3-Flute Intermediate Slot Drill	4.47	55	11	6
D0448BPL	£85.22	4.48mm HSS 3-Flute Intermediate Slot Drill	4.48	55	11	6
D0449BPL	£85.22	4.49mm HSS 3-Flute Intermediate Slot Drill	4.49	55	11	6
D0450BPL	£85.22	4.5mm HSS 3-Flute Intermediate Slot Drill	4.50	55	11	6
D0451BPL	£85.22	4.51mm HSS 3-Flute Intermediate Slot Drill	4.51	55	11	6
D0452BPL	£85.22	4.52mm HSS 3-Flute Intermediate Slot Drill	4.52	55	11	6
D0453BPL	£85.22	4.53mm HSS 3-Flute Intermediate Slot Drill	4.53	55	11	6
D0454BPL	£85.22	4.54mm HSS 3-Flute Intermediate Slot Drill	4.54	55	11	6
D0455BPL	£85.22	4.55mm HSS 3-Flute Intermediate Slot Drill	4.55	55	11	6
D0456BPL	£85.22	4.56mm HSS 3-Flute Intermediate Slot Drill	4.56	55	11	6
D0457BPL	£85.22	4.57mm HSS 3-Flute Intermediate Slot Drill	4.57	55	11	6

(Prices do not include VAT)

SLOT DRILLS & END MILLS
3 Flute Intermediate Slot Drills
 Supplied by Leclerc

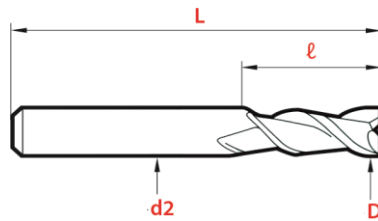

HSS M42 8% Cob

Tolerance			
D	L	ℓ	d2
-0.01	±1	+1	h6

Product Code	Price	Description	D	L	ℓ	d2
D0458BPL	£85.22	4.58mm HSS 3-Flute Intermediate Slot Drill	4.58	55	11	6
D0459BPL	£85.22	4.59mm HSS 3-Flute Intermediate Slot Drill	4.59	55	11	6
D0460BPL	£85.22	4.6mm HSS 3-Flute Intermediate Slot Drill	4.60	55	11	6
D0461BPL	£85.22	4.61mm HSS 3-Flute Intermediate Slot Drill	4.61	55	11	6
D0462BPL	£85.22	4.62mm HSS 3-Flute Intermediate Slot Drill	4.62	55	11	6
D0463BPL	£85.22	4.63mm HSS 3-Flute Intermediate Slot Drill	4.63	55	11	6
D0464BPL	£85.22	4.64mm HSS 3-Flute Intermediate Slot Drill	4.64	55	11	6
D0465BPL	£85.22	4.65mm HSS 3-Flute Intermediate Slot Drill	4.65	55	11	6
D0466BPL	£85.22	4.66mm HSS 3-Flute Intermediate Slot Drill	4.66	55	11	6
D0467BPL	£85.22	4.67mm HSS 3-Flute Intermediate Slot Drill	4.67	55	11	6
D0468BPL	£85.22	4.68mm HSS 3-Flute Intermediate Slot Drill	4.68	55	11	6
D0469BPL	£85.22	4.69mm HSS 3-Flute Intermediate Slot Drill	4.69	55	11	6
D0470BPL	£85.22	4.7mm HSS 3-Flute Intermediate Slot Drill	4.70	55	11	6
D0471BPL	£85.22	4.71mm HSS 3-Flute Intermediate Slot Drill	4.71	55	11	6
D0472BPL	£85.22	4.72mm HSS 3-Flute Intermediate Slot Drill	4.72	55	11	6
D0473BPL	£85.22	4.73mm HSS 3-Flute Intermediate Slot Drill	4.73	55	11	6
D0474BPL	£85.22	4.74mm HSS 3-Flute Intermediate Slot Drill	4.74	55	11	6
D0475BPL	£85.22	4.75mm HSS 3-Flute Intermediate Slot Drill	4.75	55	11	6
D0476BPL	£81.39	4.76mm HSS 3-Flute Intermediate Slot Drill	4.76	57	13	6
D0477BPL	£81.39	4.77mm HSS 3-Flute Intermediate Slot Drill	4.77	57	13	6
D0478BPL	£81.39	4.78mm HSS 3-Flute Intermediate Slot Drill	4.78	57	13	6
D0479BPL	£81.39	4.79mm HSS 3-Flute Intermediate Slot Drill	4.79	57	13	6
D0480BPL	£81.39	4.8mm HSS 3-Flute Intermediate Slot Drill	4.80	57	13	6
D0481BPL	£81.39	4.81mm HSS 3-Flute Intermediate Slot Drill	4.81	57	13	6
D0482BPL	£81.39	4.82mm HSS 3-Flute Intermediate Slot Drill	4.82	57	13	6
D0483BPL	£81.39	4.83mm HSS 3-Flute Intermediate Slot Drill	4.83	57	13	6
D0484BPL	£81.39	4.84mm HSS 3-Flute Intermediate Slot Drill	4.84	57	13	6
D0485BPL	£81.39	4.85mm HSS 3-Flute Intermediate Slot Drill	4.85	57	13	6
D0486BPL	£81.39	4.86mm HSS 3-Flute Intermediate Slot Drill	4.86	57	13	6
D0487BPL	£81.39	4.87mm HSS 3-Flute Intermediate Slot Drill	4.87	57	13	6
D0488BPL	£81.39	4.88mm HSS 3-Flute Intermediate Slot Drill	4.88	57	13	6
D0489BPL	£81.39	4.89mm HSS 3-Flute Intermediate Slot Drill	4.89	57	13	6
D0490BPL	£81.39	4.9mm HSS 3-Flute Intermediate Slot Drill	4.90	57	13	6
D0491BPL	£81.39	4.91mm HSS 3-Flute Intermediate Slot Drill	4.91	57	13	6
D0492BPL	£81.39	4.92mm HSS 3-Flute Intermediate Slot Drill	4.92	57	13	6
D0493BPL	£81.39	4.93mm HSS 3-Flute Intermediate Slot Drill	4.93	57	13	6
D0494BPL	£81.39	4.94mm HSS 3-Flute Intermediate Slot Drill	4.94	57	13	6
D0495BPL	£81.39	4.95mm HSS 3-Flute Intermediate Slot Drill	4.95	57	13	6
D0496BPL	£81.39	4.96mm HSS 3-Flute Intermediate Slot Drill	4.96	57	13	6
D0497BPL	£81.39	4.97mm HSS 3-Flute Intermediate Slot Drill	4.97	57	13	6
D0498BPL	£81.39	4.98mm HSS 3-Flute Intermediate Slot Drill	4.98	57	13	6
D0499BPL	£81.39	4.99mm HSS 3-Flute Intermediate Slot Drill	4.99	57	13	6
D0500BPL	£81.39	5mm HSS 3-Flute Intermediate Slot Drill	5.00	57	13	6
D0501BPL	£86.84	5.01mm HSS 3-Flute Intermediate Slot Drill	5.01	57	13	6

(Prices do not include VAT)

SLOT DRILLS & END MILLS
3 Flute Intermediate Slot Drills
 Supplied by Leclerc

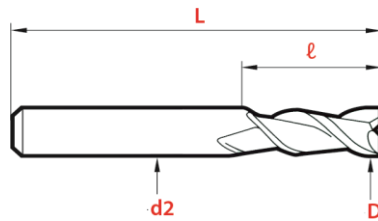

HSS M42 8% Cob

Tolerance			
D	L	ℓ	d2
-0.01	±1	+1	h6

Product Code	Price	Description	D	L	ℓ	d2
D0502BPL	£86.84	5.02mm HSS 3-Flute Intermediate Slot Drill	5.02	57	13	6
D0503BPL	£86.84	5.03mm HSS 3-Flute Intermediate Slot Drill	5.03	57	13	6
D0504BPL	£86.84	5.04mm HSS 3-Flute Intermediate Slot Drill	5.04	57	13	6
D0505BPL	£86.84	5.05mm HSS 3-Flute Intermediate Slot Drill	5.05	57	13	6
D0506BPL	£86.84	5.06mm HSS 3-Flute Intermediate Slot Drill	5.06	57	13	6
D0507BPL	£86.84	5.07mm HSS 3-Flute Intermediate Slot Drill	5.07	57	13	6
D0508BPL	£86.84	5.08mm HSS 3-Flute Intermediate Slot Drill	5.08	57	13	6
D0509BPL	£86.84	5.09mm HSS 3-Flute Intermediate Slot Drill	5.09	57	13	6
D0510BPL	£86.84	5.1mm HSS 3-Flute Intermediate Slot Drill	5.10	57	13	6
D0511BPL	£86.84	5.11mm HSS 3-Flute Intermediate Slot Drill	5.11	57	13	6
D0512BPL	£86.84	5.12mm HSS 3-Flute Intermediate Slot Drill	5.12	57	13	6
D0513BPL	£86.84	5.13mm HSS 3-Flute Intermediate Slot Drill	5.13	57	13	6
D0514BPL	£86.84	5.14mm HSS 3-Flute Intermediate Slot Drill	5.14	57	13	6
D0515BPL	£86.84	5.15mm HSS 3-Flute Intermediate Slot Drill	5.15	57	13	6
D0516BPL	£86.84	5.16mm HSS 3-Flute Intermediate Slot Drill	5.16	57	13	6
D0517BPL	£86.84	5.17mm HSS 3-Flute Intermediate Slot Drill	5.17	57	13	6
D0518BPL	£86.84	5.18mm HSS 3-Flute Intermediate Slot Drill	5.18	57	13	6
D0519BPL	£86.84	5.19mm HSS 3-Flute Intermediate Slot Drill	5.19	57	13	6
D0520BPL	£86.84	5.2mm HSS 3-Flute Intermediate Slot Drill	5.20	57	13	6
D0521BPL	£86.84	5.21mm HSS 3-Flute Intermediate Slot Drill	5.21	57	13	6
D0522BPL	£86.84	5.22mm HSS 3-Flute Intermediate Slot Drill	5.22	57	13	6
D0523BPL	£86.84	5.23mm HSS 3-Flute Intermediate Slot Drill	5.23	57	13	6
D0524BPL	£86.84	5.24mm HSS 3-Flute Intermediate Slot Drill	5.24	57	13	6
D0525BPL	£86.84	5.25mm HSS 3-Flute Intermediate Slot Drill	5.25	57	13	6
D0526BPL	£86.84	5.26mm HSS 3-Flute Intermediate Slot Drill	5.26	57	13	6
D0527BPL	£86.84	5.27mm HSS 3-Flute Intermediate Slot Drill	5.27	57	13	6
D0528BPL	£86.84	5.28mm HSS 3-Flute Intermediate Slot Drill	5.28	57	13	6
D0529BPL	£86.84	5.29mm HSS 3-Flute Intermediate Slot Drill	5.29	57	13	6
D0530BPL	£86.84	5.3mm HSS 3-Flute Intermediate Slot Drill	5.30	57	13	6
D0531BPL	£86.84	5.31mm HSS 3-Flute Intermediate Slot Drill	5.31	57	13	6
D0532BPL	£86.84	5.32mm HSS 3-Flute Intermediate Slot Drill	5.32	57	13	6
D0533BPL	£86.84	5.33mm HSS 3-Flute Intermediate Slot Drill	5.33	57	13	6
D0534BPL	£86.84	5.34mm HSS 3-Flute Intermediate Slot Drill	5.34	57	13	6
D0535BPL	£86.84	5.35mm HSS 3-Flute Intermediate Slot Drill	5.35	57	13	6
D0536BPL	£86.84	5.36mm HSS 3-Flute Intermediate Slot Drill	5.36	57	13	6
D0537BPL	£86.84	5.37mm HSS 3-Flute Intermediate Slot Drill	5.37	57	13	6
D0538BPL	£86.84	5.38mm HSS 3-Flute Intermediate Slot Drill	5.38	57	13	6
D0539BPL	£86.84	5.39mm HSS 3-Flute Intermediate Slot Drill	5.39	57	13	6
D0540BPL	£86.84	5.4mm HSS 3-Flute Intermediate Slot Drill	5.40	57	13	6
D0541BPL	£86.84	5.41mm HSS 3-Flute Intermediate Slot Drill	5.41	57	13	6
D0542BPL	£86.84	5.42mm HSS 3-Flute Intermediate Slot Drill	5.42	57	13	6
D0543BPL	£86.84	5.43mm HSS 3-Flute Intermediate Slot Drill	5.43	57	13	6
D0544BPL	£86.84	5.44mm HSS 3-Flute Intermediate Slot Drill	5.44	57	13	6
D0545BPL	£86.84	5.45mm HSS 3-Flute Intermediate Slot Drill	5.45	57	13	6

(Prices do not include VAT)

SLOT DRILLS & END MILLS
3 Flute Intermediate Slot Drills
 Supplied by Leclerc

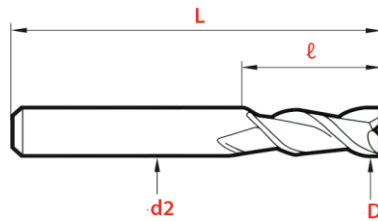

HSS M42 8% Cob

Tolerance			
D	L	ℓ	d2
-0.01	±1	+1	h6

Product Code	Price	Description	D	L	ℓ	d2
D0546BPL	£86.84	5.46mm HSS 3-Flute Intermediate Slot Drill	5.46	57	13	6
D0547BPL	£86.84	5.47mm HSS 3-Flute Intermediate Slot Drill	5.47	57	13	6
D0548BPL	£86.84	5.48mm HSS 3-Flute Intermediate Slot Drill	5.48	57	13	6
D0549BPL	£86.84	5.49mm HSS 3-Flute Intermediate Slot Drill	5.49	57	13	6
D0550BPL	£86.84	5.5mm HSS 3-Flute Intermediate Slot Drill	5.50	57	13	6
D0551BPL	£86.84	5.51mm HSS 3-Flute Intermediate Slot Drill	5.51	57	13	6
D0552BPL	£86.84	5.52mm HSS 3-Flute Intermediate Slot Drill	5.52	57	13	6
D0553BPL	£86.84	5.53mm HSS 3-Flute Intermediate Slot Drill	5.53	57	13	6
D0554BPL	£86.84	5.54mm HSS 3-Flute Intermediate Slot Drill	5.54	57	13	6
D0555BPL	£86.84	5.55mm HSS 3-Flute Intermediate Slot Drill	5.55	57	13	6
D0556BPL	£86.84	5.56mm HSS 3-Flute Intermediate Slot Drill	5.56	57	13	6
D0557BPL	£86.84	5.57mm HSS 3-Flute Intermediate Slot Drill	5.57	57	13	6
D0558BPL	£86.84	5.58mm HSS 3-Flute Intermediate Slot Drill	5.58	57	13	6
D0559BPL	£86.84	5.59mm HSS 3-Flute Intermediate Slot Drill	5.59	57	13	6
D0560BPL	£86.84	5.6mm HSS 3-Flute Intermediate Slot Drill	5.60	57	13	6
D0561BPL	£86.84	5.61mm HSS 3-Flute Intermediate Slot Drill	5.61	57	13	6
D0562BPL	£86.84	5.62mm HSS 3-Flute Intermediate Slot Drill	5.62	57	13	6
D0563BPL	£86.84	5.63mm HSS 3-Flute Intermediate Slot Drill	5.63	57	13	6
D0564BPL	£86.84	5.64mm HSS 3-Flute Intermediate Slot Drill	5.64	57	13	6
D0565BPL	£86.84	5.65mm HSS 3-Flute Intermediate Slot Drill	5.65	57	13	6
D0566BPL	£86.84	5.66mm HSS 3-Flute Intermediate Slot Drill	5.66	57	13	6
D0567BPL	£86.84	5.67mm HSS 3-Flute Intermediate Slot Drill	5.67	57	13	6
D0568BPL	£86.84	5.68mm HSS 3-Flute Intermediate Slot Drill	5.68	57	13	6
D0569BPL	£86.84	5.69mm HSS 3-Flute Intermediate Slot Drill	5.69	57	13	6
D0570BPL	£86.84	5.7mm HSS 3-Flute Intermediate Slot Drill	5.70	57	13	6
D0571BPL	£86.84	5.71mm HSS 3-Flute Intermediate Slot Drill	5.71	57	13	6
D0572BPL	£86.84	5.72mm HSS 3-Flute Intermediate Slot Drill	5.72	57	13	6
D0573BPL	£86.84	5.73mm HSS 3-Flute Intermediate Slot Drill	5.73	57	13	6
D0574BPL	£86.84	5.74mm HSS 3-Flute Intermediate Slot Drill	5.74	57	13	6
D0575BPL	£86.84	5.75mm HSS 3-Flute Intermediate Slot Drill	5.75	57	13	6
D0576BPL	£86.84	5.76mm HSS 3-Flute Intermediate Slot Drill	5.76	57	13	6
D0577BPL	£86.84	5.77mm HSS 3-Flute Intermediate Slot Drill	5.77	57	13	6
D0578BPL	£86.84	5.78mm HSS 3-Flute Intermediate Slot Drill	5.78	57	13	6
D0579BPL	£86.84	5.79mm HSS 3-Flute Intermediate Slot Drill	5.79	57	13	6
D0580BPL	£86.84	5.8mm HSS 3-Flute Intermediate Slot Drill	5.80	57	13	6
D0581BPL	£86.84	5.81mm HSS 3-Flute Intermediate Slot Drill	5.81	57	13	6
D0582BPL	£86.84	5.82mm HSS 3-Flute Intermediate Slot Drill	5.82	57	13	6
D0583BPL	£86.84	5.83mm HSS 3-Flute Intermediate Slot Drill	5.83	57	13	6
D0584BPL	£86.84	5.84mm HSS 3-Flute Intermediate Slot Drill	5.84	57	13	6
D0585BPL	£86.84	5.85mm HSS 3-Flute Intermediate Slot Drill	5.85	57	13	6
D0586BPL	£86.84	5.86mm HSS 3-Flute Intermediate Slot Drill	5.86	57	13	6
D0587BPL	£86.84	5.87mm HSS 3-Flute Intermediate Slot Drill	5.87	57	13	6
D0588BPL	£86.84	5.88mm HSS 3-Flute Intermediate Slot Drill	5.88	57	13	6
D0589BPL	£86.84	5.89mm HSS 3-Flute Intermediate Slot Drill	5.89	57	13	6

(Prices do not include VAT)

SLOT DRILLS & END MILLS
3 Flute Intermediate Slot Drills
Supplied by Leclerc

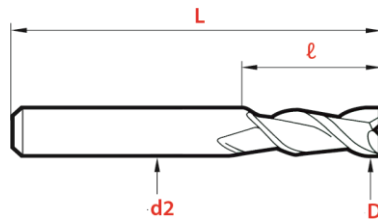

Tolerance			
D	L	ℓ	d2
-0.01	±1	+1	h6

HSS M42 8% Cob

Product Code	Price	Description	D	L	ℓ	d2
D0590BPL	£86.84	5.9mm HSS 3-Flute Intermediate Slot Drill	5.90	57	13	6
D0591BPL	£86.84	5.91mm HSS 3-Flute Intermediate Slot Drill	5.91	57	13	6
D0592BPL	£86.84	5.92mm HSS 3-Flute Intermediate Slot Drill	5.92	57	13	6
D0593BPL	£86.84	5.93mm HSS 3-Flute Intermediate Slot Drill	5.93	57	13	6
D0594BPL	£86.84	5.94mm HSS 3-Flute Intermediate Slot Drill	5.94	57	13	6
D0595BPL	£86.84	5.95mm HSS 3-Flute Intermediate Slot Drill	5.95	57	13	6
D0596BPL	£86.84	5.96mm HSS 3-Flute Intermediate Slot Drill	5.96	57	13	6
D0597BPL	£86.84	5.97mm HSS 3-Flute Intermediate Slot Drill	5.97	57	13	6
D0598BPL	£86.84	5.98mm HSS 3-Flute Intermediate Slot Drill	5.98	57	13	6
D0599BPL	£86.84	5.99mm HSS 3-Flute Intermediate Slot Drill	5.99	57	13	6
D0600BPL	£86.84	6mm HSS 3-Flute Intermediate Slot Drill	6.00	57	13	6
D0601BPL	£87.53	6.01mm HSS 3-Flute Intermediate Slot Drill	6.01	66	13	10
D0602BPL	£87.53	6.02mm HSS 3-Flute Intermediate Slot Drill	6.02	66	13	10
D0603BPL	£87.53	6.03mm HSS 3-Flute Intermediate Slot Drill	6.03	66	13	10
D0604BPL	£87.53	6.04mm HSS 3-Flute Intermediate Slot Drill	6.04	66	13	10
D0605BPL	£87.53	6.05mm HSS 3-Flute Intermediate Slot Drill	6.05	66	13	10
D0606BPL	£87.53	6.06mm HSS 3-Flute Intermediate Slot Drill	6.06	66	13	10
D0607BPL	£87.53	6.07mm HSS 3-Flute Intermediate Slot Drill	6.07	66	13	10
D0608BPL	£87.53	6.08mm HSS 3-Flute Intermediate Slot Drill	6.08	66	13	10
D0609BPL	£87.53	6.09mm HSS 3-Flute Intermediate Slot Drill	6.09	66	13	10
D0610BPL	£87.53	6.1mm HSS 3-Flute Intermediate Slot Drill	6.10	66	13	10
D0611BPL	£87.53	6.11mm HSS 3-Flute Intermediate Slot Drill	6.11	66	13	10
D0612BPL	£87.53	6.12mm HSS 3-Flute Intermediate Slot Drill	6.12	66	13	10
D0613BPL	£87.53	6.13mm HSS 3-Flute Intermediate Slot Drill	6.13	66	13	10
D0614BPL	£87.53	6.14mm HSS 3-Flute Intermediate Slot Drill	6.14	66	13	10
D0615BPL	£87.53	6.15mm HSS 3-Flute Intermediate Slot Drill	6.15	66	13	10
D0616BPL	£87.53	6.16mm HSS 3-Flute Intermediate Slot Drill	6.16	66	13	10
D0617BPL	£87.53	6.17mm HSS 3-Flute Intermediate Slot Drill	6.17	66	13	10
D0618BPL	£87.53	6.18mm HSS 3-Flute Intermediate Slot Drill	6.18	66	13	10
D0619BPL	£87.53	6.19mm HSS 3-Flute Intermediate Slot Drill	6.19	66	13	10
D0620BPL	£87.53	6.2mm HSS 3-Flute Intermediate Slot Drill	6.20	66	13	10
D0621BPL	£87.53	6.21mm HSS 3-Flute Intermediate Slot Drill	6.21	66	13	10
D0622BPL	£87.53	6.22mm HSS 3-Flute Intermediate Slot Drill	6.22	66	13	10
D0623BPL	£87.53	6.23mm HSS 3-Flute Intermediate Slot Drill	6.23	66	13	10
D0624BPL	£87.53	6.24mm HSS 3-Flute Intermediate Slot Drill	6.24	66	13	10
D0625BPL	£87.53	6.25mm HSS 3-Flute Intermediate Slot Drill	6.25	66	13	10
D0626BPL	£87.53	6.26mm HSS 3-Flute Intermediate Slot Drill	6.26	66	13	10
D0627BPL	£87.53	6.27mm HSS 3-Flute Intermediate Slot Drill	6.27	66	13	10
D0628BPL	£87.53	6.28mm HSS 3-Flute Intermediate Slot Drill	6.28	66	13	10
D0629BPL	£87.53	6.29mm HSS 3-Flute Intermediate Slot Drill	6.29	66	13	10
D0630BPL	£87.53	6.3mm HSS 3-Flute Intermediate Slot Drill	6.30	66	13	10
D0631BPL	£87.53	6.31mm HSS 3-Flute Intermediate Slot Drill	6.31	66	13	10
D0632BPL	£87.53	6.32mm HSS 3-Flute Intermediate Slot Drill	6.32	66	13	10
D0633BPL	£87.53	6.33mm HSS 3-Flute Intermediate Slot Drill	6.33	66	13	10

(Prices do not include VAT)

SLOT DRILLS & END MILLS
3 Flute Intermediate Slot Drills
Supplied by Leclerc

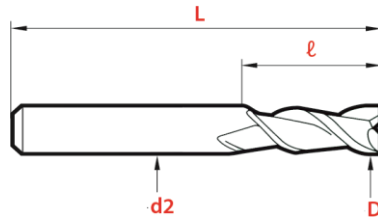

HSS M42 8% Cob

Tolerance			
D	L	ℓ	d2
-0.01	±1	+1	h6

Product Code	Price	Description	D	L	ℓ	d2
D0634BPL	£87.53	6.34mm HSS 3-Flute Intermediate Slot Drill	6.34	66	13	10
D0635BPL	£87.53	6.35mm HSS 3-Flute Intermediate Slot Drill	6.35	66	13	10
D0636BPL	£87.53	6.36mm HSS 3-Flute Intermediate Slot Drill	6.36	66	13	10
D0637BPL	£87.53	6.37mm HSS 3-Flute Intermediate Slot Drill	6.37	66	13	10
D0638BPL	£87.53	6.38mm HSS 3-Flute Intermediate Slot Drill	6.38	66	13	10
D0639BPL	£87.53	6.39mm HSS 3-Flute Intermediate Slot Drill	6.39	66	13	10
D0640BPL	£87.53	6.4mm HSS 3-Flute Intermediate Slot Drill	6.40	66	13	10
D0641BPL	£87.53	6.41mm HSS 3-Flute Intermediate Slot Drill	6.41	66	13	10
D0642BPL	£87.53	6.42mm HSS 3-Flute Intermediate Slot Drill	6.42	66	13	10
D0643BPL	£87.53	6.43mm HSS 3-Flute Intermediate Slot Drill	6.43	66	13	10
D0644BPL	£87.53	6.44mm HSS 3-Flute Intermediate Slot Drill	6.44	66	13	10
D0645BPL	£87.53	6.45mm HSS 3-Flute Intermediate Slot Drill	6.45	66	13	10
D0646BPL	£87.53	6.46mm HSS 3-Flute Intermediate Slot Drill	6.46	66	13	10
D0647BPL	£87.53	6.47mm HSS 3-Flute Intermediate Slot Drill	6.47	66	13	10
D0648BPL	£87.53	6.48mm HSS 3-Flute Intermediate Slot Drill	6.48	66	13	10
D0649BPL	£87.53	6.49mm HSS 3-Flute Intermediate Slot Drill	6.49	66	13	10
D0650BPL	£87.53	6.5mm HSS 3-Flute Intermediate Slot Drill	6.50	66	13	10
D0651BPL	£87.53	6.51mm HSS 3-Flute Intermediate Slot Drill	6.51	66	13	10
D0652BPL	£87.53	6.52mm HSS 3-Flute Intermediate Slot Drill	6.52	66	13	10
D0653BPL	£87.53	6.53mm HSS 3-Flute Intermediate Slot Drill	6.53	66	13	10
D0654BPL	£87.53	6.54mm HSS 3-Flute Intermediate Slot Drill	6.54	66	13	10
D0655BPL	£87.53	6.55mm HSS 3-Flute Intermediate Slot Drill	6.55	66	13	10
D0656BPL	£87.53	6.56mm HSS 3-Flute Intermediate Slot Drill	6.56	66	13	10
D0657BPL	£87.53	6.57mm HSS 3-Flute Intermediate Slot Drill	6.57	66	13	10
D0658BPL	£87.53	6.58mm HSS 3-Flute Intermediate Slot Drill	6.58	66	13	10
D0659BPL	£87.53	6.59mm HSS 3-Flute Intermediate Slot Drill	6.59	66	13	10
D0660BPL	£87.53	6.6mm HSS 3-Flute Intermediate Slot Drill	6.60	66	13	10
D0661BPL	£87.53	6.61mm HSS 3-Flute Intermediate Slot Drill	6.61	66	13	10
D0662BPL	£87.53	6.62mm HSS 3-Flute Intermediate Slot Drill	6.62	66	13	10
D0663BPL	£87.53	6.63mm HSS 3-Flute Intermediate Slot Drill	6.63	66	13	10
D0664BPL	£87.53	6.64mm HSS 3-Flute Intermediate Slot Drill	6.64	66	13	10
D0665BPL	£87.53	6.65mm HSS 3-Flute Intermediate Slot Drill	6.65	66	13	10
D0666BPL	£87.53	6.66mm HSS 3-Flute Intermediate Slot Drill	6.66	66	13	10
D0667BPL	£87.53	6.67mm HSS 3-Flute Intermediate Slot Drill	6.67	66	13	10
D0668BPL	£87.53	6.68mm HSS 3-Flute Intermediate Slot Drill	6.68	66	13	10
D0669BPL	£87.53	6.69mm HSS 3-Flute Intermediate Slot Drill	6.69	66	13	10
D0670BPL	£87.53	6.7mm HSS 3-Flute Intermediate Slot Drill	6.70	66	13	10
D0671BPL	£87.53	6.71mm HSS 3-Flute Intermediate Slot Drill	6.71	66	13	10
D0672BPL	£87.53	6.72mm HSS 3-Flute Intermediate Slot Drill	6.72	66	13	10
D0673BPL	£87.53	6.73mm HSS 3-Flute Intermediate Slot Drill	6.73	66	13	10
D0674BPL	£87.53	6.74mm HSS 3-Flute Intermediate Slot Drill	6.74	66	13	10
D0675BPL	£87.53	6.75mm HSS 3-Flute Intermediate Slot Drill	6.75	66	13	10
D0676BPL	£87.53	6.76mm HSS 3-Flute Intermediate Slot Drill	6.76	66	13	10
D0677BPL	£87.53	6.77mm HSS 3-Flute Intermediate Slot Drill	6.77	66	13	10

(Prices do not include VAT)

SLOT DRILLS & END MILLS

3 Flute Intermediate Slot Drills

Supplied by Leclerc

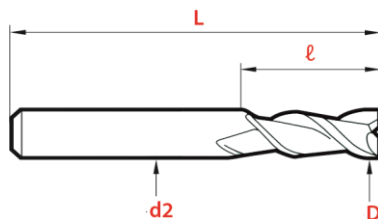

HSS M42 8% Cob

Tolerance			
D	L	ℓ	d2
-0.01	±1	+1	h6

Product Code	Price	Description	D	L	ℓ	d2
D0678BPL	£87.53	6.78mm HSS 3-Flute Intermediate Slot Drill	6.78	66	13	10
D0679BPL	£87.53	6.79mm HSS 3-Flute Intermediate Slot Drill	6.79	66	13	10
D0680BPL	£87.53	6.8mm HSS 3-Flute Intermediate Slot Drill	6.80	66	13	10
D0681BPL	£87.53	6.81mm HSS 3-Flute Intermediate Slot Drill	6.81	66	13	10
D0682BPL	£87.53	6.82mm HSS 3-Flute Intermediate Slot Drill	6.82	66	13	10
D0683BPL	£87.53	6.83mm HSS 3-Flute Intermediate Slot Drill	6.83	66	13	10
D0684BPL	£87.53	6.84mm HSS 3-Flute Intermediate Slot Drill	6.84	66	13	10
D0685BPL	£87.53	6.85mm HSS 3-Flute Intermediate Slot Drill	6.85	66	13	10
D0686BPL	£87.53	6.86mm HSS 3-Flute Intermediate Slot Drill	6.86	66	13	10
D0687BPL	£87.53	6.87mm HSS 3-Flute Intermediate Slot Drill	6.87	66	13	10
D0688BPL	£87.53	6.88mm HSS 3-Flute Intermediate Slot Drill	6.88	66	13	10
D0689BPL	£87.53	6.89mm HSS 3-Flute Intermediate Slot Drill	6.89	66	13	10
D0690BPL	£87.53	6.9mm HSS 3-Flute Intermediate Slot Drill	6.90	66	13	10
D0691BPL	£87.53	6.91mm HSS 3-Flute Intermediate Slot Drill	6.91	66	13	10
D0692BPL	£87.53	6.92mm HSS 3-Flute Intermediate Slot Drill	6.92	66	13	10
D0693BPL	£87.53	6.93mm HSS 3-Flute Intermediate Slot Drill	6.93	66	13	10
D0694BPL	£87.53	6.94mm HSS 3-Flute Intermediate Slot Drill	6.94	66	13	10
D0695BPL	£87.53	6.95mm HSS 3-Flute Intermediate Slot Drill	6.95	66	13	10
D0696BPL	£87.53	6.96mm HSS 3-Flute Intermediate Slot Drill	6.96	66	13	10
D0697BPL	£87.53	6.97mm HSS 3-Flute Intermediate Slot Drill	6.97	66	13	10
D0698BPL	£87.53	6.98mm HSS 3-Flute Intermediate Slot Drill	6.98	66	13	10
D0699BPL	£87.53	6.99mm HSS 3-Flute Intermediate Slot Drill	6.99	66	13	10
D0700BPL	£87.53	7mm HSS 3-Flute Intermediate Slot Drill	7.00	66	13	10
D0701BPL	£87.53	7.01mm HSS 3-Flute Intermediate Slot Drill	7.01	66	13	10
D0702BPL	£87.53	7.02mm HSS 3-Flute Intermediate Slot Drill	7.02	66	13	10
D0703BPL	£87.53	7.03mm HSS 3-Flute Intermediate Slot Drill	7.03	66	13	10
D0704BPL	£87.53	7.04mm HSS 3-Flute Intermediate Slot Drill	7.04	66	13	10
D0705BPL	£87.53	7.05mm HSS 3-Flute Intermediate Slot Drill	7.05	66	13	10
D0706BPL	£87.53	7.06mm HSS 3-Flute Intermediate Slot Drill	7.06	66	13	10
D0707BPL	£87.53	7.07mm HSS 3-Flute Intermediate Slot Drill	7.07	66	13	10
D0708BPL	£87.53	7.08mm HSS 3-Flute Intermediate Slot Drill	7.08	66	13	10
D0709BPL	£87.53	7.09mm HSS 3-Flute Intermediate Slot Drill	7.09	66	13	10
D0710BPL	£87.53	7.1mm HSS 3-Flute Intermediate Slot Drill	7.10	66	13	10
D0711BPL	£87.53	7.11mm HSS 3-Flute Intermediate Slot Drill	7.11	66	13	10
D0712BPL	£87.53	7.12mm HSS 3-Flute Intermediate Slot Drill	7.12	66	13	10
D0713BPL	£87.53	7.13mm HSS 3-Flute Intermediate Slot Drill	7.13	66	13	10
D0714BPL	£87.53	7.14mm HSS 3-Flute Intermediate Slot Drill	7.14	66	13	10
D0715BPL	£87.53	7.15mm HSS 3-Flute Intermediate Slot Drill	7.15	66	13	10
D0716BPL	£87.53	7.16mm HSS 3-Flute Intermediate Slot Drill	7.16	66	13	10
D0717BPL	£87.53	7.17mm HSS 3-Flute Intermediate Slot Drill	7.17	66	13	10
D0718BPL	£87.53	7.18mm HSS 3-Flute Intermediate Slot Drill	7.18	66	13	10
D0719BPL	£87.53	7.19mm HSS 3-Flute Intermediate Slot Drill	7.19	66	13	10
D0720BPL	£87.53	7.2mm HSS 3-Flute Intermediate Slot Drill	7.20	66	13	10
D0721BPL	£87.53	7.21mm HSS 3-Flute Intermediate Slot Drill	7.21	66	13	10

(Prices do not include VAT)

SLOT DRILLS & END MILLS

3 Flute Intermediate Slot Drills

Supplied by Leclerc

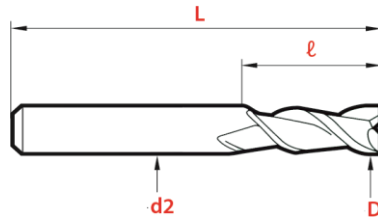

Tolerance			
D	L	ℓ	d2
-0.01	±1	+1	h6

HSS M42 8% Cob

Product Code	Price	Description	D	L	ℓ	d2
D0722BPL	£87.53	7.22mm HSS 3-Flute Intermediate Slot Drill	7.22	66	13	10
D0723BPL	£87.53	7.23mm HSS 3-Flute Intermediate Slot Drill	7.23	66	13	10
D0724BPL	£87.53	7.24mm HSS 3-Flute Intermediate Slot Drill	7.24	66	13	10
D0725BPL	£87.53	7.25mm HSS 3-Flute Intermediate Slot Drill	7.25	66	13	10
D0726BPL	£87.53	7.26mm HSS 3-Flute Intermediate Slot Drill	7.26	66	13	10
D0727BPL	£87.53	7.27mm HSS 3-Flute Intermediate Slot Drill	7.27	66	13	10
D0728BPL	£87.53	7.28mm HSS 3-Flute Intermediate Slot Drill	7.28	66	13	10
D0729BPL	£87.53	7.29mm HSS 3-Flute Intermediate Slot Drill	7.29	66	13	10
D0730BPL	£87.53	7.3mm HSS 3-Flute Intermediate Slot Drill	7.30	66	13	10
D0731BPL	£87.53	7.31mm HSS 3-Flute Intermediate Slot Drill	7.31	66	13	10
D0732BPL	£87.53	7.32mm HSS 3-Flute Intermediate Slot Drill	7.32	66	13	10
D0733BPL	£87.53	7.33mm HSS 3-Flute Intermediate Slot Drill	7.33	66	13	10
D0734BPL	£87.53	7.34mm HSS 3-Flute Intermediate Slot Drill	7.34	66	13	10
D0735BPL	£87.53	7.35mm HSS 3-Flute Intermediate Slot Drill	7.35	66	13	10
D0736BPL	£87.53	7.36mm HSS 3-Flute Intermediate Slot Drill	7.36	66	13	10
D0737BPL	£87.53	7.37mm HSS 3-Flute Intermediate Slot Drill	7.37	66	13	10
D0738BPL	£87.53	7.38mm HSS 3-Flute Intermediate Slot Drill	7.38	66	13	10
D0739BPL	£87.53	7.39mm HSS 3-Flute Intermediate Slot Drill	7.39	66	13	10
D0740BPL	£87.53	7.4mm HSS 3-Flute Intermediate Slot Drill	7.40	66	13	10
D0741BPL	£87.53	7.41mm HSS 3-Flute Intermediate Slot Drill	7.41	66	13	10
D0742BPL	£87.53	7.42mm HSS 3-Flute Intermediate Slot Drill	7.42	66	13	10
D0743BPL	£87.53	7.43mm HSS 3-Flute Intermediate Slot Drill	7.43	66	13	10
D0744BPL	£87.53	7.44mm HSS 3-Flute Intermediate Slot Drill	7.44	66	13	10
D0745BPL	£87.53	7.45mm HSS 3-Flute Intermediate Slot Drill	7.45	66	13	10
D0746BPL	£87.53	7.46mm HSS 3-Flute Intermediate Slot Drill	7.46	66	13	10
D0747BPL	£87.53	7.47mm HSS 3-Flute Intermediate Slot Drill	7.47	66	13	10
D0748BPL	£87.53	7.48mm HSS 3-Flute Intermediate Slot Drill	7.48	66	13	10
D0749BPL	£87.53	7.49mm HSS 3-Flute Intermediate Slot Drill	7.49	66	13	10
D0750BPL	£87.53	7.5mm HSS 3-Flute Intermediate Slot Drill	7.50	66	13	10
D0751BPL	£87.81	7.51mm HSS 3-Flute Intermediate Slot Drill	7.51	69	16	10
D0752BPL	£87.81	7.52mm HSS 3-Flute Intermediate Slot Drill	7.52	69	16	10
D0753BPL	£87.81	7.53mm HSS 3-Flute Intermediate Slot Drill	7.53	69	16	10
D0754BPL	£87.81	7.54mm HSS 3-Flute Intermediate Slot Drill	7.54	69	16	10
D0755BPL	£87.81	7.55mm HSS 3-Flute Intermediate Slot Drill	7.55	69	16	10
D0756BPL	£87.81	7.56mm HSS 3-Flute Intermediate Slot Drill	7.56	69	16	10
D0757BPL	£87.81	7.57mm HSS 3-Flute Intermediate Slot Drill	7.57	69	16	10
D0758BPL	£87.81	7.58mm HSS 3-Flute Intermediate Slot Drill	7.58	69	16	10
D0759BPL	£87.81	7.59mm HSS 3-Flute Intermediate Slot Drill	7.59	69	16	10
D0760BPL	£87.81	7.6mm HSS 3-Flute Intermediate Slot Drill	7.60	69	16	10
D0761BPL	£87.81	7.61mm HSS 3-Flute Intermediate Slot Drill	7.61	69	16	10
D0762BPL	£87.81	7.62mm HSS 3-Flute Intermediate Slot Drill	7.62	69	16	10
D0763BPL	£87.81	7.63mm HSS 3-Flute Intermediate Slot Drill	7.63	69	16	10
D0764BPL	£87.81	7.64mm HSS 3-Flute Intermediate Slot Drill	7.64	69	16	10
D0765BPL	£87.81	7.65mm HSS 3-Flute Intermediate Slot Drill	7.65	69	16	10

(Prices do not include VAT)

SLOT DRILLS & END MILLS
3 Flute Intermediate Slot Drills
Supplied by Leclerc

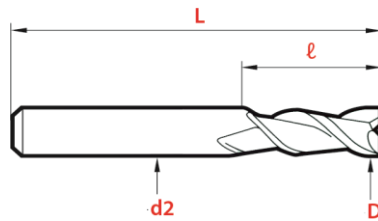

HSS M42 8% Cob

Tolerance			
D	L	ℓ	d2
-0.01	±1	+1	h6

Product Code	Price	Description	D	L	ℓ	d2
D0766BPL	£87.81	7.66mm HSS 3-Flute Intermediate Slot Drill	7.66	69	16	10
D0767BPL	£87.81	7.67mm HSS 3-Flute Intermediate Slot Drill	7.67	69	16	10
D0768BPL	£87.81	7.68mm HSS 3-Flute Intermediate Slot Drill	7.68	69	16	10
D0769BPL	£87.81	7.69mm HSS 3-Flute Intermediate Slot Drill	7.69	69	16	10
D0770BPL	£87.81	7.7mm HSS 3-Flute Intermediate Slot Drill	7.70	69	16	10
D0771BPL	£87.81	7.71mm HSS 3-Flute Intermediate Slot Drill	7.71	69	16	10
D0772BPL	£87.81	7.72mm HSS 3-Flute Intermediate Slot Drill	7.72	69	16	10
D0773BPL	£87.81	7.73mm HSS 3-Flute Intermediate Slot Drill	7.73	69	16	10
D0774BPL	£87.81	7.74mm HSS 3-Flute Intermediate Slot Drill	7.74	69	16	10
D0775BPL	£87.81	7.75mm HSS 3-Flute Intermediate Slot Drill	7.75	69	16	10
D0776BPL	£87.81	7.76mm HSS 3-Flute Intermediate Slot Drill	7.76	69	16	10
D0777BPL	£87.81	7.77mm HSS 3-Flute Intermediate Slot Drill	7.77	69	16	10
D0778BPL	£87.81	7.78mm HSS 3-Flute Intermediate Slot Drill	7.78	69	16	10
D0779BPL	£87.81	7.79mm HSS 3-Flute Intermediate Slot Drill	7.79	69	16	10
D0780BPL	£87.81	7.8mm HSS 3-Flute Intermediate Slot Drill	7.80	69	16	10
D0781BPL	£87.81	7.81mm HSS 3-Flute Intermediate Slot Drill	7.81	69	16	10
D0782BPL	£87.81	7.82mm HSS 3-Flute Intermediate Slot Drill	7.82	69	16	10
D0783BPL	£87.81	7.83mm HSS 3-Flute Intermediate Slot Drill	7.83	69	16	10
D0784BPL	£87.81	7.84mm HSS 3-Flute Intermediate Slot Drill	7.84	69	16	10
D0785BPL	£87.81	7.85mm HSS 3-Flute Intermediate Slot Drill	7.85	69	16	10
D0786BPL	£87.81	7.86mm HSS 3-Flute Intermediate Slot Drill	7.86	69	16	10
D0787BPL	£87.81	7.87mm HSS 3-Flute Intermediate Slot Drill	7.87	69	16	10
D0788BPL	£87.81	7.88mm HSS 3-Flute Intermediate Slot Drill	7.88	69	16	10
D0789BPL	£87.81	7.89mm HSS 3-Flute Intermediate Slot Drill	7.89	69	16	10
D0790BPL	£87.81	7.9mm HSS 3-Flute Intermediate Slot Drill	7.90	69	16	10
D0791BPL	£87.81	7.91mm HSS 3-Flute Intermediate Slot Drill	7.91	69	16	10
D0792BPL	£87.81	7.92mm HSS 3-Flute Intermediate Slot Drill	7.92	69	16	10
D0793BPL	£87.81	7.93mm HSS 3-Flute Intermediate Slot Drill	7.93	69	16	10
D0794BPL	£87.81	7.94mm HSS 3-Flute Intermediate Slot Drill	7.94	69	16	10
D0795BPL	£87.81	7.95mm HSS 3-Flute Intermediate Slot Drill	7.95	69	16	10
D0796BPL	£87.81	7.96mm HSS 3-Flute Intermediate Slot Drill	7.96	69	16	10
D0797BPL	£87.81	7.97mm HSS 3-Flute Intermediate Slot Drill	7.97	69	16	10
D0798BPL	£87.81	7.98mm HSS 3-Flute Intermediate Slot Drill	7.98	69	16	10
D0799BPL	£87.81	7.99mm HSS 3-Flute Intermediate Slot Drill	7.99	69	16	10
D0800BPL	£87.81	8mm HSS 3-Flute Intermediate Slot Drill	8.00	69	16	10
D0801BPL	£89.43	8.01mm HSS 3-Flute Intermediate Slot Drill	8.01	69	19	10
D0802BPL	£89.43	8.02mm HSS 3-Flute Intermediate Slot Drill	8.02	69	19	10
D0803BPL	£89.43	8.03mm HSS 3-Flute Intermediate Slot Drill	8.03	69	19	10
D0804BPL	£89.43	8.04mm HSS 3-Flute Intermediate Slot Drill	8.04	69	19	10
D0805BPL	£89.43	8.05mm HSS 3-Flute Intermediate Slot Drill	8.05	69	19	10
D0806BPL	£89.43	8.06mm HSS 3-Flute Intermediate Slot Drill	8.06	69	19	10
D0807BPL	£89.43	8.07mm HSS 3-Flute Intermediate Slot Drill	8.07	69	19	10
D0808BPL	£89.43	8.08mm HSS 3-Flute Intermediate Slot Drill	8.08	69	19	10
D0809BPL	£89.43	8.09mm HSS 3-Flute Intermediate Slot Drill	8.09	69	19	10

(Prices do not include VAT)

SLOT DRILLS & END MILLS

3 Flute Intermediate Slot Drills

Supplied by Leclerc

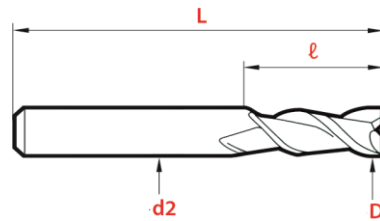

D	Tolerance			d2
	L	ℓ		
-0.01	±1	+1		h6

HSS M42 8% Cob

Product Code	Price	Description	D	L	ℓ	d2
D0810BPL	£89.43	8.1mm HSS 3-Flute Intermediate Slot Drill	8.10	69	19	10
D0811BPL	£89.43	8.11mm HSS 3-Flute Intermediate Slot Drill	8.11	69	19	10
D0812BPL	£89.43	8.12mm HSS 3-Flute Intermediate Slot Drill	8.12	69	19	10
D0813BPL	£89.43	8.13mm HSS 3-Flute Intermediate Slot Drill	8.13	69	19	10
D0814BPL	£89.43	8.14mm HSS 3-Flute Intermediate Slot Drill	8.14	69	19	10
D0815BPL	£89.43	8.15mm HSS 3-Flute Intermediate Slot Drill	8.15	69	19	10
D0816BPL	£89.43	8.16mm HSS 3-Flute Intermediate Slot Drill	8.16	69	19	10
D0817BPL	£89.43	8.17mm HSS 3-Flute Intermediate Slot Drill	8.17	69	19	10
D0818BPL	£89.43	8.18mm HSS 3-Flute Intermediate Slot Drill	8.18	69	19	10
D0819BPL	£89.43	8.19mm HSS 3-Flute Intermediate Slot Drill	8.19	69	19	10
D0820BPL	£89.43	8.2mm HSS 3-Flute Intermediate Slot Drill	8.20	69	19	10
D0821BPL	£89.43	8.21mm HSS 3-Flute Intermediate Slot Drill	8.21	69	19	10
D0822BPL	£89.43	8.22mm HSS 3-Flute Intermediate Slot Drill	8.22	69	19	10
D0823BPL	£89.43	8.23mm HSS 3-Flute Intermediate Slot Drill	8.23	69	19	10
D0824BPL	£89.43	8.24mm HSS 3-Flute Intermediate Slot Drill	8.24	69	19	10
D0825BPL	£89.43	8.25mm HSS 3-Flute Intermediate Slot Drill	8.25	69	19	10
D0826BPL	£89.43	8.26mm HSS 3-Flute Intermediate Slot Drill	8.26	69	19	10
D0827BPL	£89.43	8.27mm HSS 3-Flute Intermediate Slot Drill	8.27	69	19	10
D0828BPL	£89.43	8.28mm HSS 3-Flute Intermediate Slot Drill	8.28	69	19	10
D0829BPL	£89.43	8.29mm HSS 3-Flute Intermediate Slot Drill	8.29	69	19	10
D0830BPL	£89.43	8.3mm HSS 3-Flute Intermediate Slot Drill	8.30	69	19	10
D0831BPL	£89.43	8.31mm HSS 3-Flute Intermediate Slot Drill	8.31	69	19	10
D0832BPL	£89.43	8.32mm HSS 3-Flute Intermediate Slot Drill	8.32	69	19	10
D0833BPL	£89.43	8.33mm HSS 3-Flute Intermediate Slot Drill	8.33	69	19	10
D0834BPL	£89.43	8.34mm HSS 3-Flute Intermediate Slot Drill	8.34	69	19	10
D0835BPL	£89.43	8.35mm HSS 3-Flute Intermediate Slot Drill	8.35	69	19	10
D0836BPL	£89.43	8.36mm HSS 3-Flute Intermediate Slot Drill	8.36	69	19	10
D0837BPL	£89.43	8.37mm HSS 3-Flute Intermediate Slot Drill	8.37	69	19	10
D0838BPL	£89.43	8.38mm HSS 3-Flute Intermediate Slot Drill	8.38	69	19	10
D0839BPL	£89.43	8.39mm HSS 3-Flute Intermediate Slot Drill	8.39	69	19	10
D0840BPL	£89.43	8.4mm HSS 3-Flute Intermediate Slot Drill	8.40	69	19	10
D0841BPL	£89.43	8.41mm HSS 3-Flute Intermediate Slot Drill	8.41	69	19	10
D0842BPL	£89.43	8.42mm HSS 3-Flute Intermediate Slot Drill	8.42	69	19	10
D0843BPL	£89.43	8.43mm HSS 3-Flute Intermediate Slot Drill	8.43	69	19	10
D0844BPL	£89.43	8.44mm HSS 3-Flute Intermediate Slot Drill	8.44	69	19	10
D0845BPL	£89.43	8.45mm HSS 3-Flute Intermediate Slot Drill	8.45	69	19	10
D0846BPL	£89.43	8.46mm HSS 3-Flute Intermediate Slot Drill	8.46	69	19	10
D0847BPL	£89.43	8.47mm HSS 3-Flute Intermediate Slot Drill	8.47	69	19	10
D0848BPL	£89.43	8.48mm HSS 3-Flute Intermediate Slot Drill	8.48	69	19	10
D0849BPL	£89.43	8.49mm HSS 3-Flute Intermediate Slot Drill	8.49	69	19	10
D0850BPL	£89.43	8.5mm HSS 3-Flute Intermediate Slot Drill	8.50	69	19	10
D0851BPL	£89.43	8.51mm HSS 3-Flute Intermediate Slot Drill	8.51	69	19	10
D0852BPL	£89.43	8.52mm HSS 3-Flute Intermediate Slot Drill	8.52	69	19	10
D0853BPL	£89.43	8.53mm HSS 3-Flute Intermediate Slot Drill	8.53	69	19	10

(Prices do not include VAT)

SLOT DRILLS & END MILLS
3 Flute Intermediate Slot Drills
 Supplied by Leclerc

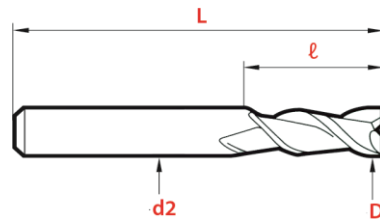

Tolerance			
D	L	ℓ	d2
-0.01	±1	+1	h6

HSS M42 8% Cob

Product Code	Price	Description	D	L	ℓ	d2
D0854BPL	£89.43	8.54mm HSS 3-Flute Intermediate Slot Drill	8.54	69	19	10
D0855BPL	£89.43	8.55mm HSS 3-Flute Intermediate Slot Drill	8.55	69	19	10
D0856BPL	£89.43	8.56mm HSS 3-Flute Intermediate Slot Drill	8.56	69	19	10
D0857BPL	£89.43	8.57mm HSS 3-Flute Intermediate Slot Drill	8.57	69	19	10
D0858BPL	£89.43	8.58mm HSS 3-Flute Intermediate Slot Drill	8.58	69	19	10
D0859BPL	£89.43	8.59mm HSS 3-Flute Intermediate Slot Drill	8.59	69	19	10
D0860BPL	£89.43	8.6mm HSS 3-Flute Intermediate Slot Drill	8.60	69	19	10
D0861BPL	£89.43	8.61mm HSS 3-Flute Intermediate Slot Drill	8.61	69	19	10
D0862BPL	£89.43	8.62mm HSS 3-Flute Intermediate Slot Drill	8.62	69	19	10
D0863BPL	£89.43	8.63mm HSS 3-Flute Intermediate Slot Drill	8.63	69	19	10
D0864BPL	£89.43	8.64mm HSS 3-Flute Intermediate Slot Drill	8.64	69	19	10
D0865BPL	£89.43	8.65mm HSS 3-Flute Intermediate Slot Drill	8.65	69	19	10
D0866BPL	£89.43	8.66mm HSS 3-Flute Intermediate Slot Drill	8.66	69	19	10
D0867BPL	£89.43	8.67mm HSS 3-Flute Intermediate Slot Drill	8.67	69	19	10
D0868BPL	£89.43	8.68mm HSS 3-Flute Intermediate Slot Drill	8.68	69	19	10
D0869BPL	£89.43	8.69mm HSS 3-Flute Intermediate Slot Drill	8.69	69	19	10
D0870BPL	£89.43	8.7mm HSS 3-Flute Intermediate Slot Drill	8.70	69	19	10
D0871BPL	£89.43	8.71mm HSS 3-Flute Intermediate Slot Drill	8.71	69	19	10
D0872BPL	£89.43	8.72mm HSS 3-Flute Intermediate Slot Drill	8.72	69	19	10
D0873BPL	£89.43	8.73mm HSS 3-Flute Intermediate Slot Drill	8.73	69	19	10
D0874BPL	£89.43	8.74mm HSS 3-Flute Intermediate Slot Drill	8.74	69	19	10
D0875BPL	£89.43	8.75mm HSS 3-Flute Intermediate Slot Drill	8.75	69	19	10
D0876BPL	£89.43	8.76mm HSS 3-Flute Intermediate Slot Drill	8.76	69	19	10
D0877BPL	£89.43	8.77mm HSS 3-Flute Intermediate Slot Drill	8.77	69	19	10
D0878BPL	£89.43	8.78mm HSS 3-Flute Intermediate Slot Drill	8.78	69	19	10
D0879BPL	£89.43	8.79mm HSS 3-Flute Intermediate Slot Drill	8.79	69	19	10
D0880BPL	£89.43	8.8mm HSS 3-Flute Intermediate Slot Drill	8.80	69	19	10
D0881BPL	£89.43	8.81mm HSS 3-Flute Intermediate Slot Drill	8.81	69	19	10
D0882BPL	£89.43	8.82mm HSS 3-Flute Intermediate Slot Drill	8.82	69	19	10
D0883BPL	£89.43	8.83mm HSS 3-Flute Intermediate Slot Drill	8.83	69	19	10
D0884BPL	£89.43	8.84mm HSS 3-Flute Intermediate Slot Drill	8.84	69	19	10
D0885BPL	£89.43	8.85mm HSS 3-Flute Intermediate Slot Drill	8.85	69	19	10
D0886BPL	£89.43	8.86mm HSS 3-Flute Intermediate Slot Drill	8.86	69	19	10
D0887BPL	£89.43	8.87mm HSS 3-Flute Intermediate Slot Drill	8.87	69	19	10
D0888BPL	£89.43	8.88mm HSS 3-Flute Intermediate Slot Drill	8.88	69	19	10
D0889BPL	£89.43	8.89mm HSS 3-Flute Intermediate Slot Drill	8.89	69	19	10
D0890BPL	£89.43	8.9mm HSS 3-Flute Intermediate Slot Drill	8.90	69	19	10
D0891BPL	£89.43	8.91mm HSS 3-Flute Intermediate Slot Drill	8.91	69	19	10
D0892BPL	£89.43	8.92mm HSS 3-Flute Intermediate Slot Drill	8.92	69	19	10
D0893BPL	£89.43	8.93mm HSS 3-Flute Intermediate Slot Drill	8.93	69	19	10
D0894BPL	£89.43	8.94mm HSS 3-Flute Intermediate Slot Drill	8.94	69	19	10
D0895BPL	£89.43	8.95mm HSS 3-Flute Intermediate Slot Drill	8.95	69	19	10
D0896BPL	£89.43	8.96mm HSS 3-Flute Intermediate Slot Drill	8.96	69	19	10
D0897BPL	£89.43	8.97mm HSS 3-Flute Intermediate Slot Drill	8.97	69	19	10

(Prices do not include VAT)

SLOT DRILLS & END MILLS
3 Flute Intermediate Slot Drills
 Supplied by Leclerc

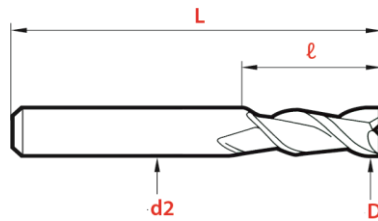

HSS M42 8% Cob

Tolerance			
D	L	ℓ	d2
-0.01	±1	+1	h6

Product Code	Price	Description	D	L	ℓ	d2
D0898BPL	£89.43	8.98mm HSS 3-Flute Intermediate Slot Drill	8.98	69	19	10
D0899BPL	£89.43	8.99mm HSS 3-Flute Intermediate Slot Drill	8.99	69	19	10
D0900BPL	£89.43	9mm HSS 3-Flute Intermediate Slot Drill	9.00	69	19	10
D0901BPL	£89.43	9.01mm HSS 3-Flute Intermediate Slot Drill	9.01	69	19	10
D0902BPL	£89.43	9.02mm HSS 3-Flute Intermediate Slot Drill	9.02	69	19	10
D0903BPL	£89.43	9.03mm HSS 3-Flute Intermediate Slot Drill	9.03	69	19	10
D0904BPL	£89.43	9.04mm HSS 3-Flute Intermediate Slot Drill	9.04	69	19	10
D0905BPL	£89.43	9.05mm HSS 3-Flute Intermediate Slot Drill	9.05	69	19	10
D0906BPL	£89.43	9.06mm HSS 3-Flute Intermediate Slot Drill	9.06	69	19	10
D0907BPL	£89.43	9.07mm HSS 3-Flute Intermediate Slot Drill	9.07	69	19	10
D0908BPL	£89.43	9.08mm HSS 3-Flute Intermediate Slot Drill	9.08	69	19	10
D0909BPL	£89.43	9.09mm HSS 3-Flute Intermediate Slot Drill	9.09	69	19	10
D0910BPL	£89.43	9.1mm HSS 3-Flute Intermediate Slot Drill	9.10	69	19	10
D0911BPL	£89.43	9.11mm HSS 3-Flute Intermediate Slot Drill	9.11	69	19	10
D0912BPL	£89.43	9.12mm HSS 3-Flute Intermediate Slot Drill	9.12	69	19	10
D0913BPL	£89.43	9.13mm HSS 3-Flute Intermediate Slot Drill	9.13	69	19	10
D0914BPL	£89.43	9.14mm HSS 3-Flute Intermediate Slot Drill	9.14	69	19	10
D0915BPL	£89.43	9.15mm HSS 3-Flute Intermediate Slot Drill	9.15	69	19	10
D0916BPL	£89.43	9.16mm HSS 3-Flute Intermediate Slot Drill	9.16	69	19	10
D0917BPL	£89.43	9.17mm HSS 3-Flute Intermediate Slot Drill	9.17	69	19	10
D0918BPL	£89.43	9.18mm HSS 3-Flute Intermediate Slot Drill	9.18	69	19	10
D0919BPL	£89.43	9.19mm HSS 3-Flute Intermediate Slot Drill	9.19	69	19	10
D0920BPL	£89.43	9.2mm HSS 3-Flute Intermediate Slot Drill	9.20	69	19	10
D0921BPL	£89.43	9.21mm HSS 3-Flute Intermediate Slot Drill	9.21	69	19	10
D0922BPL	£89.43	9.22mm HSS 3-Flute Intermediate Slot Drill	9.22	69	19	10
D0923BPL	£89.43	9.23mm HSS 3-Flute Intermediate Slot Drill	9.23	69	19	10
D0924BPL	£89.43	9.24mm HSS 3-Flute Intermediate Slot Drill	9.24	69	19	10
D0925BPL	£89.43	9.25mm HSS 3-Flute Intermediate Slot Drill	9.25	69	19	10
D0926BPL	£89.43	9.26mm HSS 3-Flute Intermediate Slot Drill	9.26	69	19	10
D0927BPL	£89.43	9.27mm HSS 3-Flute Intermediate Slot Drill	9.27	69	19	10
D0928BPL	£89.43	9.28mm HSS 3-Flute Intermediate Slot Drill	9.28	69	19	10
D0929BPL	£89.43	9.29mm HSS 3-Flute Intermediate Slot Drill	9.29	69	19	10
D0930BPL	£89.43	9.3mm HSS 3-Flute Intermediate Slot Drill	9.30	69	19	10
D0931BPL	£89.43	9.31mm HSS 3-Flute Intermediate Slot Drill	9.31	69	19	10
D0932BPL	£89.43	9.32mm HSS 3-Flute Intermediate Slot Drill	9.32	69	19	10
D0933BPL	£89.43	9.33mm HSS 3-Flute Intermediate Slot Drill	9.33	69	19	10
D0934BPL	£89.43	9.34mm HSS 3-Flute Intermediate Slot Drill	9.34	69	19	10
D0935BPL	£89.43	9.35mm HSS 3-Flute Intermediate Slot Drill	9.35	69	19	10
D0936BPL	£89.43	9.36mm HSS 3-Flute Intermediate Slot Drill	9.36	69	19	10
D0937BPL	£89.43	9.37mm HSS 3-Flute Intermediate Slot Drill	9.37	69	19	10
D0938BPL	£89.43	9.38mm HSS 3-Flute Intermediate Slot Drill	9.38	69	19	10
D0939BPL	£89.43	9.39mm HSS 3-Flute Intermediate Slot Drill	9.39	69	19	10
D0940BPL	£89.43	9.4mm HSS 3-Flute Intermediate Slot Drill	9.40	69	19	10
D0941BPL	£89.43	9.41mm HSS 3-Flute Intermediate Slot Drill	9.41	69	19	10

(Prices do not include VAT)

SLOT DRILLS & END MILLS

3 Flute Intermediate Slot Drills

Supplied by Leclerc

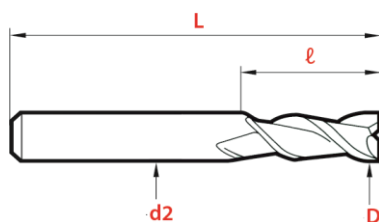

HSS M42 8% Cob

Tolerance			
D	L	ℓ	d2
-0.01	±1	+1	h6

Product Code	Price	Description	D	L	ℓ	d2
D0942BPL	£89.43	9.42mm HSS 3-Flute Intermediate Slot Drill	9.42	69	19	10
D0943BPL	£89.43	9.43mm HSS 3-Flute Intermediate Slot Drill	9.43	69	19	10
D0944BPL	£89.43	9.44mm HSS 3-Flute Intermediate Slot Drill	9.44	69	19	10
D0945BPL	£89.43	9.45mm HSS 3-Flute Intermediate Slot Drill	9.45	69	19	10
D0946BPL	£89.43	9.46mm HSS 3-Flute Intermediate Slot Drill	9.46	69	19	10
D0947BPL	£89.43	9.47mm HSS 3-Flute Intermediate Slot Drill	9.47	69	19	10
D0948BPL	£89.43	9.48mm HSS 3-Flute Intermediate Slot Drill	9.48	69	19	10
D0949BPL	£89.43	9.49mm HSS 3-Flute Intermediate Slot Drill	9.49	69	19	10
D0950BPL	£89.43	9.5mm HSS 3-Flute Intermediate Slot Drill	9.50	69	19	10
D0951BPL	£85.76	9.51mm HSS 3-Flute Intermediate Slot Drill	9.51	72	22	10
D0952BPL	£85.76	9.52mm HSS 3-Flute Intermediate Slot Drill	9.52	72	22	10
D0953BPL	£85.76	9.53mm HSS 3-Flute Intermediate Slot Drill	9.53	72	22	10
D0954BPL	£85.76	9.54mm HSS 3-Flute Intermediate Slot Drill	9.54	72	22	10
D0955BPL	£85.76	9.55mm HSS 3-Flute Intermediate Slot Drill	9.55	72	22	10
D0956BPL	£85.76	9.56mm HSS 3-Flute Intermediate Slot Drill	9.56	72	22	10
D0957BPL	£85.76	9.57mm HSS 3-Flute Intermediate Slot Drill	9.57	72	22	10
D0958BPL	£85.76	9.58mm HSS 3-Flute Intermediate Slot Drill	9.58	72	22	10
D0959BPL	£85.76	9.59mm HSS 3-Flute Intermediate Slot Drill	9.59	72	22	10
D0960BPL	£85.76	9.6mm HSS 3-Flute Intermediate Slot Drill	9.60	72	22	10
D0961BPL	£85.76	9.61mm HSS 3-Flute Intermediate Slot Drill	9.61	72	22	10
D0962BPL	£85.76	9.62mm HSS 3-Flute Intermediate Slot Drill	9.62	72	22	10
D0963BPL	£85.76	9.63mm HSS 3-Flute Intermediate Slot Drill	9.63	72	22	10
D0964BPL	£85.76	9.64mm HSS 3-Flute Intermediate Slot Drill	9.64	72	22	10
D0965BPL	£85.76	9.65mm HSS 3-Flute Intermediate Slot Drill	9.65	72	22	10
D0966BPL	£85.76	9.66mm HSS 3-Flute Intermediate Slot Drill	9.66	72	22	10
D0967BPL	£85.76	9.67mm HSS 3-Flute Intermediate Slot Drill	9.67	72	22	10
D0968BPL	£85.76	9.68mm HSS 3-Flute Intermediate Slot Drill	9.68	72	22	10
D0969BPL	£85.76	9.69mm HSS 3-Flute Intermediate Slot Drill	9.69	72	22	10
D0970BPL	£85.76	9.7mm HSS 3-Flute Intermediate Slot Drill	9.70	72	22	10
D0971BPL	£85.76	9.71mm HSS 3-Flute Intermediate Slot Drill	9.71	72	22	10
D0972BPL	£85.76	9.72mm HSS 3-Flute Intermediate Slot Drill	9.72	72	22	10
D0973BPL	£85.76	9.73mm HSS 3-Flute Intermediate Slot Drill	9.73	72	22	10
D0974BPL	£85.76	9.74mm HSS 3-Flute Intermediate Slot Drill	9.74	72	22	10
D0975BPL	£85.76	9.75mm HSS 3-Flute Intermediate Slot Drill	9.75	72	22	10
D0976BPL	£85.76	9.76mm HSS 3-Flute Intermediate Slot Drill	9.76	72	22	10
D0977BPL	£85.76	9.77mm HSS 3-Flute Intermediate Slot Drill	9.77	72	22	10
D0978BPL	£85.76	9.78mm HSS 3-Flute Intermediate Slot Drill	9.78	72	22	10
D0979BPL	£85.76	9.79mm HSS 3-Flute Intermediate Slot Drill	9.79	72	22	10
D0980BPL	£85.76	9.8mm HSS 3-Flute Intermediate Slot Drill	9.80	72	22	10
D0981BPL	£85.76	9.81mm HSS 3-Flute Intermediate Slot Drill	9.81	72	22	10
D0982BPL	£85.76	9.82mm HSS 3-Flute Intermediate Slot Drill	9.82	72	22	10
D0983BPL	£85.76	9.83mm HSS 3-Flute Intermediate Slot Drill	9.83	72	22	10
D0984BPL	£85.76	9.84mm HSS 3-Flute Intermediate Slot Drill	9.84	72	22	10
D0985BPL	£85.76	9.85mm HSS 3-Flute Intermediate Slot Drill	9.85	72	22	10

(Prices do not include VAT)

SLOT DRILLS & END MILLS

3 Flute Intermediate Slot Drills

Supplied by Leclerc

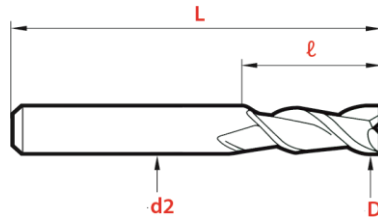

Tolerance			
D	L	ℓ	d2
-0.01	±1	+1	h6

HSS M42 8% Cob

Product Code	Price	Description	D	L	ℓ	d2
D0986BPL	£85.76	9.86mm HSS 3-Flute Intermediate Slot Drill	9.86	72	22	10
D0987BPL	£85.76	9.87mm HSS 3-Flute Intermediate Slot Drill	9.87	72	22	10
D0988BPL	£85.76	9.88mm HSS 3-Flute Intermediate Slot Drill	9.88	72	22	10
D0989BPL	£85.76	9.89mm HSS 3-Flute Intermediate Slot Drill	9.89	72	22	10
D0990BPL	£85.76	9.9mm HSS 3-Flute Intermediate Slot Drill	9.90	72	22	10
D0991BPL	£85.76	9.91mm HSS 3-Flute Intermediate Slot Drill	9.91	72	22	10
D0992BPL	£85.76	9.92mm HSS 3-Flute Intermediate Slot Drill	9.92	72	22	10
D0993BPL	£85.76	9.93mm HSS 3-Flute Intermediate Slot Drill	9.93	72	22	10
D0994BPL	£85.76	9.94mm HSS 3-Flute Intermediate Slot Drill	9.94	72	22	10
D0995BPL	£85.76	9.95mm HSS 3-Flute Intermediate Slot Drill	9.95	72	22	10
D0996BPL	£85.76	9.96mm HSS 3-Flute Intermediate Slot Drill	9.96	72	22	10
D0997BPL	£85.76	9.97mm HSS 3-Flute Intermediate Slot Drill	9.97	72	22	10
D0998BPL	£85.76	9.98mm HSS 3-Flute Intermediate Slot Drill	9.98	72	22	10
D0999BPL	£85.76	9.99mm HSS 3-Flute Intermediate Slot Drill	9.99	72	22	10
D1000BPL	£85.76	10mm HSS 3-Flute Intermediate Slot Drill	10.00	72	22	10
D1001BPL	£96.93	10.01mm HSS 3-Flute Intermediate Slot Drill	10.01	79	22	12
D1002BPL	£96.93	10.02mm HSS 3-Flute Intermediate Slot Drill	10.02	79	22	12
D1003BPL	£96.93	10.03mm HSS 3-Flute Intermediate Slot Drill	10.03	79	22	12
D1004BPL	£96.93	10.04mm HSS 3-Flute Intermediate Slot Drill	10.04	79	22	12
D1005BPL	£96.93	10.05mm HSS 3-Flute Intermediate Slot Drill	10.05	79	22	12
D1006BPL	£96.93	10.06mm HSS 3-Flute Intermediate Slot Drill	10.06	79	22	12
D1007BPL	£96.93	10.07mm HSS 3-Flute Intermediate Slot Drill	10.07	79	22	12
D1008BPL	£96.93	10.08mm HSS 3-Flute Intermediate Slot Drill	10.08	79	22	12
D1009BPL	£96.93	10.09mm HSS 3-Flute Intermediate Slot Drill	10.09	79	22	12
D1010BPL	£96.93	10.1mm HSS 3-Flute Intermediate Slot Drill	10.10	79	22	12
D1011BPL	£96.93	10.11mm HSS 3-Flute Intermediate Slot Drill	10.11	79	22	12
D1012BPL	£96.93	10.12mm HSS 3-Flute Intermediate Slot Drill	10.12	79	22	12
D1013BPL	£96.93	10.13mm HSS 3-Flute Intermediate Slot Drill	10.13	79	22	12
D1014BPL	£96.93	10.14mm HSS 3-Flute Intermediate Slot Drill	10.14	79	22	12
D1015BPL	£96.93	10.15mm HSS 3-Flute Intermediate Slot Drill	10.15	79	22	12
D1016BPL	£96.93	10.16mm HSS 3-Flute Intermediate Slot Drill	10.16	79	22	12
D1017BPL	£96.93	10.17mm HSS 3-Flute Intermediate Slot Drill	10.17	79	22	12
D1018BPL	£96.93	10.18mm HSS 3-Flute Intermediate Slot Drill	10.18	79	22	12
D1019BPL	£96.93	10.19mm HSS 3-Flute Intermediate Slot Drill	10.19	79	22	12
D1020BPL	£96.93	10.2mm HSS 3-Flute Intermediate Slot Drill	10.20	79	22	12
D1021BPL	£96.93	10.21mm HSS 3-Flute Intermediate Slot Drill	10.21	79	22	12
D1022BPL	£96.93	10.22mm HSS 3-Flute Intermediate Slot Drill	10.22	79	22	12
D1023BPL	£96.93	10.23mm HSS 3-Flute Intermediate Slot Drill	10.23	79	22	12
D1024BPL	£96.93	10.24mm HSS 3-Flute Intermediate Slot Drill	10.24	79	22	12
D1025BPL	£96.93	10.25mm HSS 3-Flute Intermediate Slot Drill	10.25	79	22	12
D1026BPL	£96.93	10.26mm HSS 3-Flute Intermediate Slot Drill	10.26	79	22	12
D1027BPL	£96.93	10.27mm HSS 3-Flute Intermediate Slot Drill	10.27	79	22	12
D1028BPL	£96.93	10.28mm HSS 3-Flute Intermediate Slot Drill	10.28	79	22	12
D1029BPL	£96.93	10.29mm HSS 3-Flute Intermediate Slot Drill	10.29	79	22	12

(Prices do not include VAT)

SLOT DRILLS & END MILLS
3 Flute Intermediate Slot Drills
 Supplied by Leclerc

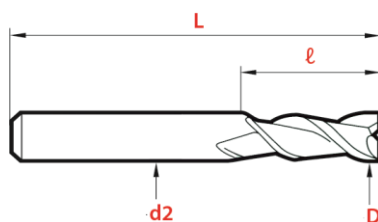

HSS M42 8% Cob

Tolerance			
D	L	ℓ	d2
-0.01	±1	+1	h6

Product Code	Price	Description	D	L	ℓ	d2
D1030BPL	£96.93	10.3mm HSS 3-Flute Intermediate Slot Drill	10.30	79	22	12
D1031BPL	£96.93	10.31mm HSS 3-Flute Intermediate Slot Drill	10.31	79	22	12
D1032BPL	£96.93	10.32mm HSS 3-Flute Intermediate Slot Drill	10.32	79	22	12
D1033BPL	£96.93	10.33mm HSS 3-Flute Intermediate Slot Drill	10.33	79	22	12
D1034BPL	£96.93	10.34mm HSS 3-Flute Intermediate Slot Drill	10.34	79	22	12
D1035BPL	£96.93	10.35mm HSS 3-Flute Intermediate Slot Drill	10.35	79	22	12
D1036BPL	£96.93	10.36mm HSS 3-Flute Intermediate Slot Drill	10.36	79	22	12
D1037BPL	£96.93	10.37mm HSS 3-Flute Intermediate Slot Drill	10.37	79	22	12
D1038BPL	£96.93	10.38mm HSS 3-Flute Intermediate Slot Drill	10.38	79	22	12
D1039BPL	£96.93	10.39mm HSS 3-Flute Intermediate Slot Drill	10.39	79	22	12
D1040BPL	£96.93	10.4mm HSS 3-Flute Intermediate Slot Drill	10.40	79	22	12
D1041BPL	£96.93	10.41mm HSS 3-Flute Intermediate Slot Drill	10.41	79	22	12
D1042BPL	£96.93	10.42mm HSS 3-Flute Intermediate Slot Drill	10.42	79	22	12
D1043BPL	£96.93	10.43mm HSS 3-Flute Intermediate Slot Drill	10.43	79	22	12
D1044BPL	£96.93	10.44mm HSS 3-Flute Intermediate Slot Drill	10.44	79	22	12
D1045BPL	£96.93	10.45mm HSS 3-Flute Intermediate Slot Drill	10.45	79	22	12
D1046BPL	£96.93	10.46mm HSS 3-Flute Intermediate Slot Drill	10.46	79	22	12
D1047BPL	£96.93	10.47mm HSS 3-Flute Intermediate Slot Drill	10.47	79	22	12
D1048BPL	£96.93	10.48mm HSS 3-Flute Intermediate Slot Drill	10.48	79	22	12
D1049BPL	£96.93	10.49mm HSS 3-Flute Intermediate Slot Drill	10.49	79	22	12
D1050BPL	£96.93	10.5mm HSS 3-Flute Intermediate Slot Drill	10.50	79	22	12
D1051BPL	£96.93	10.51mm HSS 3-Flute Intermediate Slot Drill	10.51	79	22	12
D1052BPL	£96.93	10.52mm HSS 3-Flute Intermediate Slot Drill	10.52	79	22	12
D1053BPL	£96.93	10.53mm HSS 3-Flute Intermediate Slot Drill	10.53	79	22	12
D1054BPL	£96.93	10.54mm HSS 3-Flute Intermediate Slot Drill	10.54	79	22	12
D1055BPL	£96.93	10.55mm HSS 3-Flute Intermediate Slot Drill	10.55	79	22	12
D1056BPL	£96.93	10.56mm HSS 3-Flute Intermediate Slot Drill	10.56	79	22	12
D1057BPL	£96.93	10.57mm HSS 3-Flute Intermediate Slot Drill	10.57	79	22	12
D1058BPL	£96.93	10.58mm HSS 3-Flute Intermediate Slot Drill	10.58	79	22	12
D1059BPL	£96.93	10.59mm HSS 3-Flute Intermediate Slot Drill	10.59	79	22	12
D1060BPL	£96.93	10.6mm HSS 3-Flute Intermediate Slot Drill	10.60	79	22	12
D1061BPL	£96.93	10.61mm HSS 3-Flute Intermediate Slot Drill	10.61	79	22	12
D1062BPL	£96.93	10.62mm HSS 3-Flute Intermediate Slot Drill	10.62	79	22	12
D1063BPL	£96.93	10.63mm HSS 3-Flute Intermediate Slot Drill	10.63	79	22	12
D1064BPL	£96.93	10.64mm HSS 3-Flute Intermediate Slot Drill	10.64	79	22	12
D1065BPL	£96.93	10.65mm HSS 3-Flute Intermediate Slot Drill	10.65	79	22	12
D1066BPL	£96.93	10.66mm HSS 3-Flute Intermediate Slot Drill	10.66	79	22	12
D1067BPL	£96.93	10.67mm HSS 3-Flute Intermediate Slot Drill	10.67	79	22	12
D1068BPL	£96.93	10.68mm HSS 3-Flute Intermediate Slot Drill	10.68	79	22	12
D1069BPL	£96.93	10.69mm HSS 3-Flute Intermediate Slot Drill	10.69	79	22	12
D1070BPL	£96.93	10.7mm HSS 3-Flute Intermediate Slot Drill	10.70	79	22	12
D1071BPL	£96.93	10.71mm HSS 3-Flute Intermediate Slot Drill	10.71	79	22	12
D1072BPL	£96.93	10.72mm HSS 3-Flute Intermediate Slot Drill	10.72	79	22	12
D1073BPL	£96.93	10.73mm HSS 3-Flute Intermediate Slot Drill	10.73	79	22	12

(Prices do not include VAT)

SLOT DRILLS & END MILLS
3 Flute Intermediate Slot Drills
 Supplied by Leclerc

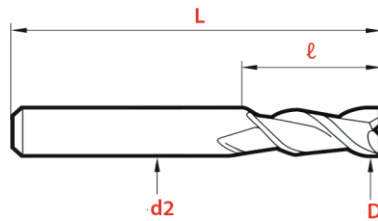

Tolerance			
D	L	ℓ	d2
-0.01	±1	+1	h6

HSS M42 8% Cob

Product Code	Price	Description	D	L	ℓ	d2
D1074BPL	£96.93	10.74mm HSS 3-Flute Intermediate Slot Drill	10.74	79	22	12
D1075BPL	£96.93	10.75mm HSS 3-Flute Intermediate Slot Drill	10.75	79	22	12
D1076BPL	£96.93	10.76mm HSS 3-Flute Intermediate Slot Drill	10.76	79	22	12
D1077BPL	£96.93	10.77mm HSS 3-Flute Intermediate Slot Drill	10.77	79	22	12
D1078BPL	£96.93	10.78mm HSS 3-Flute Intermediate Slot Drill	10.78	79	22	12
D1079BPL	£96.93	10.79mm HSS 3-Flute Intermediate Slot Drill	10.79	79	22	12
D1080BPL	£96.93	10.8mm HSS 3-Flute Intermediate Slot Drill	10.80	79	22	12
D1081BPL	£96.93	10.81mm HSS 3-Flute Intermediate Slot Drill	10.81	79	22	12
D1082BPL	£96.93	10.82mm HSS 3-Flute Intermediate Slot Drill	10.82	79	22	12
D1083BPL	£96.93	10.83mm HSS 3-Flute Intermediate Slot Drill	10.83	79	22	12
D1084BPL	£96.93	10.84mm HSS 3-Flute Intermediate Slot Drill	10.84	79	22	12
D1085BPL	£96.93	10.85mm HSS 3-Flute Intermediate Slot Drill	10.85	79	22	12
D1086BPL	£96.93	10.86mm HSS 3-Flute Intermediate Slot Drill	10.86	79	22	12
D1087BPL	£96.93	10.87mm HSS 3-Flute Intermediate Slot Drill	10.87	79	22	12
D1088BPL	£96.93	10.88mm HSS 3-Flute Intermediate Slot Drill	10.88	79	22	12
D1089BPL	£96.93	10.89mm HSS 3-Flute Intermediate Slot Drill	10.89	79	22	12
D1090BPL	£96.93	10.9mm HSS 3-Flute Intermediate Slot Drill	10.90	79	22	12
D1091BPL	£96.93	10.91mm HSS 3-Flute Intermediate Slot Drill	10.91	79	22	12
D1092BPL	£96.93	10.92mm HSS 3-Flute Intermediate Slot Drill	10.92	79	22	12
D1093BPL	£96.93	10.93mm HSS 3-Flute Intermediate Slot Drill	10.93	79	22	12
D1094BPL	£96.93	10.94mm HSS 3-Flute Intermediate Slot Drill	10.94	79	22	12
D1095BPL	£96.93	10.95mm HSS 3-Flute Intermediate Slot Drill	10.95	79	22	12
D1096BPL	£96.93	10.96mm HSS 3-Flute Intermediate Slot Drill	10.96	79	22	12
D1097BPL	£96.93	10.97mm HSS 3-Flute Intermediate Slot Drill	10.97	79	22	12
D1098BPL	£96.93	10.98mm HSS 3-Flute Intermediate Slot Drill	10.98	79	22	12
D1099BPL	£96.93	10.99mm HSS 3-Flute Intermediate Slot Drill	10.99	79	22	12
D1100BPL	£96.93	11mm HSS 3-Flute Intermediate Slot Drill	11.00	79	22	12
D1101BPL	£96.93	11.01mm HSS 3-Flute Intermediate Slot Drill	11.01	79	22	12
D1102BPL	£96.93	11.02mm HSS 3-Flute Intermediate Slot Drill	11.02	79	22	12
D1103BPL	£96.93	11.03mm HSS 3-Flute Intermediate Slot Drill	11.03	79	22	12
D1104BPL	£96.93	11.04mm HSS 3-Flute Intermediate Slot Drill	11.04	79	22	12
D1105BPL	£96.93	11.05mm HSS 3-Flute Intermediate Slot Drill	11.05	79	22	12
D1106BPL	£96.93	11.06mm HSS 3-Flute Intermediate Slot Drill	11.06	79	22	12
D1107BPL	£96.93	11.07mm HSS 3-Flute Intermediate Slot Drill	11.07	79	22	12
D1108BPL	£96.93	11.08mm HSS 3-Flute Intermediate Slot Drill	11.08	79	22	12
D1109BPL	£96.93	11.09mm HSS 3-Flute Intermediate Slot Drill	11.09	79	22	12
D1110BPL	£96.93	11.1mm HSS 3-Flute Intermediate Slot Drill	11.10	79	22	12
D1111BPL	£96.93	11.11mm HSS 3-Flute Intermediate Slot Drill	11.11	79	22	12
D1112BPL	£96.93	11.12mm HSS 3-Flute Intermediate Slot Drill	11.12	79	22	12
D1113BPL	£96.93	11.13mm HSS 3-Flute Intermediate Slot Drill	11.13	79	22	12
D1114BPL	£96.93	11.14mm HSS 3-Flute Intermediate Slot Drill	11.14	79	22	12
D1115BPL	£96.93	11.15mm HSS 3-Flute Intermediate Slot Drill	11.15	79	22	12
D1116BPL	£96.93	11.16mm HSS 3-Flute Intermediate Slot Drill	11.16	79	22	12
D1117BPL	£96.93	11.17mm HSS 3-Flute Intermediate Slot Drill	11.17	79	22	12

(Prices do not include VAT)

SLOT DRILLS & END MILLS
3 Flute Intermediate Slot Drills
 Supplied by Leclerc

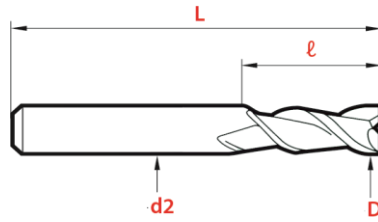

HSS M42 8% Cob

Tolerance			
D	L	ℓ	d2
-0.01	±1	+1	h6

Product Code	Price	Description	D	L	ℓ	d2
D1118BPL	£96.93	11.18mm HSS 3-Flute Intermediate Slot Drill	11.18	79	22	12
D1119BPL	£96.93	11.19mm HSS 3-Flute Intermediate Slot Drill	11.19	79	22	12
D1120BPL	£96.93	11.2mm HSS 3-Flute Intermediate Slot Drill	11.20	79	22	12
D1121BPL	£96.93	11.21mm HSS 3-Flute Intermediate Slot Drill	11.21	79	22	12
D1122BPL	£96.93	11.22mm HSS 3-Flute Intermediate Slot Drill	11.22	79	22	12
D1123BPL	£96.93	11.23mm HSS 3-Flute Intermediate Slot Drill	11.23	79	22	12
D1124BPL	£96.93	11.24mm HSS 3-Flute Intermediate Slot Drill	11.24	79	22	12
D1125BPL	£96.93	11.25mm HSS 3-Flute Intermediate Slot Drill	11.25	79	22	12
D1126BPL	£96.93	11.26mm HSS 3-Flute Intermediate Slot Drill	11.26	79	22	12
D1127BPL	£96.93	11.27mm HSS 3-Flute Intermediate Slot Drill	11.27	79	22	12
D1128BPL	£96.93	11.28mm HSS 3-Flute Intermediate Slot Drill	11.28	79	22	12
D1129BPL	£96.93	11.29mm HSS 3-Flute Intermediate Slot Drill	11.29	79	22	12
D1130BPL	£96.93	11.3mm HSS 3-Flute Intermediate Slot Drill	11.30	79	22	12
D1131BPL	£96.93	11.31mm HSS 3-Flute Intermediate Slot Drill	11.31	79	22	12
D1132BPL	£96.93	11.32mm HSS 3-Flute Intermediate Slot Drill	11.32	79	22	12
D1133BPL	£96.93	11.33mm HSS 3-Flute Intermediate Slot Drill	11.33	79	22	12
D1134BPL	£96.93	11.34mm HSS 3-Flute Intermediate Slot Drill	11.34	79	22	12
D1135BPL	£96.93	11.35mm HSS 3-Flute Intermediate Slot Drill	11.35	79	22	12
D1136BPL	£96.93	11.36mm HSS 3-Flute Intermediate Slot Drill	11.36	79	22	12
D1137BPL	£96.93	11.37mm HSS 3-Flute Intermediate Slot Drill	11.37	79	22	12
D1138BPL	£96.93	11.38mm HSS 3-Flute Intermediate Slot Drill	11.38	79	22	12
D1139BPL	£96.93	11.39mm HSS 3-Flute Intermediate Slot Drill	11.39	79	22	12
D1140BPL	£96.93	11.4mm HSS 3-Flute Intermediate Slot Drill	11.40	79	22	12
D1141BPL	£96.93	11.41mm HSS 3-Flute Intermediate Slot Drill	11.41	79	22	12
D1142BPL	£96.93	11.42mm HSS 3-Flute Intermediate Slot Drill	11.42	79	22	12
D1143BPL	£96.93	11.43mm HSS 3-Flute Intermediate Slot Drill	11.43	79	22	12
D1144BPL	£96.93	11.44mm HSS 3-Flute Intermediate Slot Drill	11.44	79	22	12
D1145BPL	£96.93	11.45mm HSS 3-Flute Intermediate Slot Drill	11.45	79	22	12
D1146BPL	£96.93	11.46mm HSS 3-Flute Intermediate Slot Drill	11.46	79	22	12
D1147BPL	£96.93	11.47mm HSS 3-Flute Intermediate Slot Drill	11.47	79	22	12
D1148BPL	£96.93	11.48mm HSS 3-Flute Intermediate Slot Drill	11.48	79	22	12
D1149BPL	£96.93	11.49mm HSS 3-Flute Intermediate Slot Drill	11.49	79	22	12
D1150BPL	£96.93	11.5mm HSS 3-Flute Intermediate Slot Drill	11.50	79	22	12
D1151BPL	£96.93	11.51mm HSS 3-Flute Intermediate Slot Drill	11.51	79	22	12
D1152BPL	£96.93	11.52mm HSS 3-Flute Intermediate Slot Drill	11.52	79	22	12
D1153BPL	£96.93	11.53mm HSS 3-Flute Intermediate Slot Drill	11.53	79	22	12
D1154BPL	£96.93	11.54mm HSS 3-Flute Intermediate Slot Drill	11.54	79	22	12
D1155BPL	£96.93	11.55mm HSS 3-Flute Intermediate Slot Drill	11.55	79	22	12
D1156BPL	£96.93	11.56mm HSS 3-Flute Intermediate Slot Drill	11.56	79	22	12
D1157BPL	£96.93	11.57mm HSS 3-Flute Intermediate Slot Drill	11.57	79	22	12
D1158BPL	£96.93	11.58mm HSS 3-Flute Intermediate Slot Drill	11.58	79	22	12
D1159BPL	£96.93	11.59mm HSS 3-Flute Intermediate Slot Drill	11.59	79	22	12
D1160BPL	£96.93	11.6mm HSS 3-Flute Intermediate Slot Drill	11.60	79	22	12
D1161BPL	£96.93	11.61mm HSS 3-Flute Intermediate Slot Drill	11.61	79	22	12

(Prices do not include VAT)

SLOT DRILLS & END MILLS

3 Flute Intermediate Slot Drills

Supplied by Leclerc

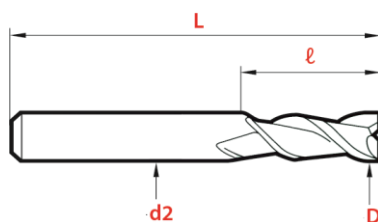

HSS M42 8% Cob

Tolerance			
D	L	ℓ	d2
-0.01	±1	+1	h6

Product Code	Price	Description	D	L	ℓ	d2
D1162BPL	£96.93	11.62mm HSS 3-Flute Intermediate Slot Drill	11.62	79	22	12
D1163BPL	£96.93	11.63mm HSS 3-Flute Intermediate Slot Drill	11.63	79	22	12
D1164BPL	£96.93	11.64mm HSS 3-Flute Intermediate Slot Drill	11.64	79	22	12
D1165BPL	£96.93	11.65mm HSS 3-Flute Intermediate Slot Drill	11.65	79	22	12
D1166BPL	£96.93	11.66mm HSS 3-Flute Intermediate Slot Drill	11.66	79	22	12
D1167BPL	£96.93	11.67mm HSS 3-Flute Intermediate Slot Drill	11.67	79	22	12
D1168BPL	£96.93	11.68mm HSS 3-Flute Intermediate Slot Drill	11.68	79	22	12
D1169BPL	£96.93	11.69mm HSS 3-Flute Intermediate Slot Drill	11.69	79	22	12
D1170BPL	£96.93	11.7mm HSS 3-Flute Intermediate Slot Drill	11.70	79	22	12
D1171BPL	£96.93	11.71mm HSS 3-Flute Intermediate Slot Drill	11.71	79	22	12
D1172BPL	£96.93	11.72mm HSS 3-Flute Intermediate Slot Drill	11.72	79	22	12
D1173BPL	£96.93	11.73mm HSS 3-Flute Intermediate Slot Drill	11.73	79	22	12
D1174BPL	£96.93	11.74mm HSS 3-Flute Intermediate Slot Drill	11.74	79	22	12
D1175BPL	£96.93	11.75mm HSS 3-Flute Intermediate Slot Drill	11.75	79	22	12
D1176BPL	£96.93	11.76mm HSS 3-Flute Intermediate Slot Drill	11.76	79	22	12
D1177BPL	£96.93	11.77mm HSS 3-Flute Intermediate Slot Drill	11.77	79	22	12
D1178BPL	£96.93	11.78mm HSS 3-Flute Intermediate Slot Drill	11.78	79	22	12
D1179BPL	£96.93	11.79mm HSS 3-Flute Intermediate Slot Drill	11.79	79	22	12
D1180BPL	£96.93	11.8mm HSS 3-Flute Intermediate Slot Drill	11.80	79	22	12
D1181BPL	£91.88	11.81mm HSS 3-Flute Intermediate Slot Drill	11.81	83	26	12
D1182BPL	£91.88	11.82mm HSS 3-Flute Intermediate Slot Drill	11.82	83	26	12
D1183BPL	£91.88	11.83mm HSS 3-Flute Intermediate Slot Drill	11.83	83	26	12
D1184BPL	£91.88	11.84mm HSS 3-Flute Intermediate Slot Drill	11.84	83	26	12
D1185BPL	£91.88	11.85mm HSS 3-Flute Intermediate Slot Drill	11.85	83	26	12
D1186BPL	£91.88	11.86mm HSS 3-Flute Intermediate Slot Drill	11.86	83	26	12
D1187BPL	£91.88	11.87mm HSS 3-Flute Intermediate Slot Drill	11.87	83	26	12
D1188BPL	£91.88	11.88mm HSS 3-Flute Intermediate Slot Drill	11.88	83	26	12
D1189BPL	£91.88	11.89mm HSS 3-Flute Intermediate Slot Drill	11.89	83	26	12
D1190BPL	£91.88	11.9mm HSS 3-Flute Intermediate Slot Drill	11.90	83	26	12
D1191BPL	£91.88	11.91mm HSS 3-Flute Intermediate Slot Drill	11.91	83	26	12
D1192BPL	£91.88	11.92mm HSS 3-Flute Intermediate Slot Drill	11.92	83	26	12
D1193BPL	£91.88	11.93mm HSS 3-Flute Intermediate Slot Drill	11.93	83	26	12
D1194BPL	£91.88	11.94mm HSS 3-Flute Intermediate Slot Drill	11.94	83	26	12
D1195BPL	£91.88	11.95mm HSS 3-Flute Intermediate Slot Drill	11.95	83	26	12
D1196BPL	£91.88	11.96mm HSS 3-Flute Intermediate Slot Drill	11.96	83	26	12
D1197BPL	£91.88	11.97mm HSS 3-Flute Intermediate Slot Drill	11.97	83	26	12
D1198BPL	£91.88	11.98mm HSS 3-Flute Intermediate Slot Drill	11.98	83	26	12
D1199BPL	£91.88	11.99mm HSS 3-Flute Intermediate Slot Drill	11.99	83	26	12
D1200BPL	£91.88	12mm HSS 3-Flute Intermediate Slot Drill	12.00	83	26	12
D1201BPL	£93.80	12.01mm HSS 3-Flute Intermediate Slot Drill	12.01	83	26	12
D1202BPL	£93.80	12.02mm HSS 3-Flute Intermediate Slot Drill	12.02	83	26	12
D1203BPL	£93.80	12.03mm HSS 3-Flute Intermediate Slot Drill	12.03	83	26	12
D1204BPL	£93.80	12.04mm HSS 3-Flute Intermediate Slot Drill	12.04	83	26	12
D1205BPL	£93.80	12.05mm HSS 3-Flute Intermediate Slot Drill	12.05	83	26	12

(Prices do not include VAT)

SLOT DRILLS & END MILLS

3 Flute Intermediate Slot Drills

Supplied by Leclerc

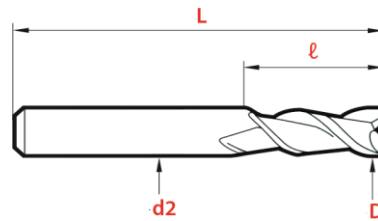

Tolerance			
D	L	ℓ	d2
-0.01	±1	+1	h6

HSS M42 8% Cob

Product Code	Price	Description	D	L	ℓ	d2
D1206BPL	£93.80	12.06mm HSS 3-Flute Intermediate Slot Drill	12.06	83	26	12
D1207BPL	£93.80	12.07mm HSS 3-Flute Intermediate Slot Drill	12.07	83	26	12
D1208BPL	£93.80	12.08mm HSS 3-Flute Intermediate Slot Drill	12.08	83	26	12
D1209BPL	£93.80	12.09mm HSS 3-Flute Intermediate Slot Drill	12.09	83	26	12
D1210BPL	£93.80	12.1mm HSS 3-Flute Intermediate Slot Drill	12.10	83	26	12
D1211BPL	£93.80	12.11mm HSS 3-Flute Intermediate Slot Drill	12.11	83	26	12
D1212BPL	£93.80	12.12mm HSS 3-Flute Intermediate Slot Drill	12.12	83	26	12
D1213BPL	£93.80	12.13mm HSS 3-Flute Intermediate Slot Drill	12.13	83	26	12
D1214BPL	£93.80	12.14mm HSS 3-Flute Intermediate Slot Drill	12.14	83	26	12
D1215BPL	£93.80	12.15mm HSS 3-Flute Intermediate Slot Drill	12.15	83	26	12
D1216BPL	£93.80	12.16mm HSS 3-Flute Intermediate Slot Drill	12.16	83	26	12
D1217BPL	£93.80	12.17mm HSS 3-Flute Intermediate Slot Drill	12.17	83	26	12
D1218BPL	£93.80	12.18mm HSS 3-Flute Intermediate Slot Drill	12.18	83	26	12
D1219BPL	£93.80	12.19mm HSS 3-Flute Intermediate Slot Drill	12.19	83	26	12
D1220BPL	£93.80	12.2mm HSS 3-Flute Intermediate Slot Drill	12.20	83	26	12
D1221BPL	£93.80	12.21mm HSS 3-Flute Intermediate Slot Drill	12.21	83	26	12
D1222BPL	£93.80	12.22mm HSS 3-Flute Intermediate Slot Drill	12.22	83	26	12
D1223BPL	£93.80	12.23mm HSS 3-Flute Intermediate Slot Drill	12.23	83	26	12
D1224BPL	£93.80	12.24mm HSS 3-Flute Intermediate Slot Drill	12.24	83	26	12
D1225BPL	£93.80	12.25mm HSS 3-Flute Intermediate Slot Drill	12.25	83	26	12
D1226BPL	£93.80	12.26mm HSS 3-Flute Intermediate Slot Drill	12.26	83	26	12
D1227BPL	£93.80	12.27mm HSS 3-Flute Intermediate Slot Drill	12.27	83	26	12
D1228BPL	£93.80	12.28mm HSS 3-Flute Intermediate Slot Drill	12.28	83	26	12
D1229BPL	£93.80	12.29mm HSS 3-Flute Intermediate Slot Drill	12.29	83	26	12
D1230BPL	£93.80	12.3mm HSS 3-Flute Intermediate Slot Drill	12.30	83	26	12
D1231BPL	£93.80	12.31mm HSS 3-Flute Intermediate Slot Drill	12.31	83	26	12
D1232BPL	£93.80	12.32mm HSS 3-Flute Intermediate Slot Drill	12.32	83	26	12
D1233BPL	£93.80	12.33mm HSS 3-Flute Intermediate Slot Drill	12.33	83	26	12
D1234BPL	£93.80	12.34mm HSS 3-Flute Intermediate Slot Drill	12.34	83	26	12
D1235BPL	£93.80	12.35mm HSS 3-Flute Intermediate Slot Drill	12.35	83	26	12
D1236BPL	£93.80	12.36mm HSS 3-Flute Intermediate Slot Drill	12.36	83	26	12
D1237BPL	£93.80	12.37mm HSS 3-Flute Intermediate Slot Drill	12.37	83	26	12
D1238BPL	£93.80	12.38mm HSS 3-Flute Intermediate Slot Drill	12.38	83	26	12
D1239BPL	£93.80	12.39mm HSS 3-Flute Intermediate Slot Drill	12.39	83	26	12
D1240BPL	£93.80	12.4mm HSS 3-Flute Intermediate Slot Drill	12.40	83	26	12
D1241BPL	£93.80	12.41mm HSS 3-Flute Intermediate Slot Drill	12.41	83	26	12
D1242BPL	£93.80	12.42mm HSS 3-Flute Intermediate Slot Drill	12.42	83	26	12
D1243BPL	£93.80	12.43mm HSS 3-Flute Intermediate Slot Drill	12.43	83	26	12
D1244BPL	£93.80	12.44mm HSS 3-Flute Intermediate Slot Drill	12.44	83	26	12
D1245BPL	£93.80	12.45mm HSS 3-Flute Intermediate Slot Drill	12.45	83	26	12
D1246BPL	£93.80	12.46mm HSS 3-Flute Intermediate Slot Drill	12.46	83	26	12
D1247BPL	£93.80	12.47mm HSS 3-Flute Intermediate Slot Drill	12.47	83	26	12
D1248BPL	£93.80	12.48mm HSS 3-Flute Intermediate Slot Drill	12.48	83	26	12
D1249BPL	£93.80	12.49mm HSS 3-Flute Intermediate Slot Drill	12.49	83	26	12

(Prices do not include VAT)

SLOT DRILLS & END MILLS

3 Flute Intermediate Slot Drills

Supplied by Leclerc

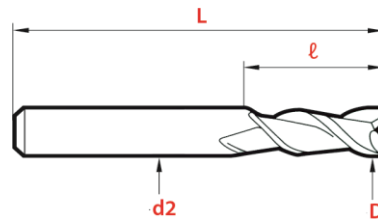

HSS M42 8% Cob

Tolerance			
D	L	ℓ	d2
-0.01	±1	+1	h6

Product Code	Price	Description	D	L	ℓ	d2
D1250BPL	£93.80	12.5mm HSS 3-Flute Intermediate Slot Drill	12.50	83	26	12
D1251BPL	£93.80	12.51mm HSS 3-Flute Intermediate Slot Drill	12.51	83	26	12
D1252BPL	£93.80	12.52mm HSS 3-Flute Intermediate Slot Drill	12.52	83	26	12
D1253BPL	£93.80	12.53mm HSS 3-Flute Intermediate Slot Drill	12.53	83	26	12
D1254BPL	£93.80	12.54mm HSS 3-Flute Intermediate Slot Drill	12.54	83	26	12
D1255BPL	£93.80	12.55mm HSS 3-Flute Intermediate Slot Drill	12.55	83	26	12
D1256BPL	£93.80	12.56mm HSS 3-Flute Intermediate Slot Drill	12.56	83	26	12
D1257BPL	£93.80	12.57mm HSS 3-Flute Intermediate Slot Drill	12.57	83	26	12
D1258BPL	£93.80	12.58mm HSS 3-Flute Intermediate Slot Drill	12.58	83	26	12
D1259BPL	£93.80	12.59mm HSS 3-Flute Intermediate Slot Drill	12.59	83	26	12
D1260BPL	£93.80	12.6mm HSS 3-Flute Intermediate Slot Drill	12.60	83	26	12
D1261BPL	£93.80	12.61mm HSS 3-Flute Intermediate Slot Drill	12.61	83	26	12
D1262BPL	£93.80	12.62mm HSS 3-Flute Intermediate Slot Drill	12.62	83	26	12
D1263BPL	£93.80	12.63mm HSS 3-Flute Intermediate Slot Drill	12.63	83	26	12
D1264BPL	£93.80	12.64mm HSS 3-Flute Intermediate Slot Drill	12.64	83	26	12
D1265BPL	£93.80	12.65mm HSS 3-Flute Intermediate Slot Drill	12.65	83	26	12
D1266BPL	£93.80	12.66mm HSS 3-Flute Intermediate Slot Drill	12.66	83	26	12
D1267BPL	£93.80	12.67mm HSS 3-Flute Intermediate Slot Drill	12.67	83	26	12
D1268BPL	£93.80	12.68mm HSS 3-Flute Intermediate Slot Drill	12.68	83	26	12
D1269BPL	£93.80	12.69mm HSS 3-Flute Intermediate Slot Drill	12.69	83	26	12
D1270BPL	£93.80	12.7mm HSS 3-Flute Intermediate Slot Drill	12.70	83	26	12
D1271BPL	£93.80	12.71mm HSS 3-Flute Intermediate Slot Drill	12.71	83	26	12
D1272BPL	£93.80	12.72mm HSS 3-Flute Intermediate Slot Drill	12.72	83	26	12
D1273BPL	£93.80	12.73mm HSS 3-Flute Intermediate Slot Drill	12.73	83	26	12
D1274BPL	£93.80	12.74mm HSS 3-Flute Intermediate Slot Drill	12.74	83	26	12
D1275BPL	£93.80	12.75mm HSS 3-Flute Intermediate Slot Drill	12.75	83	26	12
D1276BPL	£93.80	12.76mm HSS 3-Flute Intermediate Slot Drill	12.76	83	26	12
D1277BPL	£93.80	12.77mm HSS 3-Flute Intermediate Slot Drill	12.77	83	26	12
D1278BPL	£93.80	12.78mm HSS 3-Flute Intermediate Slot Drill	12.78	83	26	12
D1279BPL	£93.80	12.79mm HSS 3-Flute Intermediate Slot Drill	12.79	83	26	12
D1280BPL	£93.80	12.8mm HSS 3-Flute Intermediate Slot Drill	12.80	83	26	12
D1281BPL	£93.80	12.81mm HSS 3-Flute Intermediate Slot Drill	12.81	83	26	12
D1282BPL	£93.80	12.82mm HSS 3-Flute Intermediate Slot Drill	12.82	83	26	12
D1283BPL	£93.80	12.83mm HSS 3-Flute Intermediate Slot Drill	12.83	83	26	12
D1284BPL	£93.80	12.84mm HSS 3-Flute Intermediate Slot Drill	12.84	83	26	12
D1285BPL	£93.80	12.85mm HSS 3-Flute Intermediate Slot Drill	12.85	83	26	12
D1286BPL	£93.80	12.86mm HSS 3-Flute Intermediate Slot Drill	12.86	83	26	12
D1287BPL	£93.80	12.87mm HSS 3-Flute Intermediate Slot Drill	12.87	83	26	12
D1288BPL	£93.80	12.88mm HSS 3-Flute Intermediate Slot Drill	12.88	83	26	12
D1289BPL	£93.80	12.89mm HSS 3-Flute Intermediate Slot Drill	12.89	83	26	12
D1290BPL	£93.80	12.9mm HSS 3-Flute Intermediate Slot Drill	12.90	83	26	12
D1291BPL	£93.80	12.91mm HSS 3-Flute Intermediate Slot Drill	12.91	83	26	12
D1292BPL	£93.80	12.92mm HSS 3-Flute Intermediate Slot Drill	12.92	83	26	12
D1293BPL	£93.80	12.93mm HSS 3-Flute Intermediate Slot Drill	12.93	83	26	12

(Prices do not include VAT)

SLOT DRILLS & END MILLS
3 Flute Intermediate Slot Drills
 Supplied by Leclerc

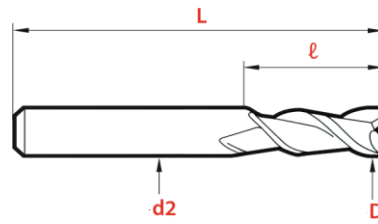

HSS M42 8% Cob

Tolerance			
D	L	ℓ	d2
-0.01	±1	+1	h6

Product Code	Price	Description	D	L	ℓ	d2
D1294BPL	£93.80	12.94mm HSS 3-Flute Intermediate Slot Drill	12.94	83	26	12
D1295BPL	£93.80	12.95mm HSS 3-Flute Intermediate Slot Drill	12.95	83	26	12
D1296BPL	£93.80	12.96mm HSS 3-Flute Intermediate Slot Drill	12.96	83	26	12
D1297BPL	£93.80	12.97mm HSS 3-Flute Intermediate Slot Drill	12.97	83	26	12
D1298BPL	£93.80	12.98mm HSS 3-Flute Intermediate Slot Drill	12.98	83	26	12
D1299BPL	£93.80	12.99mm HSS 3-Flute Intermediate Slot Drill	12.99	83	26	12
D1300BPL	£93.80	13mm HSS 3-Flute Intermediate Slot Drill	13.00	83	26	12
D1301BPL	£93.80	13.01mm HSS 3-Flute Intermediate Slot Drill	13.01	83	26	12
D1302BPL	£93.80	13.02mm HSS 3-Flute Intermediate Slot Drill	13.02	83	26	12
D1303BPL	£93.80	13.03mm HSS 3-Flute Intermediate Slot Drill	13.03	83	26	12
D1304BPL	£93.80	13.04mm HSS 3-Flute Intermediate Slot Drill	13.04	83	26	12
D1305BPL	£93.80	13.05mm HSS 3-Flute Intermediate Slot Drill	13.05	83	26	12
D1306BPL	£93.80	13.06mm HSS 3-Flute Intermediate Slot Drill	13.06	83	26	12
D1307BPL	£93.80	13.07mm HSS 3-Flute Intermediate Slot Drill	13.07	83	26	12
D1308BPL	£93.80	13.08mm HSS 3-Flute Intermediate Slot Drill	13.08	83	26	12
D1309BPL	£93.80	13.09mm HSS 3-Flute Intermediate Slot Drill	13.09	83	26	12
D1310BPL	£93.80	13.1mm HSS 3-Flute Intermediate Slot Drill	13.10	83	26	12
D1311BPL	£93.80	13.11mm HSS 3-Flute Intermediate Slot Drill	13.11	83	26	12
D1312BPL	£93.80	13.12mm HSS 3-Flute Intermediate Slot Drill	13.12	83	26	12
D1313BPL	£93.80	13.13mm HSS 3-Flute Intermediate Slot Drill	13.13	83	26	12
D1314BPL	£93.80	13.14mm HSS 3-Flute Intermediate Slot Drill	13.14	83	26	12
D1315BPL	£93.80	13.15mm HSS 3-Flute Intermediate Slot Drill	13.15	83	26	12
D1316BPL	£93.80	13.16mm HSS 3-Flute Intermediate Slot Drill	13.16	83	26	12
D1317BPL	£93.80	13.17mm HSS 3-Flute Intermediate Slot Drill	13.17	83	26	12
D1318BPL	£93.80	13.18mm HSS 3-Flute Intermediate Slot Drill	13.18	83	26	12
D1319BPL	£93.80	13.19mm HSS 3-Flute Intermediate Slot Drill	13.19	83	26	12
D1320BPL	£93.80	13.2mm HSS 3-Flute Intermediate Slot Drill	13.20	83	26	12
D1321BPL	£93.80	13.21mm HSS 3-Flute Intermediate Slot Drill	13.21	83	26	12
D1322BPL	£93.80	13.22mm HSS 3-Flute Intermediate Slot Drill	13.22	83	26	12
D1323BPL	£93.80	13.23mm HSS 3-Flute Intermediate Slot Drill	13.23	83	26	12
D1324BPL	£93.80	13.24mm HSS 3-Flute Intermediate Slot Drill	13.24	83	26	12
D1325BPL	£93.80	13.25mm HSS 3-Flute Intermediate Slot Drill	13.25	83	26	12
D1326BPL	£93.80	13.26mm HSS 3-Flute Intermediate Slot Drill	13.26	83	26	12
D1327BPL	£93.80	13.27mm HSS 3-Flute Intermediate Slot Drill	13.27	83	26	12
D1328BPL	£93.80	13.28mm HSS 3-Flute Intermediate Slot Drill	13.28	83	26	12
D1329BPL	£93.80	13.29mm HSS 3-Flute Intermediate Slot Drill	13.29	83	26	12
D1330BPL	£93.80	13.3mm HSS 3-Flute Intermediate Slot Drill	13.30	83	26	12
D1331BPL	£93.80	13.31mm HSS 3-Flute Intermediate Slot Drill	13.31	83	26	12
D1332BPL	£93.80	13.32mm HSS 3-Flute Intermediate Slot Drill	13.32	83	26	12
D1333BPL	£93.80	13.33mm HSS 3-Flute Intermediate Slot Drill	13.33	83	26	12
D1334BPL	£93.80	13.34mm HSS 3-Flute Intermediate Slot Drill	13.34	83	26	12
D1335BPL	£93.80	13.35mm HSS 3-Flute Intermediate Slot Drill	13.35	83	26	12
D1336BPL	£93.80	13.36mm HSS 3-Flute Intermediate Slot Drill	13.36	83	26	12
D1337BPL	£93.80	13.37mm HSS 3-Flute Intermediate Slot Drill	13.37	83	26	12

(Prices do not include VAT)

SLOT DRILLS & END MILLS
3 Flute Intermediate Slot Drills
 Supplied by Leclerc

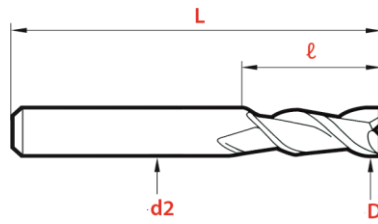

HSS M42 8% Cob

Tolerance			
D	L	ℓ	d2
-0.01	±1	+1	h6

Product Code	Price	Description	D	L	ℓ	d2
D1338BPL	£93.80	13.38mm HSS 3-Flute Intermediate Slot Drill	13.38	83	26	12
D1339BPL	£93.80	13.39mm HSS 3-Flute Intermediate Slot Drill	13.39	83	26	12
D1340BPL	£93.80	13.4mm HSS 3-Flute Intermediate Slot Drill	13.40	83	26	12
D1341BPL	£93.80	13.41mm HSS 3-Flute Intermediate Slot Drill	13.41	83	26	12
D1342BPL	£93.80	13.42mm HSS 3-Flute Intermediate Slot Drill	13.42	83	26	12
D1343BPL	£93.80	13.43mm HSS 3-Flute Intermediate Slot Drill	13.43	83	26	12
D1344BPL	£93.80	13.44mm HSS 3-Flute Intermediate Slot Drill	13.44	83	26	12
D1345BPL	£93.80	13.45mm HSS 3-Flute Intermediate Slot Drill	13.45	83	26	12
D1346BPL	£93.80	13.46mm HSS 3-Flute Intermediate Slot Drill	13.46	83	26	12
D1347BPL	£93.80	13.47mm HSS 3-Flute Intermediate Slot Drill	13.47	83	26	12
D1348BPL	£93.80	13.48mm HSS 3-Flute Intermediate Slot Drill	13.48	83	26	12
D1349BPL	£93.80	13.49mm HSS 3-Flute Intermediate Slot Drill	13.49	83	26	12
D1350BPL	£93.80	13.5mm HSS 3-Flute Intermediate Slot Drill	13.50	83	26	12
D1351BPL	£93.80	13.51mm HSS 3-Flute Intermediate Slot Drill	13.51	83	26	12
D1352BPL	£93.80	13.52mm HSS 3-Flute Intermediate Slot Drill	13.52	83	26	12
D1353BPL	£93.80	13.53mm HSS 3-Flute Intermediate Slot Drill	13.53	83	26	12
D1354BPL	£93.80	13.54mm HSS 3-Flute Intermediate Slot Drill	13.54	83	26	12
D1355BPL	£93.80	13.55mm HSS 3-Flute Intermediate Slot Drill	13.55	83	26	12
D1356BPL	£93.80	13.56mm HSS 3-Flute Intermediate Slot Drill	13.56	83	26	12
D1357BPL	£93.80	13.57mm HSS 3-Flute Intermediate Slot Drill	13.57	83	26	12
D1358BPL	£93.80	13.58mm HSS 3-Flute Intermediate Slot Drill	13.58	83	26	12
D1359BPL	£93.80	13.59mm HSS 3-Flute Intermediate Slot Drill	13.59	83	26	12
D1360BPL	£93.80	13.6mm HSS 3-Flute Intermediate Slot Drill	13.60	83	26	12
D1361BPL	£93.80	13.61mm HSS 3-Flute Intermediate Slot Drill	13.61	83	26	12
D1362BPL	£93.80	13.62mm HSS 3-Flute Intermediate Slot Drill	13.62	83	26	12
D1363BPL	£93.80	13.63mm HSS 3-Flute Intermediate Slot Drill	13.63	83	26	12
D1364BPL	£93.80	13.64mm HSS 3-Flute Intermediate Slot Drill	13.64	83	26	12
D1365BPL	£93.80	13.65mm HSS 3-Flute Intermediate Slot Drill	13.65	83	26	12
D1366BPL	£93.80	13.66mm HSS 3-Flute Intermediate Slot Drill	13.66	83	26	12
D1367BPL	£93.80	13.67mm HSS 3-Flute Intermediate Slot Drill	13.67	83	26	12
D1368BPL	£93.80	13.68mm HSS 3-Flute Intermediate Slot Drill	13.68	83	26	12
D1369BPL	£93.80	13.69mm HSS 3-Flute Intermediate Slot Drill	13.69	83	26	12
D1370BPL	£93.80	13.7mm HSS 3-Flute Intermediate Slot Drill	13.70	83	26	12
D1371BPL	£93.80	13.71mm HSS 3-Flute Intermediate Slot Drill	13.71	83	26	12
D1372BPL	£93.80	13.72mm HSS 3-Flute Intermediate Slot Drill	13.72	83	26	12
D1373BPL	£93.80	13.73mm HSS 3-Flute Intermediate Slot Drill	13.73	83	26	12
D1374BPL	£93.80	13.74mm HSS 3-Flute Intermediate Slot Drill	13.74	83	26	12
D1375BPL	£93.80	13.75mm HSS 3-Flute Intermediate Slot Drill	13.75	83	26	12
D1376BPL	£93.80	13.76mm HSS 3-Flute Intermediate Slot Drill	13.76	83	26	12
D1377BPL	£93.80	13.77mm HSS 3-Flute Intermediate Slot Drill	13.77	83	26	12
D1378BPL	£93.80	13.78mm HSS 3-Flute Intermediate Slot Drill	13.78	83	26	12
D1379BPL	£93.80	13.79mm HSS 3-Flute Intermediate Slot Drill	13.79	83	26	12
D1380BPL	£93.80	13.8mm HSS 3-Flute Intermediate Slot Drill	13.80	83	26	12
D1381BPL	£93.80	13.81mm HSS 3-Flute Intermediate Slot Drill	13.81	83	26	12

(Prices do not include VAT)

SLOT DRILLS & END MILLS
3 Flute Intermediate Slot Drills
 Supplied by Leclerc

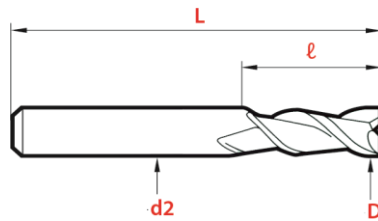

HSS M42 8% Cob

Tolerance			
D	L	ℓ	d2
-0.01	±1	+1	h6

Product Code	Price	Description	D	L	ℓ	d2
D1382BPL	£93.80	13.82mm HSS 3-Flute Intermediate Slot Drill	13.82	83	26	12
D1383BPL	£93.80	13.83mm HSS 3-Flute Intermediate Slot Drill	13.83	83	26	12
D1384BPL	£93.80	13.84mm HSS 3-Flute Intermediate Slot Drill	13.84	83	26	12
D1385BPL	£93.80	13.85mm HSS 3-Flute Intermediate Slot Drill	13.85	83	26	12
D1386BPL	£93.80	13.86mm HSS 3-Flute Intermediate Slot Drill	13.86	83	26	12
D1387BPL	£93.80	13.87mm HSS 3-Flute Intermediate Slot Drill	13.87	83	26	12
D1388BPL	£93.80	13.88mm HSS 3-Flute Intermediate Slot Drill	13.88	83	26	12
D1389BPL	£93.80	13.89mm HSS 3-Flute Intermediate Slot Drill	13.89	83	26	12
D1390BPL	£93.80	13.9mm HSS 3-Flute Intermediate Slot Drill	13.90	83	26	12
D1391BPL	£93.80	13.91mm HSS 3-Flute Intermediate Slot Drill	13.91	83	26	12
D1392BPL	£93.80	13.92mm HSS 3-Flute Intermediate Slot Drill	13.92	83	26	12
D1393BPL	£93.80	13.93mm HSS 3-Flute Intermediate Slot Drill	13.93	83	26	12
D1394BPL	£93.80	13.94mm HSS 3-Flute Intermediate Slot Drill	13.94	83	26	12
D1395BPL	£93.80	13.95mm HSS 3-Flute Intermediate Slot Drill	13.95	83	26	12
D1396BPL	£93.80	13.96mm HSS 3-Flute Intermediate Slot Drill	13.96	83	26	12
D1397BPL	£93.80	13.97mm HSS 3-Flute Intermediate Slot Drill	13.97	83	26	12
D1398BPL	£93.80	13.98mm HSS 3-Flute Intermediate Slot Drill	13.98	83	26	12
D1399BPL	£93.80	13.99mm HSS 3-Flute Intermediate Slot Drill	13.99	83	26	12
D1400BPL	£93.80	14mm HSS 3-Flute Intermediate Slot Drill	14.00	83	26	12
D1401BPL	£103.47	14.01mm HSS 3-Flute Intermediate Slot Drill	14.01	83	26	12
D1402BPL	£103.47	14.02mm HSS 3-Flute Intermediate Slot Drill	14.02	83	26	12
D1403BPL	£103.47	14.03mm HSS 3-Flute Intermediate Slot Drill	14.03	83	26	12
D1404BPL	£103.47	14.04mm HSS 3-Flute Intermediate Slot Drill	14.04	83	26	12
D1405BPL	£103.47	14.05mm HSS 3-Flute Intermediate Slot Drill	14.05	83	26	12
D1406BPL	£103.47	14.06mm HSS 3-Flute Intermediate Slot Drill	14.06	83	26	12
D1407BPL	£103.47	14.07mm HSS 3-Flute Intermediate Slot Drill	14.07	83	26	12
D1408BPL	£103.47	14.08mm HSS 3-Flute Intermediate Slot Drill	14.08	83	26	12
D1409BPL	£103.47	14.09mm HSS 3-Flute Intermediate Slot Drill	14.09	83	26	12
D1410BPL	£103.47	14.1mm HSS 3-Flute Intermediate Slot Drill	14.10	83	26	12
D1411BPL	£103.47	14.11mm HSS 3-Flute Intermediate Slot Drill	14.11	83	26	12
D1412BPL	£103.47	14.12mm HSS 3-Flute Intermediate Slot Drill	14.12	83	26	12
D1413BPL	£103.47	14.13mm HSS 3-Flute Intermediate Slot Drill	14.13	83	26	12
D1414BPL	£103.47	14.14mm HSS 3-Flute Intermediate Slot Drill	14.14	83	26	12
D1415BPL	£103.47	14.15mm HSS 3-Flute Intermediate Slot Drill	14.15	83	26	12
D1416BPL	£103.47	14.16mm HSS 3-Flute Intermediate Slot Drill	14.16	83	26	12
D1417BPL	£103.47	14.17mm HSS 3-Flute Intermediate Slot Drill	14.17	83	26	12
D1418BPL	£103.47	14.18mm HSS 3-Flute Intermediate Slot Drill	14.18	83	26	12
D1419BPL	£103.47	14.19mm HSS 3-Flute Intermediate Slot Drill	14.19	83	26	12
D1420BPL	£103.47	14.2mm HSS 3-Flute Intermediate Slot Drill	14.20	83	26	12
D1421BPL	£103.47	14.21mm HSS 3-Flute Intermediate Slot Drill	14.21	83	26	12
D1422BPL	£103.47	14.22mm HSS 3-Flute Intermediate Slot Drill	14.22	83	26	12
D1423BPL	£103.47	14.23mm HSS 3-Flute Intermediate Slot Drill	14.23	83	26	12
D1424BPL	£103.47	14.24mm HSS 3-Flute Intermediate Slot Drill	14.24	83	26	12
D1425BPL	£103.47	14.25mm HSS 3-Flute Intermediate Slot Drill	14.25	83	26	12

(Prices do not include VAT)

SLOT DRILLS & END MILLS

3 Flute Intermediate Slot Drills

Supplied by Leclerc

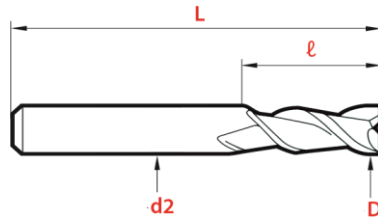

Tolerance			
D	L	ℓ	d2
-0.01	±1	+1	h6

HSS M42 8% Cob

Product Code	Price	Description	D	L	ℓ	d2
D1426BPL	£103.47	14.26mm HSS 3-Flute Intermediate Slot Drill	14.26	83	26	12
D1427BPL	£103.47	14.27mm HSS 3-Flute Intermediate Slot Drill	14.27	83	26	12
D1428BPL	£103.47	14.28mm HSS 3-Flute Intermediate Slot Drill	14.28	83	26	12
D1429BPL	£103.47	14.29mm HSS 3-Flute Intermediate Slot Drill	14.29	83	26	12
D1430BPL	£103.47	14.3mm HSS 3-Flute Intermediate Slot Drill	14.30	83	26	12
D1431BPL	£103.47	14.31mm HSS 3-Flute Intermediate Slot Drill	14.31	83	26	12
D1432BPL	£103.47	14.32mm HSS 3-Flute Intermediate Slot Drill	14.32	83	26	12
D1433BPL	£103.47	14.33mm HSS 3-Flute Intermediate Slot Drill	14.33	83	26	12
D1434BPL	£103.47	14.34mm HSS 3-Flute Intermediate Slot Drill	14.34	83	26	12
D1435BPL	£103.47	14.35mm HSS 3-Flute Intermediate Slot Drill	14.35	83	26	12
D1436BPL	£103.47	14.36mm HSS 3-Flute Intermediate Slot Drill	14.36	83	26	12
D1437BPL	£103.47	14.37mm HSS 3-Flute Intermediate Slot Drill	14.37	83	26	12
D1438BPL	£103.47	14.38mm HSS 3-Flute Intermediate Slot Drill	14.38	83	26	12
D1439BPL	£103.47	14.39mm HSS 3-Flute Intermediate Slot Drill	14.39	83	26	12
D1440BPL	£103.47	14.4mm HSS 3-Flute Intermediate Slot Drill	14.40	83	26	12
D1441BPL	£103.47	14.41mm HSS 3-Flute Intermediate Slot Drill	14.41	83	26	12
D1442BPL	£103.47	14.42mm HSS 3-Flute Intermediate Slot Drill	14.42	83	26	12
D1443BPL	£103.47	14.43mm HSS 3-Flute Intermediate Slot Drill	14.43	83	26	12
D1444BPL	£103.47	14.44mm HSS 3-Flute Intermediate Slot Drill	14.44	83	26	12
D1445BPL	£103.47	14.45mm HSS 3-Flute Intermediate Slot Drill	14.45	83	26	12
D1446BPL	£103.47	14.46mm HSS 3-Flute Intermediate Slot Drill	14.46	83	26	12
D1447BPL	£103.47	14.47mm HSS 3-Flute Intermediate Slot Drill	14.47	83	26	12
D1448BPL	£103.47	14.48mm HSS 3-Flute Intermediate Slot Drill	14.48	83	26	12
D1449BPL	£103.47	14.49mm HSS 3-Flute Intermediate Slot Drill	14.49	83	26	12
D1450BPL	£103.47	14.5mm HSS 3-Flute Intermediate Slot Drill	14.50	83	26	12
D1451BPL	£103.47	14.51mm HSS 3-Flute Intermediate Slot Drill	14.51	83	26	12
D1452BPL	£103.47	14.52mm HSS 3-Flute Intermediate Slot Drill	14.52	83	26	12
D1453BPL	£103.47	14.53mm HSS 3-Flute Intermediate Slot Drill	14.53	83	26	12
D1454BPL	£103.47	14.54mm HSS 3-Flute Intermediate Slot Drill	14.54	83	26	12
D1455BPL	£103.47	14.55mm HSS 3-Flute Intermediate Slot Drill	14.55	83	26	12
D1456BPL	£103.47	14.56mm HSS 3-Flute Intermediate Slot Drill	14.56	83	26	12
D1457BPL	£103.47	14.57mm HSS 3-Flute Intermediate Slot Drill	14.57	83	26	12
D1458BPL	£103.47	14.58mm HSS 3-Flute Intermediate Slot Drill	14.58	83	26	12
D1459BPL	£103.47	14.59mm HSS 3-Flute Intermediate Slot Drill	14.59	83	26	12
D1460BPL	£103.47	14.6mm HSS 3-Flute Intermediate Slot Drill	14.60	83	26	12
D1461BPL	£103.47	14.61mm HSS 3-Flute Intermediate Slot Drill	14.61	83	26	12
D1462BPL	£103.47	14.62mm HSS 3-Flute Intermediate Slot Drill	14.62	83	26	12
D1463BPL	£103.47	14.63mm HSS 3-Flute Intermediate Slot Drill	14.63	83	26	12
D1464BPL	£103.47	14.64mm HSS 3-Flute Intermediate Slot Drill	14.64	83	26	12
D1465BPL	£103.47	14.65mm HSS 3-Flute Intermediate Slot Drill	14.65	83	26	12
D1466BPL	£103.47	14.66mm HSS 3-Flute Intermediate Slot Drill	14.66	83	26	12
D1467BPL	£103.47	14.67mm HSS 3-Flute Intermediate Slot Drill	14.67	83	26	12
D1468BPL	£103.47	14.68mm HSS 3-Flute Intermediate Slot Drill	14.68	83	26	12
D1469BPL	£103.47	14.69mm HSS 3-Flute Intermediate Slot Drill	14.69	83	26	12

(Prices do not include VAT)

SLOT DRILLS & END MILLS

3 Flute Intermediate Slot Drills

Supplied by Leclerc

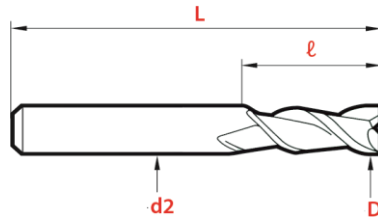

HSS M42 8% Cob

Tolerance			
D	L	ℓ	d2
-0.01	±1	+1	h6

Product Code	Price	Description	D	L	ℓ	d2
D1470BPL	£103.47	14.7mm HSS 3-Flute Intermediate Slot Drill	14.70	83	26	12
D1471BPL	£103.47	14.71mm HSS 3-Flute Intermediate Slot Drill	14.71	83	26	12
D1472BPL	£103.47	14.72mm HSS 3-Flute Intermediate Slot Drill	14.72	83	26	12
D1473BPL	£103.47	14.73mm HSS 3-Flute Intermediate Slot Drill	14.73	83	26	12
D1474BPL	£103.47	14.74mm HSS 3-Flute Intermediate Slot Drill	14.74	83	26	12
D1475BPL	£103.47	14.75mm HSS 3-Flute Intermediate Slot Drill	14.75	83	26	12
D1476BPL	£103.47	14.76mm HSS 3-Flute Intermediate Slot Drill	14.76	83	26	12
D1477BPL	£103.47	14.77mm HSS 3-Flute Intermediate Slot Drill	14.77	83	26	12
D1478BPL	£103.47	14.78mm HSS 3-Flute Intermediate Slot Drill	14.78	83	26	12
D1479BPL	£103.47	14.79mm HSS 3-Flute Intermediate Slot Drill	14.79	83	26	12
D1480BPL	£103.47	14.8mm HSS 3-Flute Intermediate Slot Drill	14.80	83	26	12
D1481BPL	£103.47	14.81mm HSS 3-Flute Intermediate Slot Drill	14.81	83	26	12
D1482BPL	£103.47	14.82mm HSS 3-Flute Intermediate Slot Drill	14.82	83	26	12
D1483BPL	£103.47	14.83mm HSS 3-Flute Intermediate Slot Drill	14.83	83	26	12
D1484BPL	£103.47	14.84mm HSS 3-Flute Intermediate Slot Drill	14.84	83	26	12
D1485BPL	£103.47	14.85mm HSS 3-Flute Intermediate Slot Drill	14.85	83	26	12
D1486BPL	£103.47	14.86mm HSS 3-Flute Intermediate Slot Drill	14.86	83	26	12
D1487BPL	£103.47	14.87mm HSS 3-Flute Intermediate Slot Drill	14.87	83	26	12
D1488BPL	£103.47	14.88mm HSS 3-Flute Intermediate Slot Drill	14.88	83	26	12
D1489BPL	£103.47	14.89mm HSS 3-Flute Intermediate Slot Drill	14.89	83	26	12
D1490BPL	£103.47	14.9mm HSS 3-Flute Intermediate Slot Drill	14.90	83	26	12
D1491BPL	£103.47	14.91mm HSS 3-Flute Intermediate Slot Drill	14.91	83	26	12
D1492BPL	£103.47	14.92mm HSS 3-Flute Intermediate Slot Drill	14.92	83	26	12
D1493BPL	£103.47	14.93mm HSS 3-Flute Intermediate Slot Drill	14.93	83	26	12
D1494BPL	£103.47	14.94mm HSS 3-Flute Intermediate Slot Drill	14.94	83	26	12
D1495BPL	£103.47	14.95mm HSS 3-Flute Intermediate Slot Drill	14.95	83	26	12
D1496BPL	£103.47	14.96mm HSS 3-Flute Intermediate Slot Drill	14.96	83	26	12
D1497BPL	£103.47	14.97mm HSS 3-Flute Intermediate Slot Drill	14.97	83	26	12
D1498BPL	£103.47	14.98mm HSS 3-Flute Intermediate Slot Drill	14.98	83	26	12
D1499BPL	£103.47	14.99mm HSS 3-Flute Intermediate Slot Drill	14.99	83	26	12
D1500BPL	£103.47	15mm HSS 3-Flute Intermediate Slot Drill	15.00	83	26	12
D1501BPL	£103.47	15.01mm HSS 3-Flute Intermediate Slot Drill	15.01	92	32	16
D1502BPL	£103.47	15.02mm HSS 3-Flute Intermediate Slot Drill	15.02	92	32	16
D1503BPL	£103.47	15.03mm HSS 3-Flute Intermediate Slot Drill	15.03	92	32	16
D1504BPL	£103.47	15.04mm HSS 3-Flute Intermediate Slot Drill	15.04	92	32	16
D1505BPL	£103.47	15.05mm HSS 3-Flute Intermediate Slot Drill	15.05	92	32	16
D1506BPL	£103.47	15.06mm HSS 3-Flute Intermediate Slot Drill	15.06	92	32	16
D1507BPL	£103.47	15.07mm HSS 3-Flute Intermediate Slot Drill	15.07	92	32	16
D1508BPL	£103.47	15.08mm HSS 3-Flute Intermediate Slot Drill	15.08	92	32	16
D1509BPL	£103.47	15.09mm HSS 3-Flute Intermediate Slot Drill	15.09	92	32	16
D1510BPL	£103.47	15.1mm HSS 3-Flute Intermediate Slot Drill	15.10	92	32	16
D1511BPL	£103.47	15.11mm HSS 3-Flute Intermediate Slot Drill	15.11	92	32	16
D1512BPL	£103.47	15.12mm HSS 3-Flute Intermediate Slot Drill	15.12	92	32	16
D1513BPL	£103.47	15.13mm HSS 3-Flute Intermediate Slot Drill	15.13	92	32	16

(Prices do not include VAT)

SLOT DRILLS & END MILLS

3 Flute Intermediate Slot Drills

Supplied by Leclerc

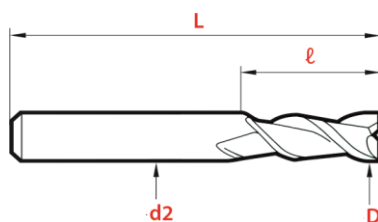

HSS M42 8% Cob

Tolerance			
D	L	ℓ	d2
-0.01	±1	+1	h6

Product Code	Price	Description	D	L	ℓ	d2
D1514BPL	£103.47	15.14mm HSS 3-Flute Intermediate Slot Drill	15.14	92	32	16
D1515BPL	£103.47	15.15mm HSS 3-Flute Intermediate Slot Drill	15.15	92	32	16
D1516BPL	£103.47	15.16mm HSS 3-Flute Intermediate Slot Drill	15.16	92	32	16
D1517BPL	£103.47	15.17mm HSS 3-Flute Intermediate Slot Drill	15.17	92	32	16
D1518BPL	£103.47	15.18mm HSS 3-Flute Intermediate Slot Drill	15.18	92	32	16
D1519BPL	£103.47	15.19mm HSS 3-Flute Intermediate Slot Drill	15.19	92	32	16
D1520BPL	£103.47	15.2mm HSS 3-Flute Intermediate Slot Drill	15.20	92	32	16
D1521BPL	£103.47	15.21mm HSS 3-Flute Intermediate Slot Drill	15.21	92	32	16
D1522BPL	£103.47	15.22mm HSS 3-Flute Intermediate Slot Drill	15.22	92	32	16
D1523BPL	£103.47	15.23mm HSS 3-Flute Intermediate Slot Drill	15.23	92	32	16
D1524BPL	£103.47	15.24mm HSS 3-Flute Intermediate Slot Drill	15.24	92	32	16
D1525BPL	£103.47	15.25mm HSS 3-Flute Intermediate Slot Drill	15.25	92	32	16
D1526BPL	£103.47	15.26mm HSS 3-Flute Intermediate Slot Drill	15.26	92	32	16
D1527BPL	£103.47	15.27mm HSS 3-Flute Intermediate Slot Drill	15.27	92	32	16
D1528BPL	£103.47	15.28mm HSS 3-Flute Intermediate Slot Drill	15.28	92	32	16
D1529BPL	£103.47	15.29mm HSS 3-Flute Intermediate Slot Drill	15.29	92	32	16
D1530BPL	£103.47	15.3mm HSS 3-Flute Intermediate Slot Drill	15.30	92	32	16
D1531BPL	£103.47	15.31mm HSS 3-Flute Intermediate Slot Drill	15.31	92	32	16
D1532BPL	£103.47	15.32mm HSS 3-Flute Intermediate Slot Drill	15.32	92	32	16
D1533BPL	£103.47	15.33mm HSS 3-Flute Intermediate Slot Drill	15.33	92	32	16
D1534BPL	£103.47	15.34mm HSS 3-Flute Intermediate Slot Drill	15.34	92	32	16
D1535BPL	£103.47	15.35mm HSS 3-Flute Intermediate Slot Drill	15.35	92	32	16
D1536BPL	£103.47	15.36mm HSS 3-Flute Intermediate Slot Drill	15.36	92	32	16
D1537BPL	£103.47	15.37mm HSS 3-Flute Intermediate Slot Drill	15.37	92	32	16
D1538BPL	£103.47	15.38mm HSS 3-Flute Intermediate Slot Drill	15.38	92	32	16
D1539BPL	£103.47	15.39mm HSS 3-Flute Intermediate Slot Drill	15.39	92	32	16
D1540BPL	£103.47	15.4mm HSS 3-Flute Intermediate Slot Drill	15.40	92	32	16
D1541BPL	£103.47	15.41mm HSS 3-Flute Intermediate Slot Drill	15.41	92	32	16
D1542BPL	£103.47	15.42mm HSS 3-Flute Intermediate Slot Drill	15.42	92	32	16
D1543BPL	£103.47	15.43mm HSS 3-Flute Intermediate Slot Drill	15.43	92	32	16
D1544BPL	£103.47	15.44mm HSS 3-Flute Intermediate Slot Drill	15.44	92	32	16
D1545BPL	£103.47	15.45mm HSS 3-Flute Intermediate Slot Drill	15.45	92	32	16
D1546BPL	£103.47	15.46mm HSS 3-Flute Intermediate Slot Drill	15.46	92	32	16
D1547BPL	£103.47	15.47mm HSS 3-Flute Intermediate Slot Drill	15.47	92	32	16
D1548BPL	£103.47	15.48mm HSS 3-Flute Intermediate Slot Drill	15.48	92	32	16
D1549BPL	£103.47	15.49mm HSS 3-Flute Intermediate Slot Drill	15.49	92	32	16
D1550BPL	£103.47	15.5mm HSS 3-Flute Intermediate Slot Drill	15.50	92	32	16
D1551BPL	£103.47	15.51mm HSS 3-Flute Intermediate Slot Drill	15.51	92	32	16
D1552BPL	£103.47	15.52mm HSS 3-Flute Intermediate Slot Drill	15.52	92	32	16
D1553BPL	£103.47	15.53mm HSS 3-Flute Intermediate Slot Drill	15.53	92	32	16
D1554BPL	£103.47	15.54mm HSS 3-Flute Intermediate Slot Drill	15.54	92	32	16
D1555BPL	£103.47	15.55mm HSS 3-Flute Intermediate Slot Drill	15.55	92	32	16
D1556BPL	£103.47	15.56mm HSS 3-Flute Intermediate Slot Drill	15.56	92	32	16
D1557BPL	£103.47	15.57mm HSS 3-Flute Intermediate Slot Drill	15.57	92	32	16

(Prices do not include VAT)

SLOT DRILLS & END MILLS
3 Flute Intermediate Slot Drills
 Supplied by Leclerc

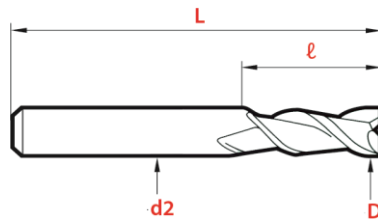

HSS M42 8% Cob

Tolerance			
D	L	ℓ	d2
-0.01	±1	+1	h6

Product Code	Price	Description	D	L	ℓ	d2
D1558BPL	£103.47	15.58mm HSS 3-Flute Intermediate Slot Drill	15.58	92	32	16
D1559BPL	£103.47	15.59mm HSS 3-Flute Intermediate Slot Drill	15.59	92	32	16
D1560BPL	£103.47	15.6mm HSS 3-Flute Intermediate Slot Drill	15.60	92	32	16
D1561BPL	£103.47	15.61mm HSS 3-Flute Intermediate Slot Drill	15.61	92	32	16
D1562BPL	£103.47	15.62mm HSS 3-Flute Intermediate Slot Drill	15.62	92	32	16
D1563BPL	£103.47	15.63mm HSS 3-Flute Intermediate Slot Drill	15.63	92	32	16
D1564BPL	£103.47	15.64mm HSS 3-Flute Intermediate Slot Drill	15.64	92	32	16
D1565BPL	£103.47	15.65mm HSS 3-Flute Intermediate Slot Drill	15.65	92	32	16
D1566BPL	£103.47	15.66mm HSS 3-Flute Intermediate Slot Drill	15.66	92	32	16
D1567BPL	£103.47	15.67mm HSS 3-Flute Intermediate Slot Drill	15.67	92	32	16
D1568BPL	£103.47	15.68mm HSS 3-Flute Intermediate Slot Drill	15.68	92	32	16
D1569BPL	£103.47	15.69mm HSS 3-Flute Intermediate Slot Drill	15.69	92	32	16
D1570BPL	£103.47	15.7mm HSS 3-Flute Intermediate Slot Drill	15.70	92	32	16
D1571BPL	£103.47	15.71mm HSS 3-Flute Intermediate Slot Drill	15.71	92	32	16
D1572BPL	£103.47	15.72mm HSS 3-Flute Intermediate Slot Drill	15.72	92	32	16
D1573BPL	£103.47	15.73mm HSS 3-Flute Intermediate Slot Drill	15.73	92	32	16
D1574BPL	£103.47	15.74mm HSS 3-Flute Intermediate Slot Drill	15.74	92	32	16
D1575BPL	£103.47	15.75mm HSS 3-Flute Intermediate Slot Drill	15.75	92	32	16
D1576BPL	£103.47	15.76mm HSS 3-Flute Intermediate Slot Drill	15.76	92	32	16
D1577BPL	£103.47	15.77mm HSS 3-Flute Intermediate Slot Drill	15.77	92	32	16
D1578BPL	£103.47	15.78mm HSS 3-Flute Intermediate Slot Drill	15.78	92	32	16
D1579BPL	£103.47	15.79mm HSS 3-Flute Intermediate Slot Drill	15.79	92	32	16
D1580BPL	£103.47	15.8mm HSS 3-Flute Intermediate Slot Drill	15.80	92	32	16
D1581BPL	£103.47	15.81mm HSS 3-Flute Intermediate Slot Drill	15.81	92	32	16
D1582BPL	£103.47	15.82mm HSS 3-Flute Intermediate Slot Drill	15.82	92	32	16
D1583BPL	£103.47	15.83mm HSS 3-Flute Intermediate Slot Drill	15.83	92	32	16
D1584BPL	£103.47	15.84mm HSS 3-Flute Intermediate Slot Drill	15.84	92	32	16
D1585BPL	£103.47	15.85mm HSS 3-Flute Intermediate Slot Drill	15.85	92	32	16
D1586BPL	£103.47	15.86mm HSS 3-Flute Intermediate Slot Drill	15.86	92	32	16
D1587BPL	£103.47	15.87mm HSS 3-Flute Intermediate Slot Drill	15.87	92	32	16
D1588BPL	£103.47	15.88mm HSS 3-Flute Intermediate Slot Drill	15.88	92	32	16
D1589BPL	£103.47	15.89mm HSS 3-Flute Intermediate Slot Drill	15.89	92	32	16
D1590BPL	£103.47	15.9mm HSS 3-Flute Intermediate Slot Drill	15.90	92	32	16
D1591BPL	£103.47	15.91mm HSS 3-Flute Intermediate Slot Drill	15.91	92	32	16
D1592BPL	£103.47	15.92mm HSS 3-Flute Intermediate Slot Drill	15.92	92	32	16
D1593BPL	£103.47	15.93mm HSS 3-Flute Intermediate Slot Drill	15.93	92	32	16
D1594BPL	£103.47	15.94mm HSS 3-Flute Intermediate Slot Drill	15.94	92	32	16
D1595BPL	£103.47	15.95mm HSS 3-Flute Intermediate Slot Drill	15.95	92	32	16
D1596BPL	£103.47	15.96mm HSS 3-Flute Intermediate Slot Drill	15.96	92	32	16
D1597BPL	£103.47	15.97mm HSS 3-Flute Intermediate Slot Drill	15.97	92	32	16
D1598BPL	£103.47	15.98mm HSS 3-Flute Intermediate Slot Drill	15.98	92	32	16
D1599BPL	£103.47	15.99mm HSS 3-Flute Intermediate Slot Drill	15.99	92	32	16
D1600BPL	£103.47	16mm HSS 3-Flute Intermediate Slot Drill	16.00	92	32	16
D1601BPL	£103.47	16.01mm HSS 3-Flute Intermediate Slot Drill	16.01	92	32	16

(Prices do not include VAT)

SLOT DRILLS & END MILLS

3 Flute Intermediate Slot Drills

Supplied by Leclerc

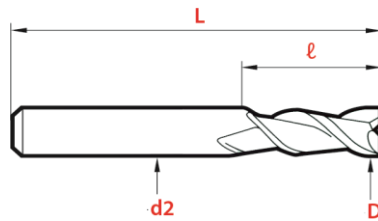

HSS M42 8% Cob

Tolerance			
D	L	l	d2
-0.01	±1	+1	h6

Product Code	Price	Description	D	L	l	d2
D1602BPL	£103.47	16.02mm HSS 3-Flute Intermediate Slot Drill	16.02	92	32	16
D1603BPL	£103.47	16.03mm HSS 3-Flute Intermediate Slot Drill	16.03	92	32	16
D1604BPL	£103.47	16.04mm HSS 3-Flute Intermediate Slot Drill	16.04	92	32	16
D1605BPL	£103.47	16.05mm HSS 3-Flute Intermediate Slot Drill	16.05	92	32	16
D1606BPL	£103.47	16.06mm HSS 3-Flute Intermediate Slot Drill	16.06	92	32	16
D1607BPL	£103.47	16.07mm HSS 3-Flute Intermediate Slot Drill	16.07	92	32	16
D1608BPL	£103.47	16.08mm HSS 3-Flute Intermediate Slot Drill	16.08	92	32	16
D1609BPL	£103.47	16.09mm HSS 3-Flute Intermediate Slot Drill	16.09	92	32	16
D1610BPL	£103.47	16.1mm HSS 3-Flute Intermediate Slot Drill	16.10	92	32	16
D1611BPL	£103.47	16.11mm HSS 3-Flute Intermediate Slot Drill	16.11	92	32	16
D1612BPL	£103.47	16.12mm HSS 3-Flute Intermediate Slot Drill	16.12	92	32	16
D1613BPL	£103.47	16.13mm HSS 3-Flute Intermediate Slot Drill	16.13	92	32	16
D1614BPL	£103.47	16.14mm HSS 3-Flute Intermediate Slot Drill	16.14	92	32	16
D1615BPL	£103.47	16.15mm HSS 3-Flute Intermediate Slot Drill	16.15	92	32	16
D1616BPL	£103.47	16.16mm HSS 3-Flute Intermediate Slot Drill	16.16	92	32	16
D1617BPL	£103.47	16.17mm HSS 3-Flute Intermediate Slot Drill	16.17	92	32	16
D1618BPL	£103.47	16.18mm HSS 3-Flute Intermediate Slot Drill	16.18	92	32	16
D1619BPL	£103.47	16.19mm HSS 3-Flute Intermediate Slot Drill	16.19	92	32	16
D1620BPL	£103.47	16.2mm HSS 3-Flute Intermediate Slot Drill	16.20	92	32	16
D1621BPL	£103.47	16.21mm HSS 3-Flute Intermediate Slot Drill	16.21	92	32	16
D1622BPL	£103.47	16.22mm HSS 3-Flute Intermediate Slot Drill	16.22	92	32	16
D1623BPL	£103.47	16.23mm HSS 3-Flute Intermediate Slot Drill	16.23	92	32	16
D1624BPL	£103.47	16.24mm HSS 3-Flute Intermediate Slot Drill	16.24	92	32	16
D1625BPL	£103.47	16.25mm HSS 3-Flute Intermediate Slot Drill	16.25	92	32	16
D1626BPL	£103.47	16.26mm HSS 3-Flute Intermediate Slot Drill	16.26	92	32	16
D1627BPL	£103.47	16.27mm HSS 3-Flute Intermediate Slot Drill	16.27	92	32	16
D1628BPL	£103.47	16.28mm HSS 3-Flute Intermediate Slot Drill	16.28	92	32	16
D1629BPL	£103.47	16.29mm HSS 3-Flute Intermediate Slot Drill	16.29	92	32	16
D1630BPL	£103.47	16.3mm HSS 3-Flute Intermediate Slot Drill	16.30	92	32	16
D1631BPL	£103.47	16.31mm HSS 3-Flute Intermediate Slot Drill	16.31	92	32	16
D1632BPL	£103.47	16.32mm HSS 3-Flute Intermediate Slot Drill	16.32	92	32	16
D1633BPL	£103.47	16.33mm HSS 3-Flute Intermediate Slot Drill	16.33	92	32	16
D1634BPL	£103.47	16.34mm HSS 3-Flute Intermediate Slot Drill	16.34	92	32	16
D1635BPL	£103.47	16.35mm HSS 3-Flute Intermediate Slot Drill	16.35	92	32	16
D1636BPL	£103.47	16.36mm HSS 3-Flute Intermediate Slot Drill	16.36	92	32	16
D1637BPL	£103.47	16.37mm HSS 3-Flute Intermediate Slot Drill	16.37	92	32	16
D1638BPL	£103.47	16.38mm HSS 3-Flute Intermediate Slot Drill	16.38	92	32	16
D1639BPL	£103.47	16.39mm HSS 3-Flute Intermediate Slot Drill	16.39	92	32	16
D1640BPL	£103.47	16.4mm HSS 3-Flute Intermediate Slot Drill	16.40	92	32	16
D1641BPL	£103.47	16.41mm HSS 3-Flute Intermediate Slot Drill	16.41	92	32	16
D1642BPL	£103.47	16.42mm HSS 3-Flute Intermediate Slot Drill	16.42	92	32	16
D1643BPL	£103.47	16.43mm HSS 3-Flute Intermediate Slot Drill	16.43	92	32	16
D1644BPL	£103.47	16.44mm HSS 3-Flute Intermediate Slot Drill	16.44	92	32	16
D1645BPL	£103.47	16.45mm HSS 3-Flute Intermediate Slot Drill	16.45	92	32	16

(Prices do not include VAT)

SLOT DRILLS & END MILLS
3 Flute Intermediate Slot Drills
 Supplied by Leclerc

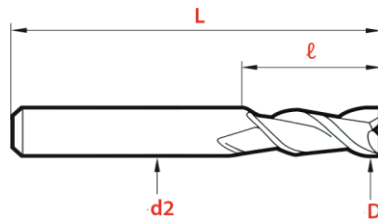

HSS M42 8% Cob

Tolerance			
D	L	ℓ	d2
-0.01	±1	+1	h6

Product Code	Price	Description	D	L	ℓ	d2
D1646BPL	£103.47	16.46mm HSS 3-Flute Intermediate Slot Drill	16.46	92	32	16
D1647BPL	£103.47	16.47mm HSS 3-Flute Intermediate Slot Drill	16.47	92	32	16
D1648BPL	£103.47	16.48mm HSS 3-Flute Intermediate Slot Drill	16.48	92	32	16
D1649BPL	£103.47	16.49mm HSS 3-Flute Intermediate Slot Drill	16.49	92	32	16
D1650BPL	£103.47	16.5mm HSS 3-Flute Intermediate Slot Drill	16.50	92	32	16
D1651BPL	£103.47	16.51mm HSS 3-Flute Intermediate Slot Drill	16.51	92	32	16
D1652BPL	£103.47	16.52mm HSS 3-Flute Intermediate Slot Drill	16.52	92	32	16
D1653BPL	£103.47	16.53mm HSS 3-Flute Intermediate Slot Drill	16.53	92	32	16
D1654BPL	£103.47	16.54mm HSS 3-Flute Intermediate Slot Drill	16.54	92	32	16
D1655BPL	£103.47	16.55mm HSS 3-Flute Intermediate Slot Drill	16.55	92	32	16
D1656BPL	£103.47	16.56mm HSS 3-Flute Intermediate Slot Drill	16.56	92	32	16
D1657BPL	£103.47	16.57mm HSS 3-Flute Intermediate Slot Drill	16.57	92	32	16
D1658BPL	£103.47	16.58mm HSS 3-Flute Intermediate Slot Drill	16.58	92	32	16
D1659BPL	£103.47	16.59mm HSS 3-Flute Intermediate Slot Drill	16.59	92	32	16
D1660BPL	£103.47	16.6mm HSS 3-Flute Intermediate Slot Drill	16.60	92	32	16
D1661BPL	£103.47	16.61mm HSS 3-Flute Intermediate Slot Drill	16.61	92	32	16
D1662BPL	£103.47	16.62mm HSS 3-Flute Intermediate Slot Drill	16.62	92	32	16
D1663BPL	£103.47	16.63mm HSS 3-Flute Intermediate Slot Drill	16.63	92	32	16
D1664BPL	£103.47	16.64mm HSS 3-Flute Intermediate Slot Drill	16.64	92	32	16
D1665BPL	£103.47	16.65mm HSS 3-Flute Intermediate Slot Drill	16.65	92	32	16
D1666BPL	£103.47	16.66mm HSS 3-Flute Intermediate Slot Drill	16.66	92	32	16
D1667BPL	£103.47	16.67mm HSS 3-Flute Intermediate Slot Drill	16.67	92	32	16
D1668BPL	£103.47	16.68mm HSS 3-Flute Intermediate Slot Drill	16.68	92	32	16
D1669BPL	£103.47	16.69mm HSS 3-Flute Intermediate Slot Drill	16.69	92	32	16
D1670BPL	£103.47	16.7mm HSS 3-Flute Intermediate Slot Drill	16.70	92	32	16
D1671BPL	£103.47	16.71mm HSS 3-Flute Intermediate Slot Drill	16.71	92	32	16
D1672BPL	£103.47	16.72mm HSS 3-Flute Intermediate Slot Drill	16.72	92	32	16
D1673BPL	£103.47	16.73mm HSS 3-Flute Intermediate Slot Drill	16.73	92	32	16
D1674BPL	£103.47	16.74mm HSS 3-Flute Intermediate Slot Drill	16.74	92	32	16
D1675BPL	£103.47	16.75mm HSS 3-Flute Intermediate Slot Drill	16.75	92	32	16
D1676BPL	£103.47	16.76mm HSS 3-Flute Intermediate Slot Drill	16.76	92	32	16
D1677BPL	£103.47	16.77mm HSS 3-Flute Intermediate Slot Drill	16.77	92	32	16
D1678BPL	£103.47	16.78mm HSS 3-Flute Intermediate Slot Drill	16.78	92	32	16
D1679BPL	£103.47	16.79mm HSS 3-Flute Intermediate Slot Drill	16.79	92	32	16
D1680BPL	£103.47	16.8mm HSS 3-Flute Intermediate Slot Drill	16.80	92	32	16
D1681BPL	£103.47	16.81mm HSS 3-Flute Intermediate Slot Drill	16.81	92	32	16
D1682BPL	£103.47	16.82mm HSS 3-Flute Intermediate Slot Drill	16.82	92	32	16
D1683BPL	£103.47	16.83mm HSS 3-Flute Intermediate Slot Drill	16.83	92	32	16
D1684BPL	£103.47	16.84mm HSS 3-Flute Intermediate Slot Drill	16.84	92	32	16
D1685BPL	£103.47	16.85mm HSS 3-Flute Intermediate Slot Drill	16.85	92	32	16
D1686BPL	£103.47	16.86mm HSS 3-Flute Intermediate Slot Drill	16.86	92	32	16
D1687BPL	£103.47	16.87mm HSS 3-Flute Intermediate Slot Drill	16.87	92	32	16
D1688BPL	£103.47	16.88mm HSS 3-Flute Intermediate Slot Drill	16.88	92	32	16
D1689BPL	£103.47	16.89mm HSS 3-Flute Intermediate Slot Drill	16.89	92	32	16

(Prices do not include VAT)

SLOT DRILLS & END MILLS
3 Flute Intermediate Slot Drills
Supplied by Leclerc

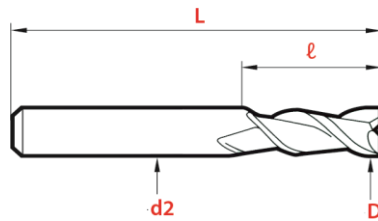

HSS M42 8% Cob

Tolerance			
D	L	ℓ	d2
-0.01	±1	+1	h6

Product Code	Price	Description	D	L	ℓ	d2
D1690BPL	£103.47	16.9mm HSS 3-Flute Intermediate Slot Drill	16.90	92	32	16
D1691BPL	£103.47	16.91mm HSS 3-Flute Intermediate Slot Drill	16.91	92	32	16
D1692BPL	£103.47	16.92mm HSS 3-Flute Intermediate Slot Drill	16.92	92	32	16
D1693BPL	£103.47	16.93mm HSS 3-Flute Intermediate Slot Drill	16.93	92	32	16
D1694BPL	£103.47	16.94mm HSS 3-Flute Intermediate Slot Drill	16.94	92	32	16
D1695BPL	£103.47	16.95mm HSS 3-Flute Intermediate Slot Drill	16.95	92	32	16
D1696BPL	£103.47	16.96mm HSS 3-Flute Intermediate Slot Drill	16.96	92	32	16
D1697BPL	£103.47	16.97mm HSS 3-Flute Intermediate Slot Drill	16.97	92	32	16
D1698BPL	£103.47	16.98mm HSS 3-Flute Intermediate Slot Drill	16.98	92	32	16
D1699BPL	£103.47	16.99mm HSS 3-Flute Intermediate Slot Drill	16.99	92	32	16
D1700BPL	£103.47	17mm HSS 3-Flute Intermediate Slot Drill	17.00	92	32	16
D1701BPL	£103.47	17.01mm HSS 3-Flute Intermediate Slot Drill	17.01	92	32	16
D1702BPL	£103.47	17.02mm HSS 3-Flute Intermediate Slot Drill	17.02	92	32	16
D1703BPL	£103.47	17.03mm HSS 3-Flute Intermediate Slot Drill	17.03	92	32	16
D1704BPL	£103.47	17.04mm HSS 3-Flute Intermediate Slot Drill	17.04	92	32	16
D1705BPL	£103.47	17.05mm HSS 3-Flute Intermediate Slot Drill	17.05	92	32	16
D1706BPL	£103.47	17.06mm HSS 3-Flute Intermediate Slot Drill	17.06	92	32	16
D1707BPL	£103.47	17.07mm HSS 3-Flute Intermediate Slot Drill	17.07	92	32	16
D1708BPL	£103.47	17.08mm HSS 3-Flute Intermediate Slot Drill	17.08	92	32	16
D1709BPL	£103.47	17.09mm HSS 3-Flute Intermediate Slot Drill	17.09	92	32	16
D1710BPL	£103.47	17.1mm HSS 3-Flute Intermediate Slot Drill	17.10	92	32	16
D1711BPL	£103.47	17.11mm HSS 3-Flute Intermediate Slot Drill	17.11	92	32	16
D1712BPL	£103.47	17.12mm HSS 3-Flute Intermediate Slot Drill	17.12	92	32	16
D1713BPL	£103.47	17.13mm HSS 3-Flute Intermediate Slot Drill	17.13	92	32	16
D1714BPL	£103.47	17.14mm HSS 3-Flute Intermediate Slot Drill	17.14	92	32	16
D1715BPL	£103.47	17.15mm HSS 3-Flute Intermediate Slot Drill	17.15	92	32	16
D1716BPL	£103.47	17.16mm HSS 3-Flute Intermediate Slot Drill	17.16	92	32	16
D1717BPL	£103.47	17.17mm HSS 3-Flute Intermediate Slot Drill	17.17	92	32	16
D1718BPL	£103.47	17.18mm HSS 3-Flute Intermediate Slot Drill	17.18	92	32	16
D1719BPL	£103.47	17.19mm HSS 3-Flute Intermediate Slot Drill	17.19	92	32	16
D1720BPL	£103.47	17.2mm HSS 3-Flute Intermediate Slot Drill	17.20	92	32	16
D1721BPL	£103.47	17.21mm HSS 3-Flute Intermediate Slot Drill	17.21	92	32	16
D1722BPL	£103.47	17.22mm HSS 3-Flute Intermediate Slot Drill	17.22	92	32	16
D1723BPL	£103.47	17.23mm HSS 3-Flute Intermediate Slot Drill	17.23	92	32	16
D1724BPL	£103.47	17.24mm HSS 3-Flute Intermediate Slot Drill	17.24	92	32	16
D1725BPL	£103.47	17.25mm HSS 3-Flute Intermediate Slot Drill	17.25	92	32	16
D1726BPL	£103.47	17.26mm HSS 3-Flute Intermediate Slot Drill	17.26	92	32	16
D1727BPL	£103.47	17.27mm HSS 3-Flute Intermediate Slot Drill	17.27	92	32	16
D1728BPL	£103.47	17.28mm HSS 3-Flute Intermediate Slot Drill	17.28	92	32	16
D1729BPL	£103.47	17.29mm HSS 3-Flute Intermediate Slot Drill	17.29	92	32	16
D1730BPL	£103.47	17.3mm HSS 3-Flute Intermediate Slot Drill	17.30	92	32	16
D1731BPL	£103.47	17.31mm HSS 3-Flute Intermediate Slot Drill	17.31	92	32	16
D1732BPL	£103.47	17.32mm HSS 3-Flute Intermediate Slot Drill	17.32	92	32	16
D1733BPL	£103.47	17.33mm HSS 3-Flute Intermediate Slot Drill	17.33	92	32	16

(Prices do not include VAT)

SLOT DRILLS & END MILLS
3 Flute Intermediate Slot Drills
 Supplied by Leclerc

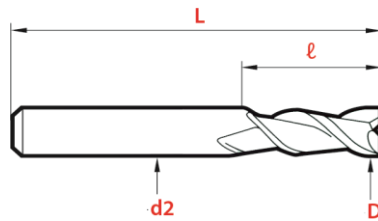

Tolerance			
D	L	ℓ	d2
-0.01	±1	+1	h6

HSS M42 8% Cob

Product Code	Price	Description	D	L	ℓ	d2
D1734BPL	£103.47	17.34mm HSS 3-Flute Intermediate Slot Drill	17.34	92	32	16
D1735BPL	£103.47	17.35mm HSS 3-Flute Intermediate Slot Drill	17.35	92	32	16
D1736BPL	£103.47	17.36mm HSS 3-Flute Intermediate Slot Drill	17.36	92	32	16
D1737BPL	£103.47	17.37mm HSS 3-Flute Intermediate Slot Drill	17.37	92	32	16
D1738BPL	£103.47	17.38mm HSS 3-Flute Intermediate Slot Drill	17.38	92	32	16
D1739BPL	£103.47	17.39mm HSS 3-Flute Intermediate Slot Drill	17.39	92	32	16
D1740BPL	£103.47	17.4mm HSS 3-Flute Intermediate Slot Drill	17.40	92	32	16
D1741BPL	£103.47	17.41mm HSS 3-Flute Intermediate Slot Drill	17.41	92	32	16
D1742BPL	£103.47	17.42mm HSS 3-Flute Intermediate Slot Drill	17.42	92	32	16
D1743BPL	£103.47	17.43mm HSS 3-Flute Intermediate Slot Drill	17.43	92	32	16
D1744BPL	£103.47	17.44mm HSS 3-Flute Intermediate Slot Drill	17.44	92	32	16
D1745BPL	£103.47	17.45mm HSS 3-Flute Intermediate Slot Drill	17.45	92	32	16
D1746BPL	£103.47	17.46mm HSS 3-Flute Intermediate Slot Drill	17.46	92	32	16
D1747BPL	£103.47	17.47mm HSS 3-Flute Intermediate Slot Drill	17.47	92	32	16
D1748BPL	£103.47	17.48mm HSS 3-Flute Intermediate Slot Drill	17.48	92	32	16
D1749BPL	£103.47	17.49mm HSS 3-Flute Intermediate Slot Drill	17.49	92	32	16
D1750BPL	£103.47	17.5mm HSS 3-Flute Intermediate Slot Drill	17.50	92	32	16
D1751BPL	£103.47	17.51mm HSS 3-Flute Intermediate Slot Drill	17.51	92	32	16
D1752BPL	£103.47	17.52mm HSS 3-Flute Intermediate Slot Drill	17.52	92	32	16
D1753BPL	£103.47	17.53mm HSS 3-Flute Intermediate Slot Drill	17.53	92	32	16
D1754BPL	£103.47	17.54mm HSS 3-Flute Intermediate Slot Drill	17.54	92	32	16
D1755BPL	£103.47	17.55mm HSS 3-Flute Intermediate Slot Drill	17.55	92	32	16
D1756BPL	£103.47	17.56mm HSS 3-Flute Intermediate Slot Drill	17.56	92	32	16
D1757BPL	£103.47	17.57mm HSS 3-Flute Intermediate Slot Drill	17.57	92	32	16
D1758BPL	£103.47	17.58mm HSS 3-Flute Intermediate Slot Drill	17.58	92	32	16
D1759BPL	£103.47	17.59mm HSS 3-Flute Intermediate Slot Drill	17.59	92	32	16
D1760BPL	£103.47	17.6mm HSS 3-Flute Intermediate Slot Drill	17.60	92	32	16
D1761BPL	£103.47	17.61mm HSS 3-Flute Intermediate Slot Drill	17.61	92	32	16
D1762BPL	£103.47	17.62mm HSS 3-Flute Intermediate Slot Drill	17.62	92	32	16
D1763BPL	£103.47	17.63mm HSS 3-Flute Intermediate Slot Drill	17.63	92	32	16
D1764BPL	£103.47	17.64mm HSS 3-Flute Intermediate Slot Drill	17.64	92	32	16
D1765BPL	£103.47	17.65mm HSS 3-Flute Intermediate Slot Drill	17.65	92	32	16
D1766BPL	£103.47	17.66mm HSS 3-Flute Intermediate Slot Drill	17.66	92	32	16
D1767BPL	£103.47	17.67mm HSS 3-Flute Intermediate Slot Drill	17.67	92	32	16
D1768BPL	£103.47	17.68mm HSS 3-Flute Intermediate Slot Drill	17.68	92	32	16
D1769BPL	£103.47	17.69mm HSS 3-Flute Intermediate Slot Drill	17.69	92	32	16
D1770BPL	£103.47	17.7mm HSS 3-Flute Intermediate Slot Drill	17.70	92	32	16
D1771BPL	£103.47	17.71mm HSS 3-Flute Intermediate Slot Drill	17.71	92	32	16
D1772BPL	£103.47	17.72mm HSS 3-Flute Intermediate Slot Drill	17.72	92	32	16
D1773BPL	£103.47	17.73mm HSS 3-Flute Intermediate Slot Drill	17.73	92	32	16
D1774BPL	£103.47	17.74mm HSS 3-Flute Intermediate Slot Drill	17.74	92	32	16
D1775BPL	£103.47	17.75mm HSS 3-Flute Intermediate Slot Drill	17.75	92	32	16
D1776BPL	£103.47	17.76mm HSS 3-Flute Intermediate Slot Drill	17.76	92	32	16
D1777BPL	£103.47	17.77mm HSS 3-Flute Intermediate Slot Drill	17.77	92	32	16

(Prices do not include VAT)

SLOT DRILLS & END MILLS
3 Flute Intermediate Slot Drills
 Supplied by Leclerc

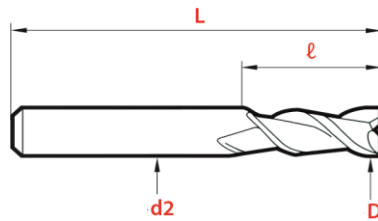

HSS M42 8% Cob

Tolerance			
D	L	ℓ	d2
-0.01	±1	+1	h6

Product Code	Price	Description	D	L	ℓ	d2
D1778BPL	£103.47	17.78mm HSS 3-Flute Intermediate Slot Drill	17.78	92	32	16
D1779BPL	£103.47	17.79mm HSS 3-Flute Intermediate Slot Drill	17.79	92	32	16
D1780BPL	£103.47	17.8mm HSS 3-Flute Intermediate Slot Drill	17.80	92	32	16
D1781BPL	£103.47	17.81mm HSS 3-Flute Intermediate Slot Drill	17.81	92	32	16
D1782BPL	£103.47	17.82mm HSS 3-Flute Intermediate Slot Drill	17.82	92	32	16
D1783BPL	£103.47	17.83mm HSS 3-Flute Intermediate Slot Drill	17.83	92	32	16
D1784BPL	£103.47	17.84mm HSS 3-Flute Intermediate Slot Drill	17.84	92	32	16
D1785BPL	£103.47	17.85mm HSS 3-Flute Intermediate Slot Drill	17.85	92	32	16
D1786BPL	£103.47	17.86mm HSS 3-Flute Intermediate Slot Drill	17.86	92	32	16
D1787BPL	£103.47	17.87mm HSS 3-Flute Intermediate Slot Drill	17.87	92	32	16
D1788BPL	£103.47	17.88mm HSS 3-Flute Intermediate Slot Drill	17.88	92	32	16
D1789BPL	£103.47	17.89mm HSS 3-Flute Intermediate Slot Drill	17.89	92	32	16
D1790BPL	£103.47	17.9mm HSS 3-Flute Intermediate Slot Drill	17.90	92	32	16
D1791BPL	£103.47	17.91mm HSS 3-Flute Intermediate Slot Drill	17.91	92	32	16
D1792BPL	£103.47	17.92mm HSS 3-Flute Intermediate Slot Drill	17.92	92	32	16
D1793BPL	£103.47	17.93mm HSS 3-Flute Intermediate Slot Drill	17.93	92	32	16
D1794BPL	£103.47	17.94mm HSS 3-Flute Intermediate Slot Drill	17.94	92	32	16
D1795BPL	£103.47	17.95mm HSS 3-Flute Intermediate Slot Drill	17.95	92	32	16
D1796BPL	£103.47	17.96mm HSS 3-Flute Intermediate Slot Drill	17.96	92	32	16
D1797BPL	£103.47	17.97mm HSS 3-Flute Intermediate Slot Drill	17.97	92	32	16
D1798BPL	£103.47	17.98mm HSS 3-Flute Intermediate Slot Drill	17.98	92	32	16
D1799BPL	£103.47	17.99mm HSS 3-Flute Intermediate Slot Drill	17.99	92	32	16
D1800BPL	£103.47	18mm HSS 3-Flute Intermediate Slot Drill	18.00	92	32	16
D1801BPL	£103.47	18.01mm HSS 3-Flute Intermediate Slot Drill	18.01	92	32	16
D1802BPL	£103.47	18.02mm HSS 3-Flute Intermediate Slot Drill	18.02	92	32	16
D1803BPL	£103.47	18.03mm HSS 3-Flute Intermediate Slot Drill	18.03	92	32	16
D1804BPL	£103.47	18.04mm HSS 3-Flute Intermediate Slot Drill	18.04	92	32	16
D1805BPL	£103.47	18.05mm HSS 3-Flute Intermediate Slot Drill	18.05	92	32	16
D1806BPL	£103.47	18.06mm HSS 3-Flute Intermediate Slot Drill	18.06	92	32	16
D1807BPL	£103.47	18.07mm HSS 3-Flute Intermediate Slot Drill	18.07	92	32	16
D1808BPL	£103.47	18.08mm HSS 3-Flute Intermediate Slot Drill	18.08	92	32	16
D1809BPL	£103.47	18.09mm HSS 3-Flute Intermediate Slot Drill	18.09	92	32	16
D1810BPL	£103.47	18.1mm HSS 3-Flute Intermediate Slot Drill	18.10	92	32	16
D1811BPL	£103.47	18.11mm HSS 3-Flute Intermediate Slot Drill	18.11	92	32	16
D1812BPL	£103.47	18.12mm HSS 3-Flute Intermediate Slot Drill	18.12	92	32	16
D1813BPL	£103.47	18.13mm HSS 3-Flute Intermediate Slot Drill	18.13	92	32	16
D1814BPL	£103.47	18.14mm HSS 3-Flute Intermediate Slot Drill	18.14	92	32	16
D1815BPL	£103.47	18.15mm HSS 3-Flute Intermediate Slot Drill	18.15	92	32	16
D1816BPL	£103.47	18.16mm HSS 3-Flute Intermediate Slot Drill	18.16	92	32	16
D1817BPL	£103.47	18.17mm HSS 3-Flute Intermediate Slot Drill	18.17	92	32	16
D1818BPL	£103.47	18.18mm HSS 3-Flute Intermediate Slot Drill	18.18	92	32	16
D1819BPL	£103.47	18.19mm HSS 3-Flute Intermediate Slot Drill	18.19	92	32	16
D1820BPL	£103.47	18.2mm HSS 3-Flute Intermediate Slot Drill	18.20	92	32	16
D1821BPL	£103.47	18.21mm HSS 3-Flute Intermediate Slot Drill	18.21	92	32	16

(Prices do not include VAT)

SLOT DRILLS & END MILLS
3 Flute Intermediate Slot Drills
 Supplied by Leclerc

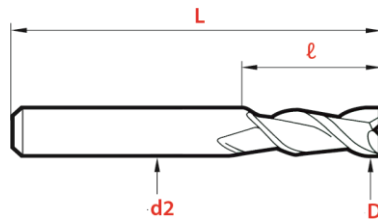

HSS M42 8% Cob

Tolerance			
D	L	ℓ	d2
-0.01	±1	+1	h6

Product Code	Price	Description	D	L	ℓ	d2
D1822BPL	£103.47	18.22mm HSS 3-Flute Intermediate Slot Drill	18.22	92	32	16
D1823BPL	£103.47	18.23mm HSS 3-Flute Intermediate Slot Drill	18.23	92	32	16
D1824BPL	£103.47	18.24mm HSS 3-Flute Intermediate Slot Drill	18.24	92	32	16
D1825BPL	£103.47	18.25mm HSS 3-Flute Intermediate Slot Drill	18.25	92	32	16
D1826BPL	£103.47	18.26mm HSS 3-Flute Intermediate Slot Drill	18.26	92	32	16
D1827BPL	£103.47	18.27mm HSS 3-Flute Intermediate Slot Drill	18.27	92	32	16
D1828BPL	£103.47	18.28mm HSS 3-Flute Intermediate Slot Drill	18.28	92	32	16
D1829BPL	£103.47	18.29mm HSS 3-Flute Intermediate Slot Drill	18.29	92	32	16
D1830BPL	£103.47	18.3mm HSS 3-Flute Intermediate Slot Drill	18.30	92	32	16
D1831BPL	£103.47	18.31mm HSS 3-Flute Intermediate Slot Drill	18.31	92	32	16
D1832BPL	£103.47	18.32mm HSS 3-Flute Intermediate Slot Drill	18.32	92	32	16
D1833BPL	£103.47	18.33mm HSS 3-Flute Intermediate Slot Drill	18.33	92	32	16
D1834BPL	£103.47	18.34mm HSS 3-Flute Intermediate Slot Drill	18.34	92	32	16
D1835BPL	£103.47	18.35mm HSS 3-Flute Intermediate Slot Drill	18.35	92	32	16
D1836BPL	£103.47	18.36mm HSS 3-Flute Intermediate Slot Drill	18.36	92	32	16
D1837BPL	£103.47	18.37mm HSS 3-Flute Intermediate Slot Drill	18.37	92	32	16
D1838BPL	£103.47	18.38mm HSS 3-Flute Intermediate Slot Drill	18.38	92	32	16
D1839BPL	£103.47	18.39mm HSS 3-Flute Intermediate Slot Drill	18.39	92	32	16
D1840BPL	£103.47	18.4mm HSS 3-Flute Intermediate Slot Drill	18.40	92	32	16
D1841BPL	£103.47	18.41mm HSS 3-Flute Intermediate Slot Drill	18.41	92	32	16
D1842BPL	£103.47	18.42mm HSS 3-Flute Intermediate Slot Drill	18.42	92	32	16
D1843BPL	£103.47	18.43mm HSS 3-Flute Intermediate Slot Drill	18.43	92	32	16
D1844BPL	£103.47	18.44mm HSS 3-Flute Intermediate Slot Drill	18.44	92	32	16
D1845BPL	£103.47	18.45mm HSS 3-Flute Intermediate Slot Drill	18.45	92	32	16
D1846BPL	£103.47	18.46mm HSS 3-Flute Intermediate Slot Drill	18.46	92	32	16
D1847BPL	£103.47	18.47mm HSS 3-Flute Intermediate Slot Drill	18.47	92	32	16
D1848BPL	£103.47	18.48mm HSS 3-Flute Intermediate Slot Drill	18.48	92	32	16
D1849BPL	£103.47	18.49mm HSS 3-Flute Intermediate Slot Drill	18.49	92	32	16
D1850BPL	£103.47	18.5mm HSS 3-Flute Intermediate Slot Drill	18.50	92	32	16
D1851BPL	£103.47	18.51mm HSS 3-Flute Intermediate Slot Drill	18.51	92	32	16
D1852BPL	£103.47	18.52mm HSS 3-Flute Intermediate Slot Drill	18.52	92	32	16
D1853BPL	£103.47	18.53mm HSS 3-Flute Intermediate Slot Drill	18.53	92	32	16
D1854BPL	£103.47	18.54mm HSS 3-Flute Intermediate Slot Drill	18.54	92	32	16
D1855BPL	£103.47	18.55mm HSS 3-Flute Intermediate Slot Drill	18.55	92	32	16
D1856BPL	£103.47	18.56mm HSS 3-Flute Intermediate Slot Drill	18.56	92	32	16
D1857BPL	£103.47	18.57mm HSS 3-Flute Intermediate Slot Drill	18.57	92	32	16
D1858BPL	£103.47	18.58mm HSS 3-Flute Intermediate Slot Drill	18.58	92	32	16
D1859BPL	£103.47	18.59mm HSS 3-Flute Intermediate Slot Drill	18.59	92	32	16
D1860BPL	£103.47	18.6mm HSS 3-Flute Intermediate Slot Drill	18.60	92	32	16
D1861BPL	£103.47	18.61mm HSS 3-Flute Intermediate Slot Drill	18.61	92	32	16
D1862BPL	£103.47	18.62mm HSS 3-Flute Intermediate Slot Drill	18.62	92	32	16
D1863BPL	£103.47	18.63mm HSS 3-Flute Intermediate Slot Drill	18.63	92	32	16
D1864BPL	£103.47	18.64mm HSS 3-Flute Intermediate Slot Drill	18.64	92	32	16
D1865BPL	£103.47	18.65mm HSS 3-Flute Intermediate Slot Drill	18.65	92	32	16

(Prices do not include VAT)

SLOT DRILLS & END MILLS
3 Flute Intermediate Slot Drills
 Supplied by Leclerc

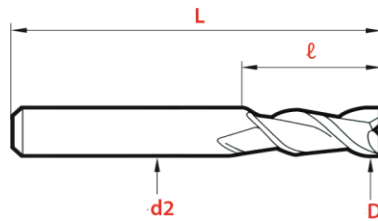

HSS M42 8% Cob

Tolerance			
D	L	ℓ	d2
-0.01	±1	+1	h6

Product Code	Price	Description	D	L	ℓ	d2
D1866BPL	£103.47	18.66mm HSS 3-Flute Intermediate Slot Drill	18.66	92	32	16
D1867BPL	£103.47	18.67mm HSS 3-Flute Intermediate Slot Drill	18.67	92	32	16
D1868BPL	£103.47	18.68mm HSS 3-Flute Intermediate Slot Drill	18.68	92	32	16
D1869BPL	£103.47	18.69mm HSS 3-Flute Intermediate Slot Drill	18.69	92	32	16
D1870BPL	£103.47	18.7mm HSS 3-Flute Intermediate Slot Drill	18.70	92	32	16
D1871BPL	£103.47	18.71mm HSS 3-Flute Intermediate Slot Drill	18.71	92	32	16
D1872BPL	£103.47	18.72mm HSS 3-Flute Intermediate Slot Drill	18.72	92	32	16
D1873BPL	£103.47	18.73mm HSS 3-Flute Intermediate Slot Drill	18.73	92	32	16
D1874BPL	£103.47	18.74mm HSS 3-Flute Intermediate Slot Drill	18.74	92	32	16
D1875BPL	£103.47	18.75mm HSS 3-Flute Intermediate Slot Drill	18.75	92	32	16
D1876BPL	£103.47	18.76mm HSS 3-Flute Intermediate Slot Drill	18.76	92	32	16
D1877BPL	£103.47	18.77mm HSS 3-Flute Intermediate Slot Drill	18.77	92	32	16
D1878BPL	£103.47	18.78mm HSS 3-Flute Intermediate Slot Drill	18.78	92	32	16
D1879BPL	£103.47	18.79mm HSS 3-Flute Intermediate Slot Drill	18.79	92	32	16
D1880BPL	£103.47	18.8mm HSS 3-Flute Intermediate Slot Drill	18.80	92	32	16
D1881BPL	£103.47	18.81mm HSS 3-Flute Intermediate Slot Drill	18.81	92	32	16
D1882BPL	£103.47	18.82mm HSS 3-Flute Intermediate Slot Drill	18.82	92	32	16
D1883BPL	£103.47	18.83mm HSS 3-Flute Intermediate Slot Drill	18.83	92	32	16
D1884BPL	£103.47	18.84mm HSS 3-Flute Intermediate Slot Drill	18.84	92	32	16
D1885BPL	£103.47	18.85mm HSS 3-Flute Intermediate Slot Drill	18.85	92	32	16
D1886BPL	£103.47	18.86mm HSS 3-Flute Intermediate Slot Drill	18.86	92	32	16
D1887BPL	£103.47	18.87mm HSS 3-Flute Intermediate Slot Drill	18.87	92	32	16
D1888BPL	£103.47	18.88mm HSS 3-Flute Intermediate Slot Drill	18.88	92	32	16
D1889BPL	£103.47	18.89mm HSS 3-Flute Intermediate Slot Drill	18.89	92	32	16
D1890BPL	£103.47	18.9mm HSS 3-Flute Intermediate Slot Drill	18.90	92	32	16
D1891BPL	£103.47	18.91mm HSS 3-Flute Intermediate Slot Drill	18.91	92	32	16
D1892BPL	£103.47	18.92mm HSS 3-Flute Intermediate Slot Drill	18.92	92	32	16
D1893BPL	£103.47	18.93mm HSS 3-Flute Intermediate Slot Drill	18.93	92	32	16
D1894BPL	£103.47	18.94mm HSS 3-Flute Intermediate Slot Drill	18.94	92	32	16
D1895BPL	£103.47	18.95mm HSS 3-Flute Intermediate Slot Drill	18.95	92	32	16
D1896BPL	£103.47	18.96mm HSS 3-Flute Intermediate Slot Drill	18.96	92	32	16
D1897BPL	£103.47	18.97mm HSS 3-Flute Intermediate Slot Drill	18.97	92	32	16
D1898BPL	£103.47	18.98mm HSS 3-Flute Intermediate Slot Drill	18.98	92	32	16
D1899BPL	£103.47	18.99mm HSS 3-Flute Intermediate Slot Drill	18.99	92	32	16
D1900BPL	£103.47	19mm HSS 3-Flute Intermediate Slot Drill	19.00	92	32	16
D1901BPL	£103.47	19.01mm HSS 3-Flute Intermediate Slot Drill	19.01	104	38	20
D1902BPL	£103.47	19.02mm HSS 3-Flute Intermediate Slot Drill	19.02	104	38	20
D1903BPL	£103.47	19.03mm HSS 3-Flute Intermediate Slot Drill	19.03	104	38	20
D1904BPL	£103.47	19.04mm HSS 3-Flute Intermediate Slot Drill	19.04	104	38	20
D1905BPL	£103.47	19.05mm HSS 3-Flute Intermediate Slot Drill	19.05	104	38	20
D1906BPL	£103.47	19.06mm HSS 3-Flute Intermediate Slot Drill	19.06	104	38	20
D1907BPL	£103.47	19.07mm HSS 3-Flute Intermediate Slot Drill	19.07	104	38	20
D1908BPL	£103.47	19.08mm HSS 3-Flute Intermediate Slot Drill	19.08	104	38	20
D1909BPL	£103.47	19.09mm HSS 3-Flute Intermediate Slot Drill	19.09	104	38	20

(Prices do not include VAT)

SLOT DRILLS & END MILLS
3 Flute Intermediate Slot Drills
 Supplied by Leclerc

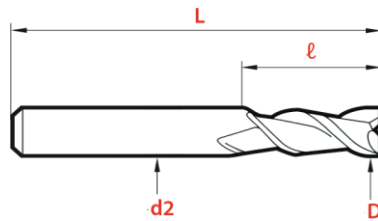

HSS M42 8% Cob

Tolerance			
D	L	ℓ	d2
-0.01	±1	+1	h6

Product Code	Price	Description	D	L	ℓ	d2
D1910BPL	£103.47	19.1mm HSS 3-Flute Intermediate Slot Drill	19.10	104	38	20
D1911BPL	£103.47	19.11mm HSS 3-Flute Intermediate Slot Drill	19.11	104	38	20
D1912BPL	£103.47	19.12mm HSS 3-Flute Intermediate Slot Drill	19.12	104	38	20
D1913BPL	£103.47	19.13mm HSS 3-Flute Intermediate Slot Drill	19.13	104	38	20
D1914BPL	£103.47	19.14mm HSS 3-Flute Intermediate Slot Drill	19.14	104	38	20
D1915BPL	£103.47	19.15mm HSS 3-Flute Intermediate Slot Drill	19.15	104	38	20
D1916BPL	£103.47	19.16mm HSS 3-Flute Intermediate Slot Drill	19.16	104	38	20
D1917BPL	£103.47	19.17mm HSS 3-Flute Intermediate Slot Drill	19.17	104	38	20
D1918BPL	£103.47	19.18mm HSS 3-Flute Intermediate Slot Drill	19.18	104	38	20
D1919BPL	£103.47	19.19mm HSS 3-Flute Intermediate Slot Drill	19.19	104	38	20
D1920BPL	£103.47	19.2mm HSS 3-Flute Intermediate Slot Drill	19.20	104	38	20
D1921BPL	£103.47	19.21mm HSS 3-Flute Intermediate Slot Drill	19.21	104	38	20
D1922BPL	£103.47	19.22mm HSS 3-Flute Intermediate Slot Drill	19.22	104	38	20
D1923BPL	£103.47	19.23mm HSS 3-Flute Intermediate Slot Drill	19.23	104	38	20
D1924BPL	£103.47	19.24mm HSS 3-Flute Intermediate Slot Drill	19.24	104	38	20
D1925BPL	£103.47	19.25mm HSS 3-Flute Intermediate Slot Drill	19.25	104	38	20
D1926BPL	£103.47	19.26mm HSS 3-Flute Intermediate Slot Drill	19.26	104	38	20
D1927BPL	£103.47	19.27mm HSS 3-Flute Intermediate Slot Drill	19.27	104	38	20
D1928BPL	£103.47	19.28mm HSS 3-Flute Intermediate Slot Drill	19.28	104	38	20
D1929BPL	£103.47	19.29mm HSS 3-Flute Intermediate Slot Drill	19.29	104	38	20
D1930BPL	£103.47	19.3mm HSS 3-Flute Intermediate Slot Drill	19.30	104	38	20
D1931BPL	£103.47	19.31mm HSS 3-Flute Intermediate Slot Drill	19.31	104	38	20
D1932BPL	£103.47	19.32mm HSS 3-Flute Intermediate Slot Drill	19.32	104	38	20
D1933BPL	£103.47	19.33mm HSS 3-Flute Intermediate Slot Drill	19.33	104	38	20
D1934BPL	£103.47	19.34mm HSS 3-Flute Intermediate Slot Drill	19.34	104	38	20
D1935BPL	£103.47	19.35mm HSS 3-Flute Intermediate Slot Drill	19.35	104	38	20
D1936BPL	£103.47	19.36mm HSS 3-Flute Intermediate Slot Drill	19.36	104	38	20
D1937BPL	£103.47	19.37mm HSS 3-Flute Intermediate Slot Drill	19.37	104	38	20
D1938BPL	£103.47	19.38mm HSS 3-Flute Intermediate Slot Drill	19.38	104	38	20
D1939BPL	£103.47	19.39mm HSS 3-Flute Intermediate Slot Drill	19.39	104	38	20
D1940BPL	£103.47	19.4mm HSS 3-Flute Intermediate Slot Drill	19.40	104	38	20
D1941BPL	£103.47	19.41mm HSS 3-Flute Intermediate Slot Drill	19.41	104	38	20
D1942BPL	£103.47	19.42mm HSS 3-Flute Intermediate Slot Drill	19.42	104	38	20
D1943BPL	£103.47	19.43mm HSS 3-Flute Intermediate Slot Drill	19.43	104	38	20
D1944BPL	£103.47	19.44mm HSS 3-Flute Intermediate Slot Drill	19.44	104	38	20
D1945BPL	£103.47	19.45mm HSS 3-Flute Intermediate Slot Drill	19.45	104	38	20
D1946BPL	£103.47	19.46mm HSS 3-Flute Intermediate Slot Drill	19.46	104	38	20
D1947BPL	£103.47	19.47mm HSS 3-Flute Intermediate Slot Drill	19.47	104	38	20
D1948BPL	£103.47	19.48mm HSS 3-Flute Intermediate Slot Drill	19.48	104	38	20
D1949BPL	£103.47	19.49mm HSS 3-Flute Intermediate Slot Drill	19.49	104	38	20
D1950BPL	£103.47	19.5mm HSS 3-Flute Intermediate Slot Drill	19.50	104	38	20
D1951BPL	£103.47	19.51mm HSS 3-Flute Intermediate Slot Drill	19.51	104	38	20
D1952BPL	£103.47	19.52mm HSS 3-Flute Intermediate Slot Drill	19.52	104	38	20
D1953BPL	£103.47	19.53mm HSS 3-Flute Intermediate Slot Drill	19.53	104	38	20

(Prices do not include VAT)

SLOT DRILLS & END MILLS
3 Flute Intermediate Slot Drills
 Supplied by Leclerc

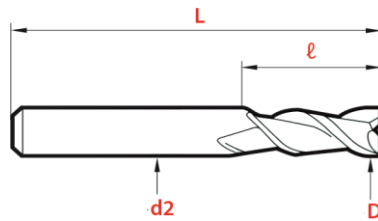

HSS M42 8% Cob

Tolerance			
D	L	ℓ	d2
-0.01	±1	+1	h6

Product Code	Price	Description	D	L	ℓ	d2
D1954BPL	£103.47	19.54mm HSS 3-Flute Intermediate Slot Drill	19.54	104	38	20
D1955BPL	£103.47	19.55mm HSS 3-Flute Intermediate Slot Drill	19.55	104	38	20
D1956BPL	£103.47	19.56mm HSS 3-Flute Intermediate Slot Drill	19.56	104	38	20
D1957BPL	£103.47	19.57mm HSS 3-Flute Intermediate Slot Drill	19.57	104	38	20
D1958BPL	£103.47	19.58mm HSS 3-Flute Intermediate Slot Drill	19.58	104	38	20
D1959BPL	£103.47	19.59mm HSS 3-Flute Intermediate Slot Drill	19.59	104	38	20
D1960BPL	£103.47	19.6mm HSS 3-Flute Intermediate Slot Drill	19.60	104	38	20
D1961BPL	£103.47	19.61mm HSS 3-Flute Intermediate Slot Drill	19.61	104	38	20
D1962BPL	£103.47	19.62mm HSS 3-Flute Intermediate Slot Drill	19.62	104	38	20
D1963BPL	£103.47	19.63mm HSS 3-Flute Intermediate Slot Drill	19.63	104	38	20
D1964BPL	£103.47	19.64mm HSS 3-Flute Intermediate Slot Drill	19.64	104	38	20
D1965BPL	£103.47	19.65mm HSS 3-Flute Intermediate Slot Drill	19.65	104	38	20
D1966BPL	£103.47	19.66mm HSS 3-Flute Intermediate Slot Drill	19.66	104	38	20
D1967BPL	£103.47	19.67mm HSS 3-Flute Intermediate Slot Drill	19.67	104	38	20
D1968BPL	£103.47	19.68mm HSS 3-Flute Intermediate Slot Drill	19.68	104	38	20
D1969BPL	£103.47	19.69mm HSS 3-Flute Intermediate Slot Drill	19.69	104	38	20
D1970BPL	£103.47	19.7mm HSS 3-Flute Intermediate Slot Drill	19.70	104	38	20
D1971BPL	£103.47	19.71mm HSS 3-Flute Intermediate Slot Drill	19.71	104	38	20
D1972BPL	£103.47	19.72mm HSS 3-Flute Intermediate Slot Drill	19.72	104	38	20
D1973BPL	£103.47	19.73mm HSS 3-Flute Intermediate Slot Drill	19.73	104	38	20
D1974BPL	£103.47	19.74mm HSS 3-Flute Intermediate Slot Drill	19.74	104	38	20
D1975BPL	£103.47	19.75mm HSS 3-Flute Intermediate Slot Drill	19.75	104	38	20
D1976BPL	£103.47	19.76mm HSS 3-Flute Intermediate Slot Drill	19.76	104	38	20
D1977BPL	£103.47	19.77mm HSS 3-Flute Intermediate Slot Drill	19.77	104	38	20
D1978BPL	£103.47	19.78mm HSS 3-Flute Intermediate Slot Drill	19.78	104	38	20
D1979BPL	£103.47	19.79mm HSS 3-Flute Intermediate Slot Drill	19.79	104	38	20
D1980BPL	£103.47	19.8mm HSS 3-Flute Intermediate Slot Drill	19.80	104	38	20
D1981BPL	£103.47	19.81mm HSS 3-Flute Intermediate Slot Drill	19.81	104	38	20
D1982BPL	£103.47	19.82mm HSS 3-Flute Intermediate Slot Drill	19.82	104	38	20
D1983BPL	£103.47	19.83mm HSS 3-Flute Intermediate Slot Drill	19.83	104	38	20
D1984BPL	£103.47	19.84mm HSS 3-Flute Intermediate Slot Drill	19.84	104	38	20
D1985BPL	£103.47	19.85mm HSS 3-Flute Intermediate Slot Drill	19.85	104	38	20
D1986BPL	£103.47	19.86mm HSS 3-Flute Intermediate Slot Drill	19.86	104	38	20
D1987BPL	£103.47	19.87mm HSS 3-Flute Intermediate Slot Drill	19.87	104	38	20
D1988BPL	£103.47	19.88mm HSS 3-Flute Intermediate Slot Drill	19.88	104	38	20
D1989BPL	£103.47	19.89mm HSS 3-Flute Intermediate Slot Drill	19.89	104	38	20
D1990BPL	£103.47	19.9mm HSS 3-Flute Intermediate Slot Drill	19.90	104	38	20
D1991BPL	£103.47	19.91mm HSS 3-Flute Intermediate Slot Drill	19.91	104	38	20
D1992BPL	£103.47	19.92mm HSS 3-Flute Intermediate Slot Drill	19.92	104	38	20
D1993BPL	£103.47	19.93mm HSS 3-Flute Intermediate Slot Drill	19.93	104	38	20
D1994BPL	£103.47	19.94mm HSS 3-Flute Intermediate Slot Drill	19.94	104	38	20
D1995BPL	£103.47	19.95mm HSS 3-Flute Intermediate Slot Drill	19.95	104	38	20
D1996BPL	£103.47	19.96mm HSS 3-Flute Intermediate Slot Drill	19.96	104	38	20
D1997BPL	£103.47	19.97mm HSS 3-Flute Intermediate Slot Drill	19.97	104	38	20

(Prices do not include VAT)

SLOT DRILLS & END MILLS
3 Flute Intermediate Slot Drills
 Supplied by Leclerc

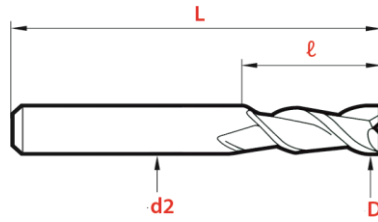

HSS M42 8% Cob

Tolerance			
D	L	ℓ	d2
-0.01	±1	+1	h6

Product Code	Price	Description	D	L	ℓ	d2
D1998BPL	£103.47	19.98mm HSS 3-Flute Intermediate Slot Drill	19.98	104	38	20
D1999BPL	£103.47	19.99mm HSS 3-Flute Intermediate Slot Drill	19.99	104	38	20
D2000BPL	£103.47	20mm HSS 3-Flute Intermediate Slot Drill	20.00	104	38	20

(Prices do not include VAT)