

Serrated Soft Top Jaws

Page 5 - 41

Serrated Hard Top Jaws

Page 43 - 103

Slot/Tenon Soft Top Jaws

Page 105 - 111

Slot/Tenon Hard Top Jaws

Page 113 - 127

Scroll Jaws Soft & Hard

Page 129 - 133

Base Jaws & Monoblok Jaws

Page 135 - 141

InoZet®
InoTop®
Inogrip®
InoFlex®

Page 143 - 145

Specialist Jaws & Services

Page 147 - 152

T-Nuts & Accessories

Page 155 - 167

Technical Information

Page 168 - 172

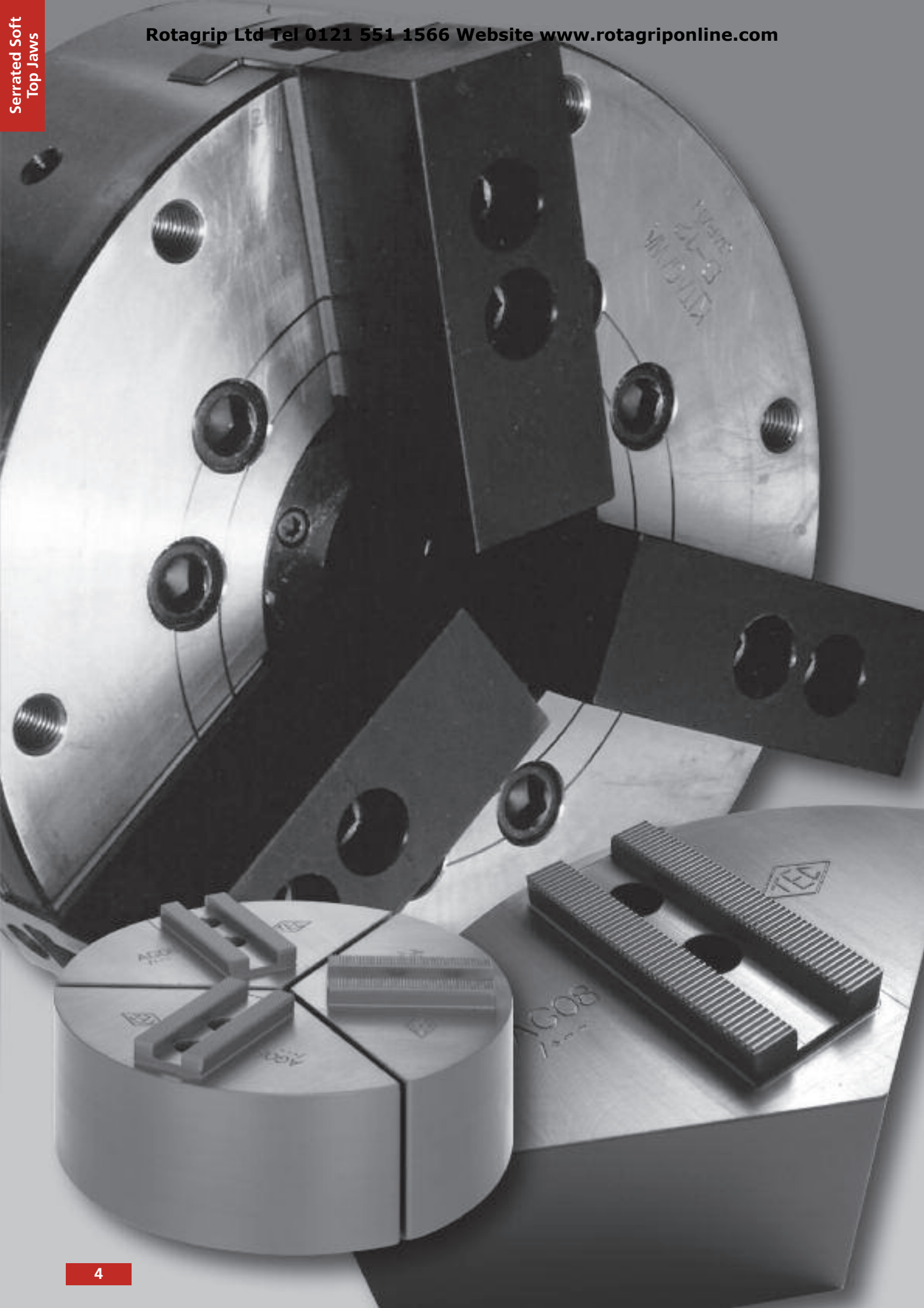

Serrated Soft
Top Jaws

Serrated Soft Top Jaws

Page



Blank Jaws

- With or without bolt holes
- 60° or 90° serrations
- Steel or Aluminium

7 - 9

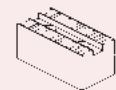

Standard Jaws

- For power chucks
- 60° or 90° serrations
- Steel or Aluminium

10 - 41



Long Pointed Jaws

- For power chucks
- 60° or 90° serrations
- Steel or Aluminium

10 - 41



Front Relieved Pointed Jaws

- For power chucks
- 2 or 3 bolt holes
- 60° or 90° serrations
- Steel

10 - 41

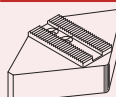

Diamond Jaws

- For power chucks
- 60° or 90° serrations
- Steel or Aluminium

10 - 35



Segment Jaws

- For power chucks
- 60° or 90° serrations
- Steel or Aluminium

10 - 35

	Blank Jaws Steel or Aluminium	Standard & large Jaws	Long Pointed Jaws	Front Relieved Pointed Jaws	Diamond or Segment Jaws Steel or Aluminium
	Page	Page	Page	Page	Page
AUTOBLOK	7-9	28-29, 32-33, 40-41	28-29, 32-33		28-29, 32-35
AUTOSTRONG	7-9	10-11, 14-15, 18-19 22-23	10-11, 14-15, 18-19		10-11, 14-15, 18-19 22-23
BERG	7-9	28-29, 32-33, 36	28-29, 32-33		28-29, 32-35
FORKARDT	7-9	28-29, 32-33, 40-41	28-29, 32-33		28-29, 32-35
GAMET	7-9	26-27, 28-29, 32-33	28-29, 32-33	26-27, 38	28-29, 32-35
HARDINGE	7-9	10-11, 14-15, 18-19	10-11, 14-15, 18-19		10-11, 14-15, 18-19
HERBERT COVENTRY		39			
HOWA	7-9	10-11, 14-15, 18-19 26	10-11, 14-15, 18-19		10-11, 14-15, 18-19
KITAGAWA	7-9	10-11, 14-15, 18-19 22-23	10-11, 14-15, 18-19		10-11, 14-15, 18-19 22-23
LEADER	7-9	10-11, 14-15, 18-19	10-11, 14-15, 18-19		10-11, 14-15, 18-19
MMK MATSUMOTO	7-9	10-11, 14-15, 18-19 22-23	10-11, 14-15, 18-19	10-11, 14-15	10-11, 14-15, 18-19 22-23
NIKKO				26-27	
PRATT BURNERD	7-9	12-13, 16-17, 20-21, 24-25, 30-31, 34-35 37, 39	12-13, 16-17, 20-21 30-31, 34-35		12-13, 16-17, 20-21 24-25, 30-31, 34-35
RÖHM	7-9	12-13, 16-17, 20-21 26-27, 30-31, 34-35 37, 40-41	12-13, 16-17, 20-21 26-27, 30-31, 34-35		12-13, 16-17, 20-21 30-31, 34-35
SAMCHULLY	7-9	12-13, 16-17, 20-21 24-25	12-13, 16-17, 20-21		12-13, 16-17, 20-21 24-25
SCHUNK	7-9	12-13, 16-17, 20-21, 24-25 30-31, 34-35, 37-38 40-41	12-13, 16-17, 20, 21 30-31, 34-35		12-13, 16-17, 20-21, 24-25 30-31, 34-35
SEOAM	7-9	12-13, 16-17, 20-21 24-25	12-13, 16-17, 20-21		12-13, 16-17, 20-21, 24-25
SMW	7-9	30-31, 34-35, 38, 40-41	30-31, 34-35		30-31, 34-35
SMW-AUTOBLOK	7-9	12-13, 16-17, 20-21 28-29, 32-33, 36, 38 40-41	12-13, 16-17, 20-21 28-29, 32-33		28-29, 32-33
TONFOU	7-9	12-13, 16-17, 20-21 24-25	12-13, 16-17, 20-21		12-13, 16-17, 20-21 24-25

Serrated Top Jaw and Chuck Data Sheet

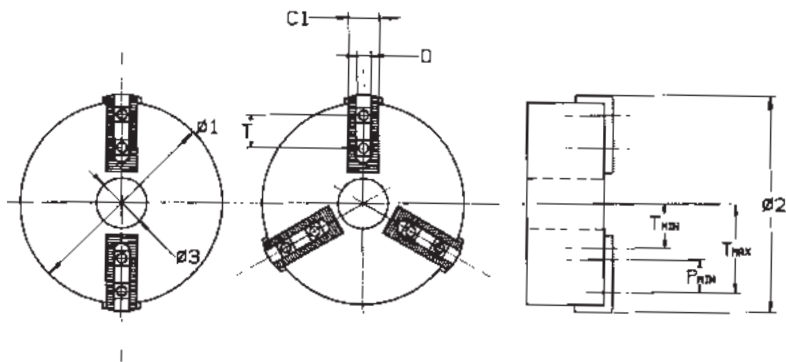

		2 JAW CHUCK DATA	3 JAW CHUCK DATA	REMARKS
Chuck Manufacturer / Model No.				
Chuck ϕ / Type	$\phi 1$			
Maximum Swing ϕ	$\phi 2$			
Chuck Bore	$\phi 3$			
Base Jaw Width	C1			
T-Nut Minimum Position	Tmin			
T-Nut Maximum Position	Tmax			
T-Nuts Minimum Hole Pitch	Pmin			
Are Base Jaw Serrations Above Chuck Face	Yes			
	No			
Are T-Nuts Single or Double	Single			
	Double			
Slot Width	D			
Hole Centre Spacing	K			
Hole Centre To Back of Jaw	J			
Counterbore / Hole ϕ	G/F			
Depth Under Bolt Head	X			
Serration Pitch & Angle	L			
Length Of Jaw	A			
Height Of Jaw	B			
Width Of Jaw	C			

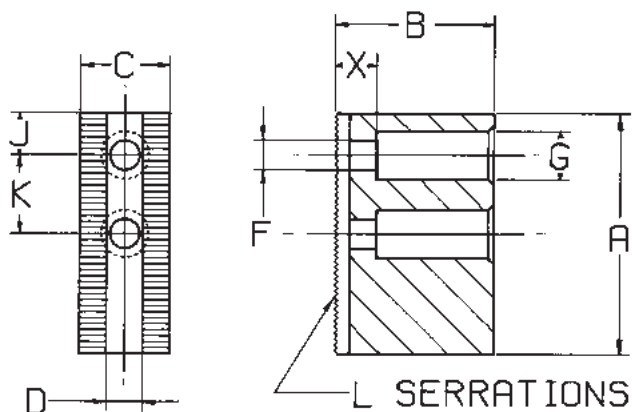

Serrated Soft Top Jaws 60° SERRATIONS - WITH OR WITHOUT BOLT HOLES

Material:

- Carbon Case Hardening Steel, 080M15 (En32)
- Black Finish

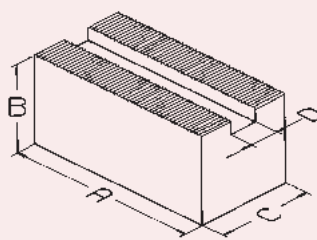

WITHOUT BOLT HOLES

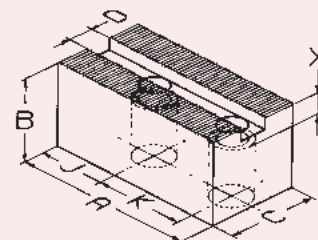

DRILLED

Serrated Steel Blanks 1.5mm x 60°

PART No.	SERRATIONS	A	B	C	D	WEIGHT Kg/Set	DRILLED TO SUIT BOLT	J, K & X
HJ 02	1.5mm x 60°	72	35	30	12	1.9	M10	Please specify or state chuck to suit
HJ 03		72	60	30		3.0		
HJ 04		72	80	30		4.0		
HJ 05		60	50	50		3.4		
HJ 06		82	30	30		1.5		
HK 01		1.5mm x 60°	90	35		35		
HK 02	90		60	35	3.7			
HK 03	95		80	35	4.9			
HK 04	95		100	35	7.2			
HK 06	102		40	35	3.3			
HK 07	75		50	65	5.6			
HM 02	1.5mm x 60°		84	40	40	16	3.1	M12
HM 03		110	40	40	4.1			
HM 04		90	60	40	5.0			
HM 05		110	60	40	6.2			
HM 06		110	80	40	7.8			
HM 07		110	100	40	10.3			
HM 08		110	125	40	12.9			
HM 09		90	50	80	8.2			
HM 10		125	40	40	4.8			
HO 02		1.5mm x 60°	130	50	50		18	
HO 03	130		80	50	11.7			
HO 05	130		100	50	15.7			
HO 06	130		125	50	19.7			
HO 07	145		50	50	8.2			
HS 01	1.5mm x 60°	130	50	50	21	7.6	M16	Please specify or state chuck to suit
HS 02		130	80	50		11.5		
HS 03		130	100	50		15.5		
HS 04		130	125	50		19.5		
HS 05		145	50	50		8.2		

Serrated Soft Top Jaws

90° SERRATIONS - WITH OR WITHOUT BOLT HOLES

Material:

- Carbon Case Hardening Steel, 080M15 (En32)
- Black Finish

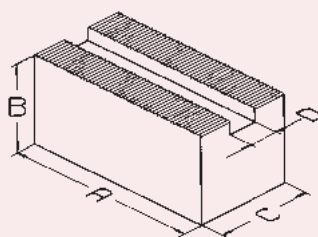

WITHOUT BOLT HOLES

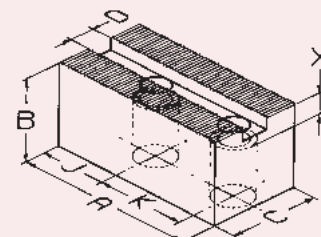

DRILLED

Serrated Steel Blanks 1/16" x 90°

PART No.	SERRATIONS	A	B	C	D	WEIGHT Kg/Set	DRILLED TO SUIT BOLT	J, K & X
FJ 02	1/16" x 90°	80	50	40	17	3.7	M12	Please specify or state chuck to suit
FJ 03		98	50	40		4.7		
FJ 04		70	60	40		3.8		
FJ 05		90	60	40		4.9		
FJ 06		110	60	40		6.2		
FJ 07		90	80	40		6.4		
FJ 08		90	40	40		3.2		
FJ 09		90	50	80		8.7		
FJ 10		90	100	40		8.7		
FL 01		1/16" x 90°	90	50		50		
FL 02	120		50	50	6.7			
FL 03	140		50	50	8.5			
FL 04	170		65	50	12.9			
FL 06	120		80	50	10.9			
FL 07	120		100	50	14.6			
FL 09	95		70	70	11.0			
FL 10	120		76	101	21.8			
FL 11	120		125	50	17.6			

Serrated Steel Blanks 3/32" x 90°

PART No.	SERRATIONS	A	B	C	D	WEIGHT Kg/Set	DRILLED TO SUIT BOLT	J, K & X
FN 01	3/32" x 90°	140	60	60	25.5	12.3	M20	Please specify or state chuck to suit
FN 04		155	90	60		19.5		
FN 05		150	125	60		27.4		
FN 06		150	80	80		22.6		

Serrated Soft Top Jaws 60° & 90° SERRATIONS - WITH OR WITHOUT BOLT HOLES

Material:

- Aluminium: HE30TF
- Natural Finish

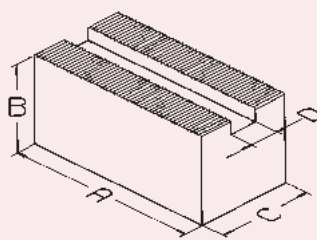

WITHOUT BOLT HOLES

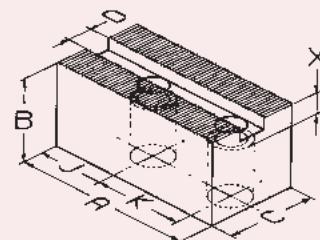

DRILLED

Serrated Aluminium Blanks 1.5mm x 60°

PART No.	SERRATIONS	A	B	C	D	WEIGHT Kg/Set	DRILLED TO SUIT BOLT	J, K & X
HP 01	1.5mm x 60°	72	38	32	12	0.7	M10	Please specify or state chuck to suit
HP 02		72	76	32		1.4		
HP 05	1.5mm x 60°	95	44	32	14	1.1	M12	
HP 06		95	76	32		1.9		
HP 07		95	102	32		2.5		
HP 11	1.5mm x 60°	110	51	38	16	1.7	M12	
HP 12		110	76	38		2.5		
HP 13		110	102	38		3.3		
HP 17	1.5mm x 60°	130	51	51	18	2.7	M14	
HP 18		130	76	51		4.1		
HP 19		130	102	51		5.4		
HP 25	1.5mm x 60°	130	51	51	21	2.5	M16	
HP 26		130	76	51		4.0		
HP 27		130	102	51		5.2		

Serrated Aluminium Blanks 1/16" x 90°

PART No.	SERRATIONS	A	B	C	D	WEIGHT Kg/Set	DRILLED TO SUIT BOLT	J, K & X
HR 01	1/16" X 90	70	51	38	17	1.1	M12	Please specify or state chuck to suit
HR 02		90	76	38		2.1		
HR 03		90	102	38		2.8		
HR 06	1/16" X 90	120	51	51	21	2.5	M16	
HR 07		120	76	51		3.8		
HR 08		120	102	51		5.0		

Serrated Soft Top Jaws

60° SERRATIONS

Material:

- Steel: 080M15 (En32) • Black Finish
- Aluminium: HE30TF • Natural Finish

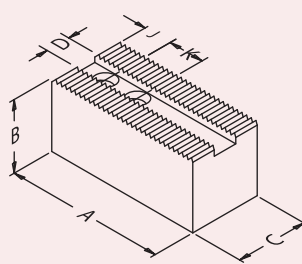

TYPE: **AS** - STEEL **AA** - ALUMINIUM

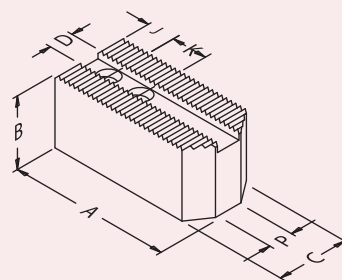

TYPE: **BS** - STEEL

Chuck Ø 110mm - 210mm

PART No.	JAW TYPE	A	B	C	D	K&J BOLT	P	SERRATIONS	WEIGHT Kg/Set
BO 04	BS	48	25	20	8	15+8 M6	4	1.5mm x 60°	0.5
BR 04	BS	45	25	25	10	14+13 M8	4	1.5mm x 60°	0.3
BB 04	BS	45	40	25	10	14+13 M8	4		0.5
BR 05	BS	55	25	25	10	14+13 M8	4		0.6
BB 05	BS	55	40	25	10	14+13 M8	4		1.0
DK 05	AS	55	50	25	10	14+13 M8			1.1
BH 05	AS	55	60	25	10	14+13 M8			1.4
HN 12	DA	50	50	100	10	14+13 M8			3.5
BO 05	BS	57	35	25	10	18+10 M8	4	1.5mm x 60°	0.9
DJ 05	AS	57	50	25	10	18+10 M8			1.3
CK 05	BS	62	25	25	10	19+8 M8	4	1.5mm x 60°	0.9
DU 05	AS	48	25	25	11	16+9.5 M8		1.5mm x 60°	0.7
CK 06	CS	80	35	30	11	25+14 M8	8	1.5mm x 60°	1.4
BX 12	BS	60	35	30	12	16+15 M10	8	1.5mm x 60°	1.2
BX 13	AS	52	25	25	12	14+8 M8		1.5mm x 60°	0.8
BX 17	AS	70	30	30	12	17+11 M10		1.5mm x 60°	1.1
BO 06	AS	72	35	30	12	20+15 M10		1.5mm x 60°	1.3
AA 06	AA	72	38	32	12	20+15 M10			0.7
BA 06	BS	72	30	30	12	20+15 M10	5		1.0
BQ 06	AS	72	30	30	12	20+15 M10			1.1
BB 06	AS	72	40	30	12	20+15 M10			1.5
BC 06	AS	72	50	30	12	20+15 M10			1.8
DJ 06	AS	72	60	30	12	20+15 M10			2.2
AB 06	AA	72	76	32	12	20+15 M10			1.4
PT 06	BS	82	30	30	12	20+15 M10	5		1.3
CN 16	DS	60	60	120	12	20+15 M10			9.0
HN 16	DA	64	64	120	12	20+15 M10			3.2
HN 17	DA	64	100	120	12	20+15 M10			5.0
SG 06	ES	76	76	Ø169	12	20+20 M10			13.0
AG 06	EA	76	76	Ø169	12	20+20 M10			6.0
BD 06	FS	72	60	30	12	20+15 M10	5		1.8

IMPORTANT: Allow for weight of Large Diamond/Segment Jaws at high R.P.M.'s as the grip loss due to the effect of centrifugal forces will be greater.

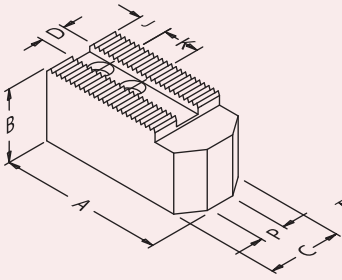

TYPE: **CS** - STEEL

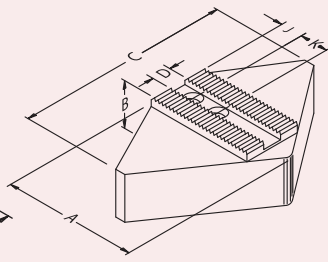

TYPE: **DS** - STEEL **DA** - ALUMINIUM

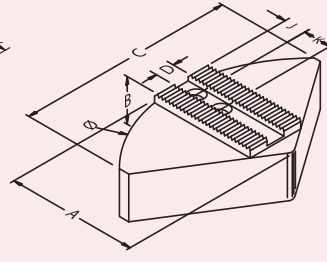

TYPE: **ES** - STEEL **EA** - ALUMINIUM

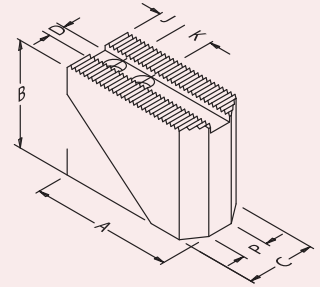

TYPE: **FS** STEEL

AUTOSTRONG	HARDINGE (SURE GRIP)	HOWA	KITAGAWA	LEADER	MATSUMOTO (MMK)
N204;N205;NT205	4" SURE-GRIP 5" SURE-GRIP	HO1MA4 HO24M5	B04; HOB-4 B204; N-04; BT204; AS04 B205; BT205; AS110 HJA-4; HL04; NT04		H-4-21; Z-4-21 Z-5-34 PC-5-34
			HOB-5; B-05		
		HO1MA5	HJA-5; N-05; NT05		HXA5-6-34 HHXA5-6 ZA5-6-40
		HO27M4 HO27M5			
					HA5-6; HH-6; HX-6; HJ-6; H-6; STC-6 ZA-5-6
N206;V206;NT206 NB206	6" SURE-GRIP	HO7MA6; HO15MA6 HO22M6; HO24M6 HO27M6; HO37M6 HO47M6; HO23M8 H3KT6	HJA5-6; HOS-6; N-06 HOB-6; AS-165; B206 B-160; HO-06; B-06; NL06 BB-06; BT206; HOH-160 HOH-206; HOH-06; B-07 N-160; B-106; BL206 BB206; BS306; BLT206; NLT06; DL06; ML06; HW08; BT-06	LC165 KHF 165	PC-6-46

Serrated Soft Top Jaws

60° SERRATIONS

Material:

- Steel: 080M15 (En32) • Black Finish
- Aluminium: HE30TF • Natural Finish

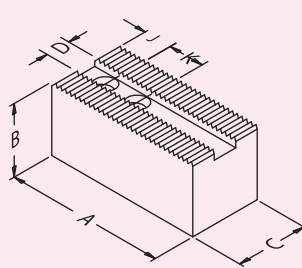

TYPE: **AS** - STEEL **AA** - ALUMINIUM

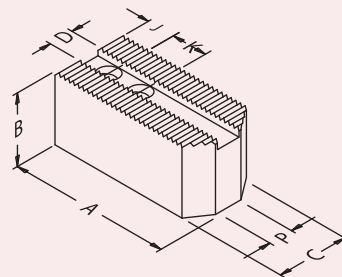

TYPE: **BS** - STEEL

Chuck Ø 110mm - 210mm

PART No.	JAW TYPE	A	B	C	D	K&J BOLT	P	SERRATIONS	WEIGHT Kg/Set
BO 04	BS	48	25	20	8	15+8 M6	4	1.5mm x 60°	0.5
BR 04	BS	45	25	25	10	14+13 M8	4	1.5mm x 60°	0.3
BB 04	BS	45	40	25	10	14+13 M8	4		0.5
BR 05	BS	55	25	25	10	14+13 M8	4		0.6
BB 05	BS	55	40	25	10	14+13 M8	4		1.0
DK 05	AS	55	50	25	10	14+13 M8			1.1
BH 05	AS	55	60	25	10	14+13 M8			1.4
HN 12	DA	50	50	100	10	14+13 M8			3.5
BO 05	BS	57	35	25	10	18+10 M8	4	1.5mm x 60°	0.9
DJ 05	AS	57	50	25	10	18+10 M8			1.3
CK 05	BS	62	25	25	10	19+8 M8	4	1.5mm x 60°	0.9
DU 05	AS	48	25	25	11	16+9.5 M8		1.5mm x 60°	0.7
CK 06	CS	80	35	30	11	25+14 M8	8	1.5mm x 60°	1.4
BX 12	BS	60	35	30	12	16+15 M10	8	1.5mm x 60°	1.2
BX 13	AS	52	25	25	12	14+8 M8		1.5mm x 60°	0.8
BX 17	AS	70	30	30	12	17+11 M10		1.5mm x 60°	1.1
BO 06	AS	72	35	30	12	20+15 M10		1.5mm x 60°	1.3
AA 06	AA	72	38	32	12	20+15 M10			0.7
BA 06	BS	72	30	30	12	20+15 M10	5		1.0
BQ 06	AS	72	30	30	12	20+15 M10			1.1
BB 06	AS	72	40	30	12	20+15 M10			1.5
BC 06	AS	72	50	30	12	20+15 M10			1.8
DJ 06	AS	72	60	30	12	20+15 M10			2.2
AB 06	AA	72	76	32	12	20+15 M10			1.4
PT 06	BS	82	30	30	12	20+15 M10	5		1.3
CN 16	DS	60	60	120	12	20+15 M10			9.0
HN 16	DA	64	64	120	12	20+15 M10			3.2
HN 17	DA	64	100	120	12	20+15 M10			5.0
SG 06	ES	76	76	Ø169	12	20+20 M10			13.0
AG 06	EA	76	76	Ø169	12	20+20 M10			6.0
BD 06	FS	72	60	30	12	20+15 M10	5		1.8

IMPORTANT: Allow for weight of Large Diamond/Segment Jaws at high R.P.M.'s as the grip loss due to the effect of centrifugal forces will be greater.

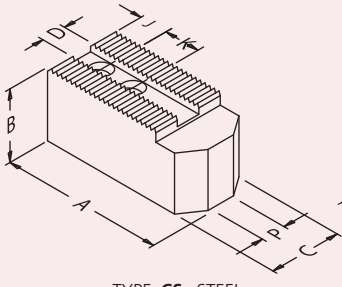

TYPE: **CS** - STEEL

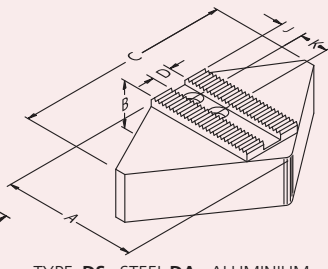

TYPE: **DS** - STEEL **DA** - ALUMINIUM

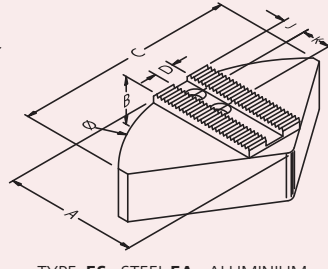

TYPE: **ES** - STEEL **EA** - ALUMINIUM

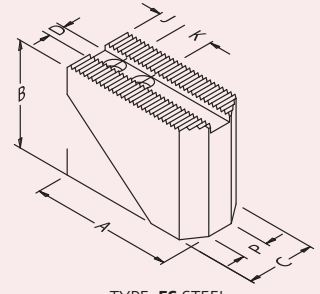

TYPE: **FS** STEEL

PRATT BURNERD	RÖHM	SAMCHULLY (POWER GRIP)	SEOAM (ACE)	SCHUNK	SMW-AUTOBLOK	TONFOU
		HCH-04				
	KFD-HE 130; KFN 105	HC-04 HS-04 HS-05	CAS-4; CAH-5			TF3B-04; TF38-05
		HCH-05	CAS-5			
		HC-05				
					AN-M 125; AL-M 125; PB-M 130; PB1-M 130; BH-M 130; BB-M 140	
125 INTERNATIONAL 150 KING BORE						
165 INTERNATIONAL 170 KING BORE						
165 CONSTANT GRIP 170 INTERNATIONAL 165 HIGH SPEED Q C	KFD-HE 170	HCH-06; HC06 HS-06 HH206 MH206	CAH-6; CAS-6 CGH-6	ROTA NCD 165-185; ROTA NCK 165 ROTA NC/NCF 165; HSL 165; ROTA NCK plus 165; ROTA NC plus 185; ROTA NCF 185	AL-M 165; AN-M 165; BB-M 175; BH-M 165; BH-M FC 165; HB-M 165 HFKN-M 165; PB-M 165; PBI-M 165; AP-M 170; NT-M 170; RC-M165	TF3B-06; TF3X-6 VA-206; VT-206

Serrated Soft Top Jaws

60° SERRATIONS

Material:

- Steel: 080M15 (En32) • Black Finish
- Aluminium: HE30TF • Natural Finish

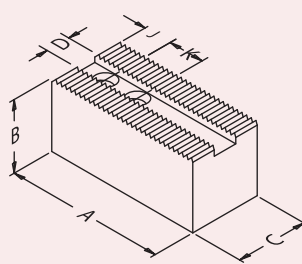

TYPE: AS- STEEL AA - ALUMINIUM

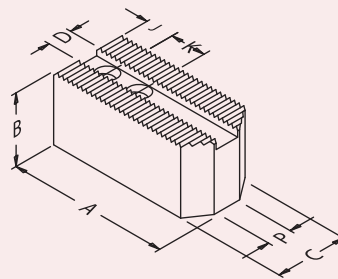

TYPE: BS - STEEL

Chuck Ø 210mm - 265mm

PART No.	JAW TYPE	A	B	C	D	K&J BOLT	P	SERRATIONS	WEIGHT Kg/Set
BQ 08	AS	90	35	35	14	25+20 M12		1.5mm x 60°	2.2
BO 08	AS	95	40	35	14	25+25 M12			2.7
AA 08	AA	95	44	32	14	25+25 M12			1.1
BA 08	BS	95	35	35	14	25+25 M12	5		2.4
BB 08	AS	95	50	35	14	25+25 M12			3.4
BC 08	AS	95	60	35	14	25+25 M12			4.0
DJ 08	AS	95	80	35	14	25+25 M12			5.4
AB 08	AA	95	76	32	14	25+25 M12			1.9
AC 08	AA	95	102	32	14	25+25 M12			2.5
CK 08	CS	85	40	35	14	25+20 M12	15		2.2
CK 09	CS	95	40	35	14	25+20 M12	15		2.7
PT 08	BS	102	40	35	14	25+20 M12	5		2.9
CN 20	DS	89	64	150	14	25+15 M12			14.0
HN 20	DA	76	64	150	14	25+15 M12			5.0
HN 21	DA	76	100	150	14	25+15 M12			7.8
SG 08	ES	99	76	Ø210	14	25+25 M12			20.0
AG 08	EA	99	76	Ø210	14	25+25 M12		9.8	
DU 08	AS	85	40	40	16	25+20 M12		1.5mm x 60°	2.8
DU 09	AS	85	60	40	16	25+20 M12			4.0
BO 10	AS	110	40	40	16	30+30 M12		1.5mm x 60°	3.4
AA 10	AA	110	51	38	16	30+30 M12			1.7
BA 10	BS	110	40	40	16	30+30 M12	5		3.1
BR 10	AS	110	60	40	16	30+30 M12			4.5
DJ 10	AS	110	80	40	16	30+30 M12			6.5
BD 10	AS	110	100	40	16	30+30 M12			8.5
AB10	AA	110	76	38	16	30+30 M12			2.5
AC 10	AA	110	102	38	16	30+30 M12			3.3
PT 10	BS	125	40	40	16	30+30 M12	5		4.5
DK 10	AS	90	60	40	16	30+21 M12			4.2
DK 11	CS	110	60	40	16	30+21 M12	10		5.2
CN 25	DS	102	64	170	16	30+20 M12			20.0
HN 25	DA	102	64	170	16	30+20 M12			7.0
HN 26	DA	102	100	170	16	30+20 M12			10.9
SG 10	ES	122	76	Ø254	16	30+27 M12			29.0
AG 10	EA	122	76	Ø254	16	30+27 M12			13.0

IMPORTANT: Allow for weight of Large Diamond/Segment Jaws at high R.P.M.'s as the grip loss due to the effect of centrifugal forces will be greater.

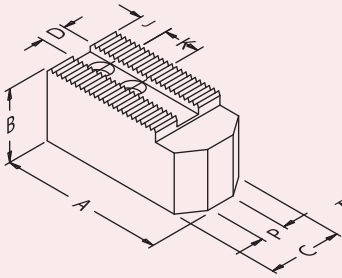

TYPE: **CS** - STEEL

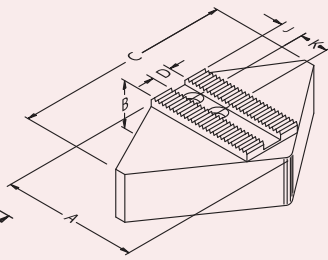

TYPE: **DS** - STEEL **DA** - ALUMINIUM

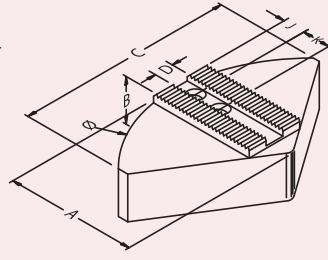

TYPE: **ES** - STEEL **EA** - ALUMINIUM

AUTOSTRONG	HARDINGE (SURE GRIP)	HOWA	KITAGAWA	LEADER	MATSUMOTO (MMK)
N208;V208;HT208; NB208	8" SURE-GRIP	HO7MA8; HO15M8	B208; B-08; HOB-8 N-200; HOH-200; N-08 HOH-8; AS-210; NL08; HOS-8; BT208; HJA6-8 HOH-208; HO-8; HOH108; B-108; BB08; BL208 BB208; HG715-210 BS308; BLT208; ML08; NLT08; DL08; UVE160K BT-08	LC210 KHF 210	HA6-8; HX-8; H-8; HH-8; HJ-8; HHJ-8; STC-8; ZA6-8-52; ZA6-8-66 PC-8-52
		HO27M8; HO47M8; HO24M8; HO22M8; HO37M8; HO7MA10; HO23M10; HO15M10			
N210;V210;NT210 NB210	10" SURE-GRIP	H3KT10	B250; B-10; HOH-250 HOH-10K; B210; HOB-10 AS-250; N-250; N-10 HJA6-10; HJ8-10; HOS-10 HO-10; NL-10; BT210 B-110; UVE-K200; HOH110 UVE-200K; HOH-210; BL210; HG730-254; B210X BB210; BS310; BLT210; BT210; NLT10; UVE250K; BT-10	LC250 KHF 250	HA6-10; HA8-10; ZA6-10-75; H-10; HX-10; HHL-10; HH-10; HHJ-10; HJ-10; HA8-11; STC-10 PC-10-78

Serrated Soft Top Jaws

60° SERRATIONS

Material:

- Steel: 080M15 (En32) • Black Finish
- Aluminium: HE30TF • Natural Finish

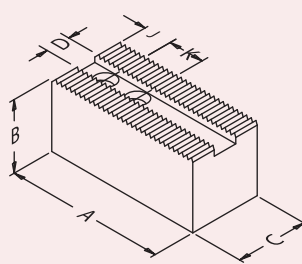

TYPE: AS- STEEL AA - ALUMINIUM

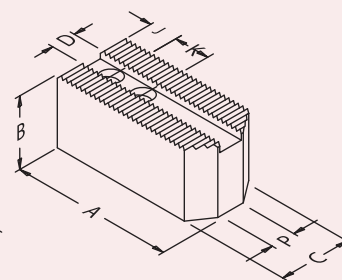

TYPE: BS - STEEL

Chuck Ø 210mm - 265mm

PART No.	JAW TYPE	A	B	C	D	K&J BOLT	P	SERRATIONS	WEIGHT Kg/Set
BQ 08	AS	90	35	35	14	25+20 M12		1.5mm x 60°	2.2
BO 08	AS	95	40	35	14	25+25 M12			2.7
AA 08	AA	95	44	32	14	25+25 M12			1.1
BA 08	BS	95	35	35	14	25+25 M12	5		2.4
BB 08	AS	95	50	35	14	25+25 M12			3.4
BC 08	AS	95	60	35	14	25+25 M12			4.0
DJ 08	AS	95	80	35	14	25+25 M12			5.4
AB 08	AA	95	76	32	14	25+25 M12			1.9
AC 08	AA	95	102	32	14	25+25 M12			2.5
CK 08	CS	85	40	35	14	25+20 M12	15		2.2
CK 09	CS	95	40	35	14	25+20 M12	15		2.7
PT 08	BS	102	40	35	14	25+20 M12	5		2.9
CN 20	DS	89	64	150	14	25+15 M12			14.0
HN 20	DA	76	64	150	14	25+15 M12			5.0
HN 21	DA	76	100	150	14	25+15 M12			7.8
SG 08	ES	99	76	Ø210	14	25+25 M12			20.0
AG 08	EA	99	76	Ø210	14	25+25 M12		9.8	
DU 08	AS	85	40	40	16	25+20 M12		1.5mm x 60°	2.8
DU 09	AS	85	60	40	16	25+20 M12			4.0
BO 10	AS	110	40	40	16	30+30 M12		1.5mm x 60°	3.4
AA 10	AA	110	51	38	16	30+30 M12			1.7
BA 10	BS	110	40	40	16	30+30 M12	5		3.1
BR 10	AS	110	60	40	16	30+30 M12			4.5
DJ 10	AS	110	80	40	16	30+30 M12			6.5
BD 10	AS	110	100	40	16	30+30 M12			8.5
AB10	AA	110	76	38	16	30+30 M12			2.5
AC 10	AA	110	102	38	16	30+30 M12			3.3
PT 10	BS	125	40	40	16	30+30 M12	5		4.5
DK 10	AS	90	60	40	16	30+21 M12			4.2
DK 11	CS	110	60	40	16	30+21 M12	10		5.2
CN 25	DS	102	64	170	16	30+20 M12			20.0
HN 25	DA	102	64	170	16	30+20 M12			7.0
HN 26	DA	102	100	170	16	30+20 M12			10.9
SG 10	ES	122	76	Ø254	16	30+27 M12			29.0
AG 10	EA	122	76	Ø254	16	30+27 M12			13.0

IMPORTANT: Allow for weight of Large Diamond/Segment Jaws at high R.P.M.'s as the grip loss due to the effect of centrifugal forces will be greater.

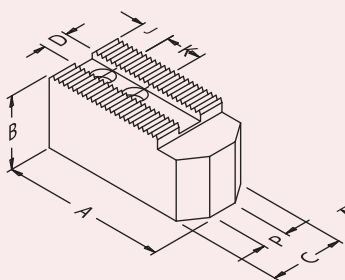

TYPE: **CS** - STEEL

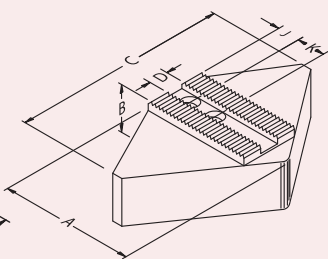

TYPE: **DS** - STEEL **DA** - ALUMINIUM

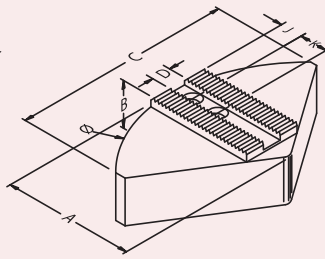

TYPE: **ES** - STEEL **EA** - ALUMINIUM

PRATT BURNERD	RÖHM	SAMCHULLY (POWER GRIP)	SEOAM (ACE)	SCHUNK	SMW-AUTOBLOK	TONFOU
210 INTERNATIONAL 210 HIGH SPEED Q C	KFD-HE 210	HCH-08; HC-08; HS-08 HH208 MH-208	CAH-8; CAS-8 CGH-8	ROTA NCD 210; ROTA NCK 210; ROTA NC/NCF 210; HSL 210; ROTA NCK plus 210; ROTA NC plus 215; ROTA NCF plus 215	AL-M 210; AN-M 210; BB-M 210; BH-M 210; BH-M FC 210; HB-M 210 HFKN-M 210; PB-M 210; PBI-M 210; AP-M 215; APL-M 215; NT-M 215 RC-M210	TF3B-08; TF3X-8 V-208; VA-208 VT-208
254 CONSTANT GRIP 254 HIGH SPEED Q C 265 INTERNATIONAL	KFD-HE 254	HCH-10; HC-10; HS-10; HH210 MH-210	CAH-10; CAS-10; CGH-10;	ROTA NCD 250; ROTA NCK 250; ROTA NC/NCF 250; HSL 250; ROTA NCK plus 250; ROTA NC plus 260; ROTA NCF plus 260	AL-M 250; AN-M 250; BB-M 250; BH-M 250; BH-M FC 250; HB-M 250; HFKN-M 260; PB-M 250; PBI-M 250; AP-M 260; APL-M 260; NT-M 260 RC-M250	TF3B-10; TF3X-10 V-210; VA-210; VT-210

Serrated Soft Top Jaws

60° SERRATIONS

Material:

- Steel: 080M15 (En32) • Black Finish
- Aluminium: HE30TF • Natural Finish

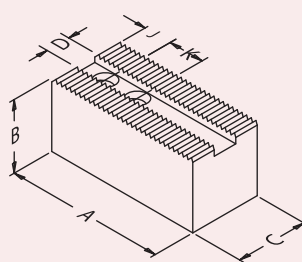

TYPE: **AS**- STEEL **AA** - ALUMINIUM

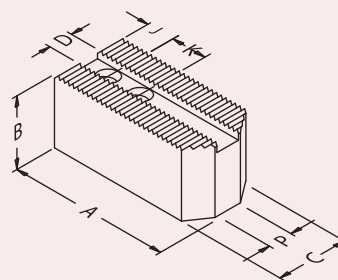

TYPE: **BS** - STEEL

Chuck Ø 265mm - 450mm

PART No.	JAW TYPE	A	B	C	D	K&J BOLT	P	SERRATIONS	WEIGHT Kg/Set
DU 10	AS	105	40	40	18	30+24 M14		1.5mm x 60°	4.4
DU 11	AS	105	60	40	18	30+24 M14			6.6
BO 12	AS	130	50	50	18	30+40 M14	10	1.5mm x 60°	6.8
AA 12	AA	130	51	51	18	30+40 M14			2.7
DJ 12	AS	130	80	50	18	30+40 M14			10.9
AB 12	AA	130	76	51	18	30+40 M14			4.1
DJ 14	AS	130	100	50	18	30+40 M14			13.6
AC 12	AA	130	102	51	18	30+40 M14			5.4
PT 12	BS	145	50	50	18	30+40 M14			7.3
CN 32	DS	132	76	240	18	30+30 M14			28.0
HN 32	DA	132	76	240	18	30+30 M14			10.0
HN 30	DA	132	100	240	18	30+30 M14			13.2
SG 12	ES	146	76	Ø304	18	30+34 M14	41.0		
AG 12	EA	146	76	Ø304	18	30+34 M14	15.0		
BR 13	AS	130	50	50	21	30+40 M16	10	1.5mm x 60°	6.5
AA 13	AA	130	51	51	21	30+40M16			2.5
DJ 13	AS	130	80	50	21	30+40M16			10.4
BD 13	AS	130	100	50	21	30+40 M16			13.0
AB 13	AA	130	76	51	21	30+40 M16			4.0
AC 13	AA	130	102	51	21	30+40 M16			5.2
PT 13	BS	145	50	50	21	30+40 M16			7.3
CN 33	DS	132	76	240	21	30+30 M16			28.0
HN 33	DA	132	76	240	21	30+30 M16			10.0
HN 34	DA	132	100	240	21	30+30 M16			13.2
SG 13	ES	147	76	Ø304	21	30+34 M16	41.0		
AG 13	EA	147	76	Ø304	21	30+34 M16	15.0		
DU 12	AS	111	60	50	21	35+25 M16		1.5mm x 60°	7.1

IMPORTANT: Allow for weight of Large Diamond/Segment Jaws at high R.P.M.'s as the grip loss due to the effect of centrifugal forces will be greater.

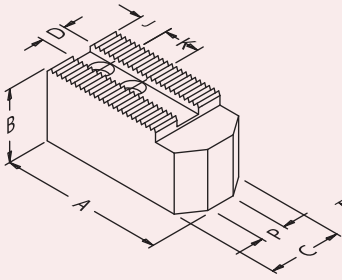

TYPE: **CS** - STEEL

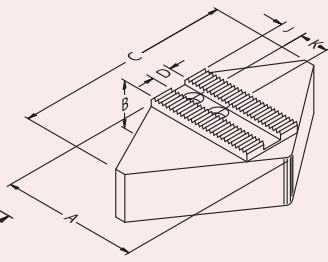

TYPE: **DS** - STEEL **DA** - ALUMINIUM

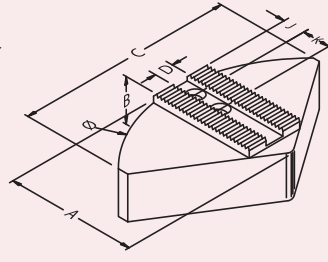

TYPE: **ES** - STEEL **EA** - ALUMINIUM

AUTOSTRONG	HARDINGE (SURE GRIP)	HOWA	KITAGAWA	LEADER	MATSUMOTO (MMK)
		H022M10; H037M10; H024M10; H027M10 H047M10; H07MA12 H023M12; H015M12			
V212			B300; B-12; HOH-300; HOH-12K; N-300; N-12; HOB-12; HJA6-12; NL-12 HLA6-12; HLA8-15; HLA6-15; NLT12 UVE315K		HA8-12; HX-12; H-12; SH-12; HH-12; HHL-12; HJ-12; HHJ-12; ZA8-12-78; ZA8-12-85 PC-12-93
N212; NT212; NB212	12" SURE-GRIP	H3KT12	B212; BT212; BL212 BB212; BLT212	LC315 KHF 315	
		H027M12; H037M12			

Serrated Soft Top Jaws

60° SERRATIONS

Material:

- Steel: 080M15 (En32) • Black Finish
- Aluminium: HE30TF • Natural Finish

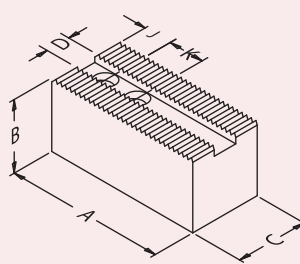

TYPE: **AS**- STEEL **AA** - ALUMINIUM

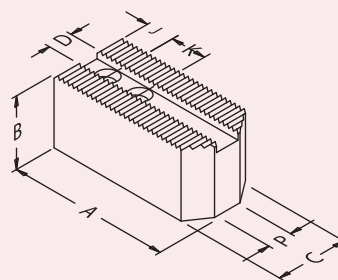

TYPE: **BS** - STEEL

Chuck Ø 265mm - 450mm

PART No.	JAW TYPE	A	B	C	D	K&J BOLT	P	SERRATIONS	WEIGHT Kg/Set
DU 10	AS	105	40	40	18	30+24 M14		1.5mm x 60°	4.4
DU 11	AS	105	60	40	18	30+24 M14			6.6
BO 12	AS	130	50	50	18	30+40 M14	10	1.5mm x 60°	6.8
AA 12	AA	130	51	51	18	30+40 M14			2.7
DJ 12	AS	130	80	50	18	30+40 M14			10.9
AB 12	AA	130	76	51	18	30+40 M14			4.1
DJ 14	AS	130	100	50	18	30+40 M14			13.6
AC 12	AA	130	102	51	18	30+40 M14			5.4
PT 12	BS	145	50	50	18	30+40 M14			7.3
CN 32	DS	132	76	240	18	30+30 M14			28.0
HN 32	DA	132	76	240	18	30+30 M14			10.0
HN 30	DA	132	100	240	18	30+30 M14			13.2
SG 12	ES	146	76	Ø304	18	30+34 M14	41.0		
AG 12	EA	146	76	Ø304	18	30+34 M14	15.0		
BR 13	AS	130	50	50	21	30+40 M16	10	1.5mm x 60°	6.5
AA 13	AA	130	51	51	21	30+40M16			2.5
DJ 13	AS	130	80	50	21	30+40M16			10.4
BD 13	AS	130	100	50	21	30+40 M16			13.0
AB 13	AA	130	76	51	21	30+40 M16			4.0
AC 13	AA	130	102	51	21	30+40 M16			5.2
PT 13	BS	145	50	50	21	30+40 M16			7.3
CN 33	DS	132	76	240	21	30+30 M16			28.0
HN 33	DA	132	76	240	21	30+30 M16			10.0
HN 34	DA	132	100	240	21	30+30 M16			13.2
SG 13	ES	147	76	Ø304	21	30+34 M16	41.0		
AG 13	EA	147	76	Ø304	21	30+34 M16	15.0		
DU 12	AS	111	60	50	21	35+25 M16		1.5mm x 60°	7.1

IMPORTANT: Allow for weight of Large Diamond/Segment Jaws at high R.P.M.'s as the grip loss due to the effect of centrifugal forces will be greater.

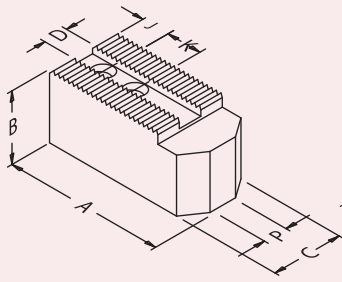

TYPE: **CS** - STEEL

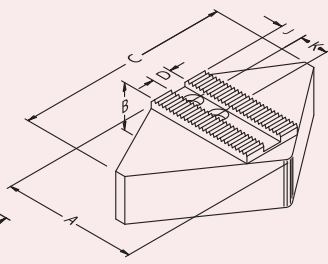

TYPE: **DS** - STEEL **DA** - ALUMINIUM

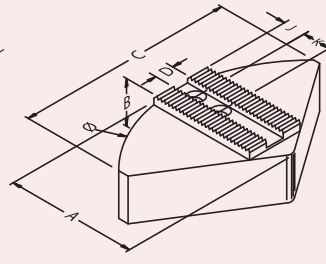

TYPE: **ES** - STEEL **EA** - ALUMINIUM

PRATT BURNERD	RÖHM	SAMCHULLY (POWER GRIP)	SEOAM (ACE)	SCHUNK	SMW-AUTOBLOK	TONFOU
305 CONSTANT GRIP 305 HIGH SPEED Q C		HC-12;HCH-12		ROTA NC/NCF 315; HSL 315		V-212;VA-212; VT-212
	KFD-HE 315	HS-12; HH212 MH-212	CAH-12	ROTA NCD 315; ROTA NCK 315; HSL 315; ROTA NCK plus 315; ROTA NC plus 315; ROTA NCF plus 315	AL-M 315; AN-M 315; BB-M 305; BB-M 315; BH-M 315; BHM-FC 315; GH-M 400; HB-M 305; HB-M 315; HFKN-M 315; PB-M 315; PBI-M 315; RC-M 305; RC-M 315; RC-M 400; AP-M 315; AP/NT-M315 APL-M315	TF3B-12

Serrated Soft Top Jaws

60° SERRATIONS

Material:

- Steel: 080M15 (En32) • Black Finish
- Aluminium: HE30TF • Natural Finish

Chuck Ø 450mm - 800mm

IMPORTANT: Allow for weight of Large Diamond/Segment Jaws at high R.P.M.'s as the grip loss due to the effect of centrifugal forces will be greater.

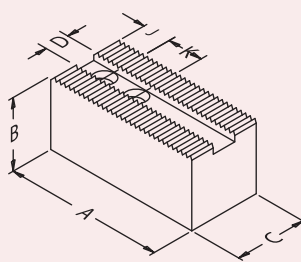

TYPE: **AS**-STEEL

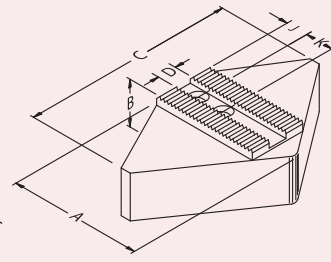

TYPE: **DS** - STEEL **DA** - ALUMINIUM

PART No.	JAW TYPE	A	B	C	D	K&J BOLT	P	SERRATIONS	WEIGHT Kg/Set
BO 15	AS	165	80	60	22	43+37 M20		1.5mm x 60°	15.2
BC 15	AS	165	100	60	22	43+37 M20			19.0
DJ 15	AS	165	125	60	22	43+37 M20			24.0
BE 15	AS	145	100	100	22	43+37 M20			28.0
BF 15	AS	205	80	60	22	43+37 M20			35.0
CN 38	DS	152	76	280	22	43+37 M20			48.0
HN 38	DA	152	76	280	22	43+37 M20			16.0
HN 39	DA	152	100	280	22	43+37 M20			21.1
BR 15	AS	135	60	50	25.5	43+26 M20		1.5mm x 60°	8.2
BR 16	AS	135	100	50	25.5	43+26 M20			15.5
BO 16	AS	156	80	60	22	60+36 M20		1.5mm x 60°	14.5
CK 15	AS	150	80	60	22	50+30 M20		3mm x 60°	13.8
BO 18	AS	180	80	60	25	60+40 M20		3mm x 60°	16.5
BC 18	AS	180	100	60	25	60+40 M20			20.6
DJ 18	AS	180	125	60	25	60+40 M20			26.5
BE 18	AS	160	100	100	25	60+40 M20			31.0
BO 24	AS	210	102	76	25	80+40 M20		3mm x 60°	32.3

AUTOSTRONG	HARDINGE (SURE GRIP)	HOWA	KITAGAWA	LEADER	MATSUMOTO (MMK)
N215;NT215			B380; B-15; HOH-380; HOB-15; HOH-15K; B-450; B-18; HOB-18		PC-15-120
V215;V218			B215; N15; N18 B218; BB218		
			HJ-380; HJA-18; HLA-18; HJA-8-21; UVE400K		
					HA11-15; HHL-15; H-15; HH-15; HA11-18; H-18; HH-18; ZA8-15-120
V221;V224			HJ-450; HJ18; B-350; B-21; HJ-530; HJ-21; HOB-21; N-21; B-600; B-24; HJ-610; HJ24; N24; HOB24; UVE-LB500/630		
			HOB24; HJA24; HJ24; UVE-LB800		

Serrated Soft Top Jaws

60° SERRATIONS

Material:

- Steel: 080M15 (En32) • Black Finish
- Aluminium: HE30TF • Natural Finish

Chuck Ø 450mm - 800mm

IMPORTANT: Allow for weight of Large Diamond/Segment Jaws at high R.P.M.'s as the grip loss due to the effect of centrifugal forces will be greater.

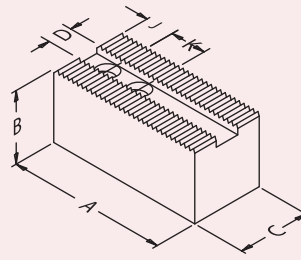

TYPE: AS-STEEL

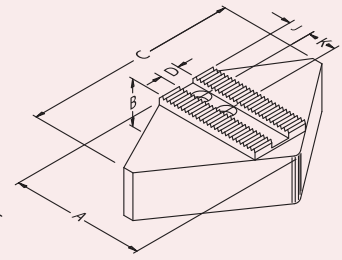

TYPE: DS - STEEL DA - ALUMINIUM

PART No.	JAW TYPE	A	B	C	D	K&J BOLT	P	SERRATIONS	WEIGHT Kg/Set
BO 15	AS	165	80	60	22	43+37 M20		1.5mm x 60°	15.2
BC 15	AS	165	100	60	22	43+37 M20			19.0
DJ 15	AS	165	125	60	22	43+37 M20			24.0
BE 15	AS	145	100	100	22	43+37 M20			28.0
BF 15	AS	205	80	60	22	43+37 M20			35.0
CN 38	DS	152	76	280	22	43+37 M20			48.0
HN 38	DA	152	76	280	22	43+37 M20			16.0
HN 39	DA	152	100	280	22	43+37 M20			21.1
BR 15	AS	135	60	50	25.5	43+26 M20		1.5mm x 60°	8.2
BR 16	AS	135	100	50	25.5	43+26 M20			15.5
BO 16	AS	156	80	60	22	60+36 M20		1.5mm x 60°	14.5
CK 15	AS	150	80	60	22	50+30 M20		3mm x 60°	13.8
BO 18	AS	180	80	60	25	60+40 M20		3mm x 60°	16.5
BC 18	AS	180	100	60	25	60+40 M20			20.6
DJ 18	AS	180	125	60	25	60+40 M20			26.5
BE 18	AS	160	100	100	25	60+40 M20			31.0
BO 24	AS	210	102	76	25	80+40 M20		3mm x 60°	32.3
BO 32	AS	210	102	76	25.5	80+40 M20		3mm x 60°	32.3

PRATT BURNERD	RÖHM	SAMCHULLY (POWER GRIP)	SEOAM (ACE)	SCHUNK	SMW-AUTOBLOK	TONFOU
380 INTERNATIONAL 380 HIGH SPEED Q C		HCH-15;HCH-18	CAH-15; CAH-18;	ROTA NC/NCF 400; HSL 400	BB-M-400 (with single T-nuts)	TF3B-15
		HC-15;HS-15; HC-18				V215;VA-215 VT-215
460 CONSTANT GRIP 500 CONSTANT GRIP 610 CONSTANT GRIP 460 HIGH SPEED Q C 500 HIGH SPEED Q C 610 HIGH SPEED Q C		HC-21; HC-24; HCH-21; HCH-24	CAH-21			
		HCH-32				

Diamond/Segment Jaws



- Can be turned or bored to clamp entire circumference of workpiece
- Choice of steel or aluminium types
- Diamond Jaws have greater flexibility than segment jaws, can be reversed
- Aluminium jaws – less weight for higher spindle speeds
- Helps stop distortion of thin walled components
- Can be machined to suit irregular parts

Distortion problems can be solved by using Diamond/Segment Jaws

Serrated Soft Top Jaws

60° SERRATIONS

Material:

- Steel: 080M15 (En32) • Black Finish

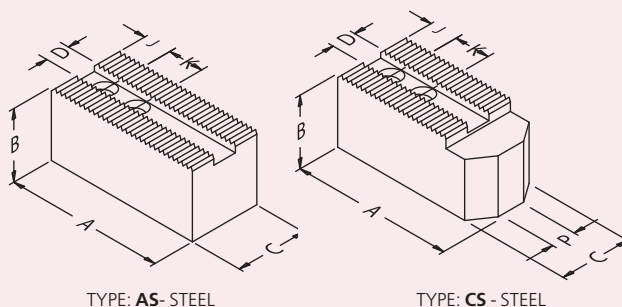

To suit • Howa HO1MA Chucks (3mm Serrations)

PART No.	JAW TYPE	A	B	C	D	K&J BOLT	SERRATIONS	WEIGHT Kg/Set
BP 06	AS	72	35	30	12	20+15 M10	3mm x 60°	1.4
BP 08	AS	95	40	35	14	25+25 M12	3mm x 60°	2.6
BP 10	AS	110	40	40	16	30+30 M12	3mm x 60°	3.4
BP 12	AS	130	50	50	18	30+40 M14	3mm x 60°	6.8

To suit • Gamet • Nikko • Röhm Power Chucks

PART No.	JAW TYPE	A	B	C	D	K&J BOLT	P	SERRATIONS	WEIGHT Kg/Set
DL 10	AS	50	30	20	10	15+9 M8		1.5mm x 60°	0.6
DL 16	AS	67	40	30	11	20+17 M8		1.5mm x 60°	1.6
BT 06	CS	77	35	25		20+9 M8	7		1.1
DL 22	AS	89	60	30	14	26+18 M10		1.5mm x 60°	3.1
BT 08	CS	102	40	30		22+10 M10	10		2.4
DL 28	AS	89	60	40	20	26+18 M12		1.5mm x 60°	4.1
BT 10	CS	117	50	40		30+13 M12	10		4.9
BT 11	CS	130	50	40		30+13 M12	10		5.4
DL 35	AS	120	80	50	21	28+25 M16		1.5mm x 60°	9.4
BT 14	CS	170	60	50		40+22 M16	18		10.0

Pointed or weight reduced soft jaws

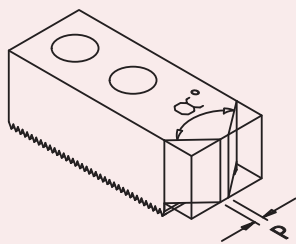

A. Pointed 60° or 120° Inclusive α°

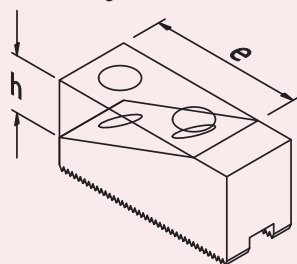

B. Rectangular Weight Reduced

Any standard soft jaw can be pointed or weight reduced, please give following information:-

1. Quantity of sets required.
2. Thame Part No.
3. Modification required.
4. Relevant dimensions.

HOWA CHUCK TYPRE

HO1MA6

HO1MA8

HO1MA10

HO1MA12

Conversion plates

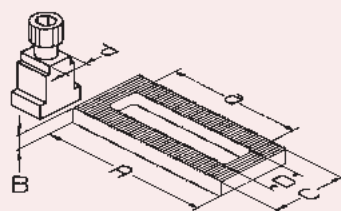

A. Serration to Serration

Allows different top jaws to be used with base jaws of another configuration. Please contact our sales office for a quotation.

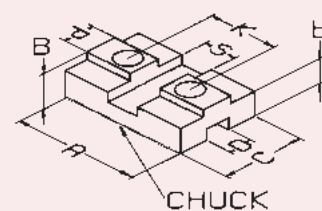

B. Serration to Slot/Tenon

GAMET		NIKKO		ROHM
105N		HF-4		KFD-HE 130
105 MO				KFN 105
140 DE	160 GO	GO-6	HDM-165	KFN 160
160 N	170 MF	H F-6AB	D-170	KFM 160
160 MO		HG-6AB		KFG 160
130 N	130MO	M0-6		KFE 170
170 DE	215 MF	GO-8	MO-8	KFN 215
215 N	MAC 165	HF-8		KFM 215
215 MO		HG-8		KFG 215
215GO		HDM 215		KFE 215
250 N		GO-10	HDM 250	KFN 250/280
280 N		GO-12	HDM 300	KFM 280
280 MO		HF-10	MO-10	KFG 280
280 GO		HF-12	MO-12	KFE 280
280 MF		HG-10		
350 N	MAC 250	HF-14	MO-14	KFN 350
350 GO	MAC 315	HF-16		KFM 350
350 MO		HDM 250		KFG 350
350 MF		HDM 380		KFE 350

Serrated Soft Top Jaws

90° SERRATIONS

Material:

- Steel: 080M15 (En32) • Black Finish
- Aluminium: HE30TF • Natural Finish

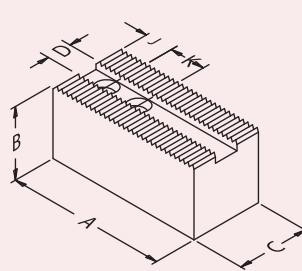

TYPE: **AS**-STEEL **AA** - ALUMINIUM

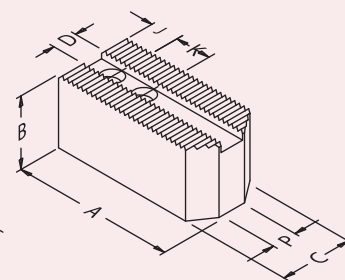

TYPE: **BS** - STEEL

Chuck Ø 125mm - 250mm

PART No.	JAW TYPE	A	B	C	D	K&J BOLT	P	SERRATIONS	WEIGHT Kg/Set
BV 13	AS	52	25	25	12	14+8 M8		1/16" x 90°	1.0
RD 13	AS	55	40	30	12	16+10 M8		1/16" x 90°	1.2
CL 12	AS	60	30	30		16+15 M8			1.0
BV 16	AS	72	40	30	12	20+10 M10		1/16" x 90°	1.4
CL 17	AS	80	40	30	14	20+19 M10		1/16" x 90°	2.2
BM 16	AS	65	40	40	17	22+15 M12	20	1/16" x 90°	1.3
BN 70	AS	70	60	40		22+15 M12			2.7
BN 75	BS	80	40	40		22+15 M12			2.5
RD 16A	AA	70	60	40		22+15 M12			1.1
CM 16	DS	60	60	120		22+15 M12			9.0
HL 16	DA	64	64	120		22+15 M12			3.2
CM 20	DS	89	64	150		22+15 M12			14.0
HL 20	DA	77	64	150		22+15 M12			5.0
BN 77	ES	80	80	Ø169		22+21.5 M12			13.0
BN 76	EA	80	80	Ø169		22+21.5 M12			6.0
BL 20	AS	64	40	40	17	25.4+13 M12	20	1/16" x 90°	1.6
BL 25	AS	80	50	40		25.4+13 M12			2.8
BN 80	AS	90	40	40		22+15 M12			2.8
BN 85	BS	90	40	40		22+15 M12			2.7
BN 90	AS	90	60	40		22+15 M12			3.7
RD 20A	AA	90	60	40		22+25 M12			1.5
CM 25	DS	102	64	170		22+20 M12			20.0
HL 25	DA	102	64	170		22+20 M12			7.0
BN 87	ES	95	76	Ø210		22+25 M12			21.0
BN 89	EA	99	76	Ø210		22+25 M12			7.0

IMPORTANT: Allow for weight of Large Diamond/Segment Jaws at high R.P.M.'s as the grip loss due to the effect of centrifugal forces will be greater.

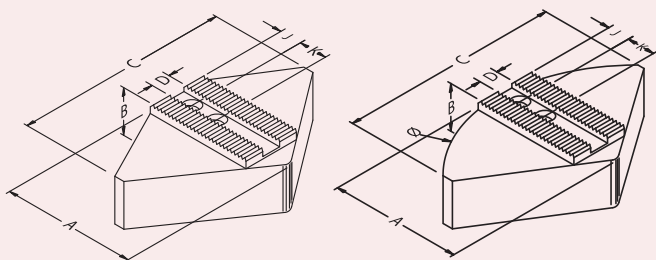

TYPE: **DS** - STEEL **DA** - ALUMINIUM

TYPE: **ES** - STEEL **EA** - ALUMINIUM

AUTOBLOK & SMW - AUTOBLOK	BERG	FORKARDT	GAMET
IN-D 125;AN-D 125;AL-D-125; GHDN 125 PB-D 130; PBI-D 130; BH-D 130; HB-D 130	KF 130	KTH 130; KTH 140	
IDN 170, HDB 170; IDL 170; HDN 170; GHDN 165; GHD-FC 165; AN-D 165; AL-D 165 HFKN-D 165; HYDN--S 180; PB-D 165 PBI-D 165; BB-D 175; BHD-FC 165; HB-D 165			MAC 165/170 DE 170 GA 160/170
AL-D 210;AN-D 210; BB-D 210; BH-D 210 BH-D FC 210; CD 200; GHD-FC 210 GHDN 210; HB-210; HDB 220; HDL 200 IDN 200; IDN 220; IDL 200; HDN 200; HDN 220; HDN 250S; PB-D 210; PBI-D 210 RC-D 210;	KF160; HES160; KHFF 200 KF 200; HES 200; HESF 160 HESF 200;	KGGH 160/175/200; KGGHF 160/175/200 KGG200; KL160; KLNC 200; KP 200 KS 160/200/250; KSF 175/200 KSH 160/200; KSHF 200; KSPS 160/200 KTG 160/200; KTGF 200 KTH 160/ 175/ 200; KTN 160/200 NH 160/175/200; NHF 160/175/200 QLC 160/175/200; QLC-KS 200; QLC-LS 160/200; QLC-AG 200; QLK 160 QLK 175/200; QLK-KS 200; UVE 160/200	MAC 200; MAC 220 DE 210; GA 210
AL-D 210;AN-D 210; BB-D 210; BH-D 210 BH-D FC 210; CD 200; GHD-FC 210 GHDN 210; HB-210; HDB 220; HDL 200 IDN 200; IDN 220; IDL 200; HDN 200; HDN 220; HDN 250S; PB-D 210; PBI-D 210 RC-D 210;	KF 200; HES 200; KHFF 200 HESF 200	KG 200; KGGH 200; KGGHF 200; KLNC 200 KP 200; KS 200/250; KSF 200; KSH 200 KSHF 200/250; KSPS 200; KT 200 KTG 200; KTGF 200; KTH 200; KTN 200 NH 200; NHF 200; QLC 200; QLC-KS 200/250; QLC-AG 200 QLC-LS 160/200; QLK 200; QLK-KS 200/250; UVE 200/250 NHF 250/290 (INDEX)	MAC 200; MAC 220 DE 210; GA 210

Serrated Soft Top Jaws

90° SERRATIONS

Material:

- Steel: 080M15 (En32) • Black Finish
- Aluminium: HE30TF • Natural Finish

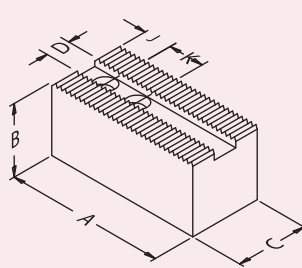

TYPE: **AS**- STEEL **AA** - ALUMINIUM

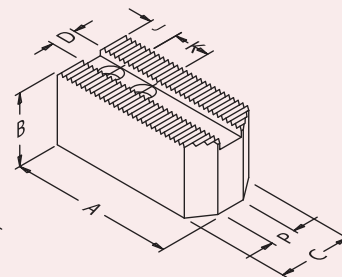

TYPE: **BS** - STEEL

Chuck Ø 125mm - 265mm

PART No.	JAW TYPE	A	B	C	D	K&J BOLT	P	SERRATIONS	WEIGHT Kg/Set
BV 13	AS	52	25	25	12	14+8 M8		1/16" x 90°	1.0
RD 13	AS	55	40	30	12	16+10 M8		1/16" x 90°	1.2
CL 12	AS	60	30	30		16+15 M8			1.0
BV 16	AS	72	40	30	12	20+10 M10		1/16" x 90°	1.4
CL 17	AS	80	40	30	14	20+19 M10		1/16" x 90°	2.2
BM 16	AS	65	40	40	17	22+15 M12	20	1/16" x 90°	1.3
BN 70	AS	70	60	40		22+15 M12			2.7
BN 75	BS	80	40	40		22+15 M12			2.5
RD 16A	AA	70	60	40		22+15 M12			1.1
CM 16	DS	60	60	120		22+15 M12			9.0
HL 16	DA	64	64	120		22+15 M12			3.2
CM 20	DS	89	64	150		22+15 M12			14.0
HL 20	DA	77	64	150		22+15 M12			5.0
BN 77	ES	80	80	Ø169		22+21.5 M12			13.0
BN 76	EA	80	80	Ø169		22+21.5 M12			6.0
BL 20	AS	64	40	40	17	25.4+13 M12	20	1/16" x 90°	1.6
BL 25	AS	80	50	40		25.4+13 M12			2.8
BN 80	AS	90	40	40		22+15 M12			2.8
BN 85	BS	90	40	40		22+15 M12			2.7
BN 90	AS	90	60	40		22+15 M12			3.7
RD 20A	AA	90	60	40		22+25 M12			1.5
CM 25	DS	102	64	170		22+20 M12			20.0
HL 25	DA	102	64	170		22+20 M12			7.0
BN 87	ES	95	76	Ø210		22+25 M12			21.0
BN 89	EA	99	76	Ø210		22+25 M12			7.0

IMPORTANT: Allow for weight of Large Diamond/Segment Jaws at high R.P.M.'s as the grip loss due to the effect of centrifugal forces will be greater.

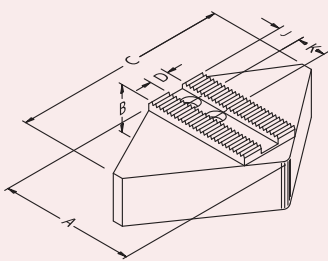

TYPE: **DS** - STEEL **DA** - ALUMINIUM

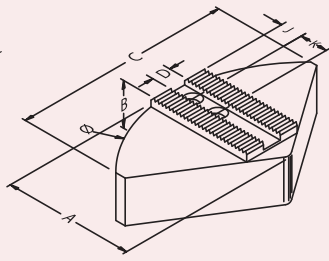

TYPE: **ES** - STEEL **EA** - ALUMINIUM

PRATT BURNERD	RÖHM	SCHUNK	SMW
125 INTERNATIONAL 150 KB INTERNATIONAL			
170 KB INTERNATIONAL	KFD 130; KFD-HE 170; KFH 140 KFD-HS 160/175; LVE 125/160	HSG 160; ROTA NCD 160/165	KDV 130 KMA 140 KMAF 140
135 HYD. FRONT END 165 INTERNATIONAL 165 CONSTANT GRIP 165 HIGH SPEED QC			
			SP 160
160 INTERNATIONAL 160 HIGH SPEED QC 165 HYD. FRONT END 210 INTERNATIONAL 210 HIGH SPEED QC 210 KB INTERNATIONAL 210 KB HIGH SPEED QC 210 CONSTANT GRIP	KFD 160; KFD-AF 160; KFD-HF 160; KFD-HS 200; KFH 160; KFH-F 160; KFH-G 160; KFH-HC 160 SPD 160; SPO 160	HSL 165 ROTA NC 165 ROTA NCD 185 ROTA NCF 165 TH 165 THF 165	HKKS 160/200 KDV 160/200/250 KDBG 160/200/250 KDM 160/200 KDM-F 160/200/250 KMA 160/200/250 KMAF 160/200/250 KFV160/200 SP 200 KFMF 160/200 HFK 160/200
200 INTERNATIONAL 200 HIGH SPEED QC 210 HYD. FRONT END 250 HIGH SPEED QC 254 INTERNATIONAL 265 HIGH SPEED QC 265 KB INTERNATIONAL 265 KB HIGH SPEED QC 254 CONSTANT GRIP	KFD 200; KFD-AF 200; KFD-HE 200; KFD-HF 200 KFD-HS 250; KFH 200; KFH-F 200 KFH-G 200; KFH-NC 200 KFL 250; LVE 200; SPD 215; SPO 215	HSL 210 ROTA NC 210; ROTA NCD 210 ROTA NCF 210; ROTA NCO 210; ROTA TP 200; TH 210; THF 210 TP 200; ROTA NCK 210/250 ROTA NC plus 215; ROTA NCF plus 215	HFKS 200 KDV 200/250 KDBG 200/250 KDM 200 KDM-F 200/250 KMA 200/250 KMA-F 200/250 KFV 200 KFMF 200 HFK 200

Serrated Soft Top Jaws

90° SERRATIONS

Material:

- Steel: 080M15 (En32) • Black Finish
- Aluminium: HE30TF • Natural Finish

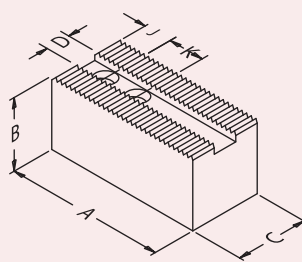

TYPE: **AS**- STEEL **AA** - ALUMINIUM

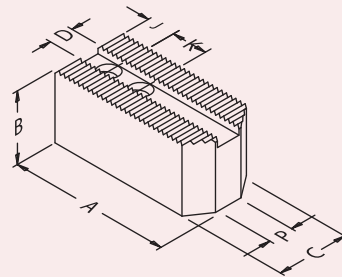

TYPE: **BS** - STEEL

Chuck Ø 250mm - 800mm

PART No.	JAW TYPE	A	B	C	D	K&J BOLT	P	SERRATIONS	WEIGHT Kg/Set
BL 32	AS	105	60	40	21	31.8+16 M16		1/16" x 90°	5.0
BM 32	AS	116	60	50		31.8+16 M16			7.6
BN 10	AS	120	50	50		28+20 M16		24	5.4
BN 11	BS	120	50	50		28+20 M16			5.3
BN 12	AS	120	80	50		28+30 M16			9.4
BN 14	AS	140	50	50		28+20 M16			6.3
BN 15	BS	140	50	50		28+20 M16	24		6.2
RD 25A	AA	120	80	50		28+30 M16			6.2
CM 26	DS	102	64	170		28+20 M16			20.0
HL 26	DA	103	64	170		28+20 M16			7.0
BN 17	ES	122	76	Ø254		28+28 M16			29.0
BN 19	EA	122	76	Ø254		28+28 M16			10.0
CM 32	DS	132	76	240		28+30 M16			28.0
HL 32	DA	132	76	240		28+30 M16			10.0
BN 13	AS	140	90	60	25.5	35+30 M20		1/16" x 90°	15.0
BM 40	AS	152	80	60	25.5	44.5+20 M20		3/32" x 90°	14.3
BN 23	AS	155	90	60		35+30 M20			17.4
RD 40A	AA	155	102	64		30+35 M20			6.5
CM 40	DS	153	76	280		35+32 M20			48.0
HL 40	DA	151	76	280		35+32 M20			16.0
BN 27	ES	178	76	Ø400		35+53 M20			64.0
BN 29	EA	178	76	Ø400		35+53 M20			21.0
BJ 50	AS	146	80	50	25.4	44.5+29 M20			3/32" x 90°
CL 50	AS	160	80	60	28	38+25 M20		3/32" x 90°	14.5

IMPORTANT: Allow for weight of Large Diamond/Segment Jaws at high R.P.M.'s as the grip loss due to the effect of centrifugal forces will be greater.

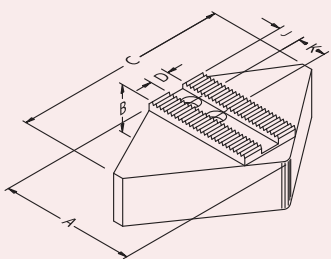

TYPE: **DS** - STEEL **DA** - ALUMINIUM

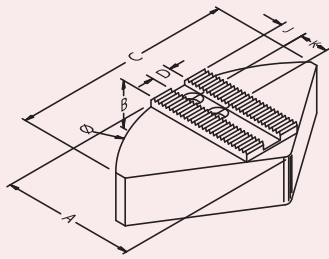

TYPE: **ES** - STEEL **EA** - ALUMINIUM

AUTOBLOK & SMW - AUTOBLOK	BERG	FORKARDT	GAMET
IDN 250; IDN 315; IDN 400; IDL 250; IDL 315 IDL 400; HDN 250; HDN 315; HDN 400 GHDN 250; GHDN 315; GHDN 400; CD 250 CD 315; GHD-FC 250; GHD-FC 305; GHD-FC 400; HDB 300; AN-D 250 AL-D 250; AN-D 315; AL-D 315; BB-D 250; BB-D 315; BH-D 250; BH-D 315 GH-D 400; HB-D 250; HB-D 315; HDB 300 HDL 250; HDL 315; HDL 400; HDN 250 HDN 315; HDN 400; HYDN-S 250; HYDN-S 315 PB-D 250; PB-D 315; PBI-D 250; PBI-D 315 RC-D 250; RC-D 305; RC-D 400	KF 250; HES 250; KHFF 250 HESF 250; KF 315; HES 315 KHFF 315; HESF 315	KG 250/315; KL 250; KLNC 250/315 KP 250/315; KS 315/400 KSH 250/315/400 KSHK 250/315/400; KSPS 250/300 KT 250/315; KTG 250/315; KTGF 250/315 KTN 250/315; NH 250/315; NHF 250/315 QLC 250/315; QLC-KS 315/400 QLC-LS 250/315; QLC-AG 250/315 QLK 250/315; QLK-KS 315/400 UVE 315; NHF 400(INDEX)	MAC 250; MAC 315 DE 250/260/320 GA 250/315
IDN 500; IDN 630; IDN 800 IDL 500; IDL 630; IDL 800 GHDN 500; GHDN 610; GHDN 640; GHDN 800 AL-D 400; AN-D 400 GH-D 500; GH-D 610; GH-D 800 IN-D 500; IN-D 630; IN-D 800 BB-N 400; BB-N 460; BB-N 500 BH-D 400; BH-D 450; BH-D 500; BH-D 630 BH-D 800; BHD-FC 500; BHD-FC 630	KF 400; KF 500; KF630 HES 400; HES 500; HES 630 KHFF 400; KFF 400; KFF 400; KFF 500; KFF 630; HESF 400; HESF 500; HESF 630	KL 300; KSHF 560 KG 400/500; KL 400/500; KLNC 400/500 KP 400/500; KS 500/630 KSH 500; KSHF 630; KSL 630 KS-PS 400; KTG 400/500/630 KTGF 400/500/630; KTN 400/500/630 NH 400/500/630; NHF 400/500/630 QLC 400; QLK 400; UVE 400/500/630/800	MAC 380 DE 400
IDN 500; IDN 630; IDN 800 (all pre 94) GHDN 500/610/640/800; HDL 500/630/800			

Serrated Soft Top Jaws

90° SERRATIONS

Material:

- Steel: 080M15 (En32) • Black Finish
- Aluminium: HE30TF • Natural Finish

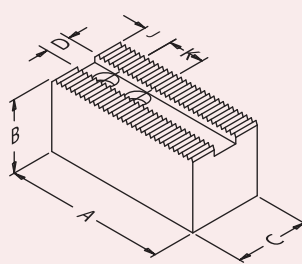

TYPE: **AS**- STEEL **AA** - ALUMINIUM

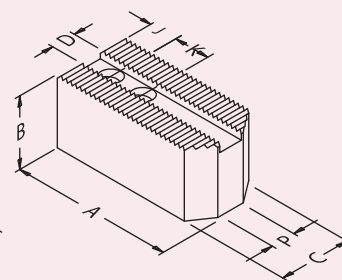

TYPE: **BS** - STEEL

Chuck Ø 250mm - 1000mm

PART No.	JAW TYPE	A	B	C	D	K&J BOLT	P	SERRATIONS	WEIGHT Kg/Set
BL 32	AS	105	60	40	21	31.8+16 M16		1/16" x 90°	5.0
BM 32	AS	116	60	50		31.8+16 M16			7.6
BN 10	AS	120	50	50		28+20 M16		24	5.4
BN 11	BS	120	50	50		28+20 M16			5.3
BN 12	AS	120	80	50		28+30 M16			9.4
BN 14	AS	140	50	50		28+20 M16			6.3
BN 15	BS	140	50	50		28+20 M16	24		6.2
RD 25A	AA	120	80	50		28+30 M16			6.2
CM 26	DS	102	64	170		28+20 M16			20.0
HL 26	DA	103	64	170		28+20 M16			7.0
BN 17	ES	122	76	Ø254		28+28 M16			29.0
BN 19	EA	122	76	Ø254		28+28 M16			10.0
CM 32	DS	132	76	240		28+30 M16			28.0
HL 32	DA	132	76	240		28+30 M16			10.0
BN 13	AS	140	90	60	25.5	35+30 M20		1/16" x 90°	15.0
BM 40	AS	152	80	60	25.5	44.5+20 M20		3/32" x 90°	14.3
BN 23	AS	155	90	60		35+30 M20			17.4
RD 40A	AA	155	100	60		30+35 M20			6.5
CM 40	DS	153	76	280		35+32 M20			48.0
HL 40	DA	151	76	280		35+32 M20			16.0
BN 27	ES	178	76	Ø400		35+53 M20			64.0
BN 29	EA	178	76	Ø400		35+53 M20			21.0
BJ 50	AS	146	80	50	25.4	44.5+29 M20			3/32" x 90°
CL 50	AS	160	80	60	28	38+25 M20		3/32" x 90°	14.5

IMPORTANT: Allow for weight of Large Diamond/Segment Jaws at high R.P.M.'s as the grip loss due to the effect of centrifugal forces will be greater.

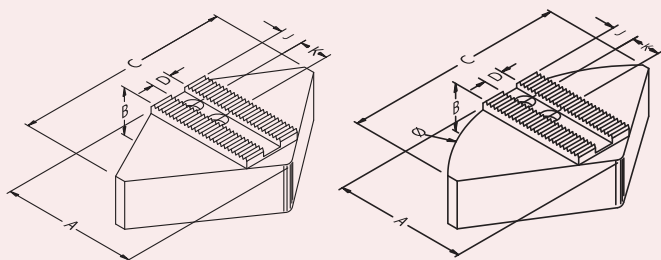

TYPE: **DS** - STEEL **DA** - ALUMINIUM

TYPE: **ES** - STEEL **EA** - ALUMINIUM

PRATT BURNERD	RÖHM	SCHUNK	SMW
250 INTERNATIONAL 254 HYD. FRONT END 305 HYD. FRONT END 305 INTERNATIONAL 305 HIGH SPEED QC 315 INTERNATIONAL 400 HIGH SPEED QC 305 KB INTERNATIONAL 305 KB HIGH SPEED QC 305 CONSTANT GRIP	KFD 250/315; KFD-AF 250/315 KFD-HE 254/315 KFD-HF 250/315 KFD-HS 315 KFH 250/315; KFH-F 250/315 KFH-G 250/315 KFH-NC 250/315 KFL 250/315 LVE 250/305/315 SPD 300; SPO 300	HSL 250; HSL 315; ROTA NC 250/315 ROTA NC plus 260/315; ROTA NCD 250; ROTA NCD 315 ROTA NCF 250; ROTA NCF 315 ROTA NCF plus 260/315 ROTA NCK plus 315 ROTA NCO 260/315 ROTA TP 250; ROTA TP 315 TH 250/315; THF 250/315	HFK 250/315 HFKS 250/315 KDV 315/400 KDBG 315/400 KDM 250/315/400 KDM-F 315/400 KMA 315/400 KMA-F 315
400 INTERNATIONAL 400 HYD. FRONT END 500 HYD. FRONT END	KFD 400/500/630/800 KFD-HE 400 KFD-HF 400/500/630 KFD-HS 400/500 KFH 400/500; KFH-F 400/500 KFH-G 400/500 KFH-NC 400/500 KFL 500/600 LVE 400/500/630/800/1000	HSG 400-500; HSL 400; ROTA NC 400 ROTA NC 500; ROTA NCD 400/500 ROTA NCF 400/500 ROTA NCO 400/500 TH 400; TH 500 THF 400; THF 500	HFK 400/500 HFKS 400/500 KDV 500 KDBG 500 KDM 500 KFV 400/500/630/800
380 INTERNATIONAL 380 HIGH SPEED QC			

Serrated Soft Top Jaws

90° SERRATIONS

Material:

- Steel: 080M15 (En32)
- Black Finish

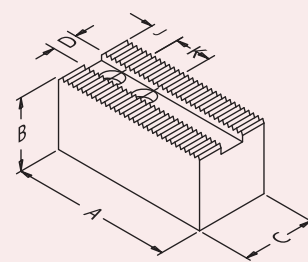

TYPE: AS - STEEL

To suit • SMW-Autoblok Large & Extra Large Open Centre Power Chucks

PART No.	JAW TYPE	A	B	C	D	K&J BOLT	SERRATIONS	WEIGHT Kg/Set	SMW-AUTOBLOK
CL 12	AS	60	30	30	12	16+15	1/16" x 90°	1.0	BH-D 130 BB-D 140
CI 12	AS	60	50	30		M8		1.6	AL-D 125 AN-D 125
CH 17	AS	70	40	30	14	16.5+16	1/16" x 90°	1.3	BH-D 165; BHD-FC 175; BB-D 175
CI 17	AS	70	60	30		M10		1.9	RC-D 165 AL-D 165 AN-D 165
CH 21	AS	90	40	40	17	23+20	1/16" x 90°	2.8	BH-D 210, BHD-FC 210; BBD 210
CI 21	AS	90	60	40		M12		4.2	RC-D 210 AL-D 210 AN-D 210
CH 25	AS	110	50	50	21	30+20	1/16" x 90°	3.8	BH-D 250, BHD-FC 250; BB-D 250
CI 25	AS	110	70	50		M16		5.3	RC-D 250 AL-D 250 AN-D 250
CH 32	AS	125	50	50	21	30+20	1/16" x 90°	5.5	BH-D 315; BND-FC 315; BB-D 315
CI 32	AS	125	80	50		M16		8.8	RC-D 315 AL-D 315 AN-D 315

To suit • Berg KH, KV & KHL Power Chucks

PART No.	JAW TYPE	A	B	C	D	K&J BOLT	SERRATIONS	WEIGHT Kg/Set	BERG
CS 11	AS	55	40	20	8	14+11 M8	1/16" x 90°	0.7	KH 110
CS 16	AS	70	50	25	10	20+15		1.4	KH 140-36; KH 140-45; KH 160
CS 17	AS	70	60	25		M10		1.8	KV 160; KHL 160
CS 18	AS	80	60	30	12	21+15 M12		3.6	KH 175-56; KH 200-68 KV 200; KHL 200
CS 20	AS	90	60	30	12	21+15 M12		3.8	KH 175-56; KH 200-68 KV 200; KHL 200
CS 25	AS	111	60	40	16	29+18		4.7	KH 250-91; KH 315-117
CS 26	AS	113	80	40		M16		6.2	KV 250; KV 315; KHL 250; KHL 315
CS 40	AS	150	80	50	20	38+31 M20	3/32" x 90°	8.4	KH 400; KH 500; KH 630 KV 400; KHL 400

Serrated Soft Top Jaws

90° SERRATIONS

Material:

- Steel: 080M15 (En32)
- Black Finish

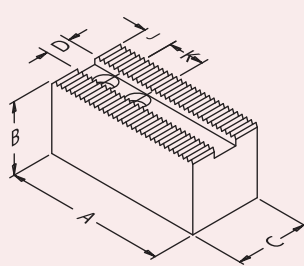

TYPE: AS - STEEL

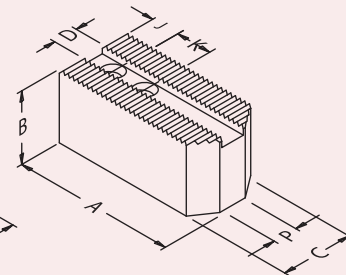

TYPE: BS - STEEL

To suit • Röhms KFD-HS
• Schunk HSG Power Chucks

PART No.	JAW TYPE	A	B	C	D	K&J BOLT	P	SERRATIONS	WEIGHT Kg/Set	RÖHM	SCHUNK
BI 13	BS	53	30	25	10	12+12+9 M6	3	1/16" x 90°	0.8	KFD-HS 130 KFD-HS 140	HSG 140
BI 14	BS	53	50	25	10	12+12+9 M6	3	1/16" x 90°	1.1	KFD-HS 130 KFD-HS 140	
BI 16	AS	55	40	30	12	15+9			1.9	KFD-HS 160 KFD-HS 175	HSG 160
BI 17	AS	55	60	30		M8			2.8		
BI 20	AS	70	60	40	17	19+12 M12			3.1	KFD-HS 200	HSG 200
BI 25	AS	90	60	40	17	19+12 M12			4.2	KFD-HS 250	HSG 250
BI 32	AS	105	60	50	21	25+15 M16			6.0	KFD-HS 315	HSG 315
BI 40	AS	140	90	60	25.5	31+20 M20		3/32" x 90°	14.5	KFD-HS 400 KFD-HS 500 HSG 500	HSG 400

To suit • Pratt Burnerd Constant Grip Power Chucks

PART No.	JAW TYPE	A	B	C	D	K&J BOLT	SERRATIONS	WEIGHT Kg/Set	PRATT BURNERD
BL 16	AS	50	40	30	15	20.6+11 M10	1/16" x 90°	1.0	160 TYPES 1770-/1771-/1772-
BL 20	AS	64	40	40	17	25.4+13 M12		1.6	200 TYPES 1770-/1771-/1772-
BL 25	AS	80	50	40	17	25.4+13 M12		2.8	250 TYPES 1770-/1771-/1772-
BL 32	AS	105	60	40	21	31.8+17 M16		5.0	315 TYPES 1770-/1771-/1772-
BL 40	AS	124	60	50	21	38.1+17 M16	3/32" x 90°	8.4	380 TYPES 1770-/1771-/1772-

Serrated Soft Top Jaws

90° SERRATIONS

Material:

- Steel: 080M15 (En32)
- Black Finish

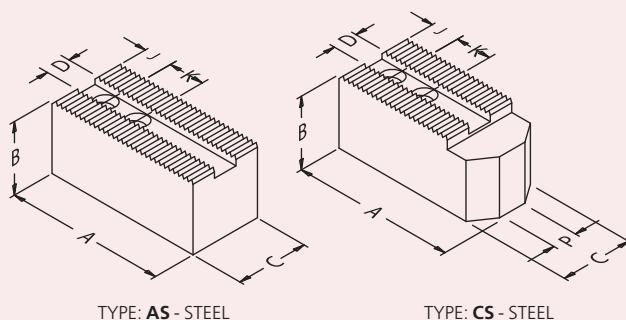

To suit • Schunk • SMW-Autoblok Pneumatic Power Chucks

PART No.	JAW TYPE	A	B	C	D	K&J BOLT	SERRATIONS	WEIGHT Kg/Set	SMW-AUTOBLOK	SCHUNK
CO 13	AS	68	40	30	11	18+21 M8	1/16" x 90°	1.6	SP 125/ STP 125/ STWP 125	TP 125
CO 16	AS	88	50	30	14	25+25 M10		2.9	SP 160/ STP 160/ STWP 160	TP 160
CO 20	AS	98	50	40	17	29+25 M12		4.0	SP 200 / STP 200 / LP 205 / STWP 200	TP 200
CO 25	AS	108	70	50	21	30+28 M14		8.0	SP 250 / STP 250 / LP 250 / STWP 250 SP315/ STP315/ LP305/ STWP315	TP 250/315
CO 32	AS	120	70	50	21	30+28 M14		10.1	SP315/ STP315/ LP305/ STWP315	TP 315
CO 35	AS	132	70	50	21	30+28 M14		11.5	SP315/ STP315/ STWP315	

To suit • Gamet Power Chucks

PART No.	JAW TYPE	A	B	C	D	K&J BOLT	P	SERRATIONS	WEIGHT Kg/Set	GAMET
BU 06	CS	77	35	25	11	20+9 M8	7	1/16" x 90°	1.1	160N / 160 MO / 160GP
BU 08	CS	102	40	30	14	22+10 M10	10		2.6	215 N / 215 MO / 215 GP
BU 11	CS	130	50	40	20	30+13 M12	10		5.4	250/280 N / 280 MO / 280 GP
BU 14	CS	170	60	50	21	40+22 M16	18		10.0	350 N / 350 MO / 350 GP

Serrated Soft Top Jaws

90° SERRATIONS

Material:

- Steel: 080M15 (En32)
- Black Finish

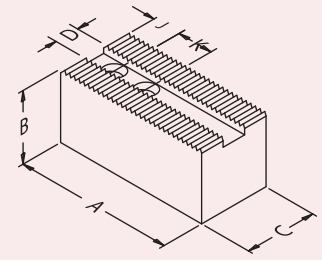

TYPE: AS - STEEL

To suit • Coventry • Tudor Manual Chucks

PART No.	JAW TYPE	A	B	C	D	K&J BOLT	SERRATIONS	WEIGHT Kg/Set	COVENTRY	TUDOR
AJ 06	AS	57	30	25	12.7	12.7+16	1/16" x 90°	0.9	6" & 7 1/2" Coventry	6 1/2" Tudor
AL 06	AS	67	50	25		5/16 BSW		1.8		
AJ 07	AS	64	30	25	14.3	17.5+21	1/16" x 90°	1.2		7 1/2" Tudor
AL 07	AS	76	50	25		3/8 BSW		2.1		
AJ 09	AS	70	40	30	15.9	15.9+21	1/16" x 90°	1.9	9" Coventry	9" Tudor
AL 09	AS	82	70	30		7/16 BSW		3.5		
AJ 12	AS	76	50	40	17.5	23+19	1/16" x 90°	2.8	12" Coventry	12" Tudor
AL 12	AS	102	80	40		1/2 BSW		5.7		
AJ 15	AS	95	60	40	20.6	30.2+25.4	1/16" x 90°	4.4	15" Coventry	15" Tudor
AL 15	AS	121	90	40		5/8 BSW		9.0		
AJ 18	AS	108	60	50	25.4	34.9+27	3/32" x 90°	7.0	18" Coventry	18" Tudor
AL 18	AS	140	90	50		3/4 BSW		12.9		
AJ 21	AS	140	80	50	25.4	41.3+43	3/32" x 90°	12.0	21" Coventry	21" Tudor
AL 21	AS	171	125	50		3/4 BSW		24.0		
AJ 25	AS	155	80	50	25.4	54+41	3/32" x 90°	14.3	25" Coventry	25" Tudor
AL 25	AS	197	125	50		3/4 BSW		33.2		29" Tudor

Serrated Soft Top Jaws

90° SERRATIONS

Material:

- Steel: 080M15 (En32)
- Black Finish

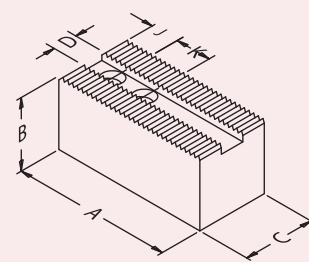

TYPE: AS - STEEL

To suit • Autoblok • Forkardt • Röhms
• Schunk • SMW 2 Jaw Chucks

PART No.	JAW TYPE	A	B	C	D	K&J BOLT	SERRATIONS	WEIGHT Kg/Set
DS 20	AS	95	70	70	21	27+22 M16	1/16" x 90°	7.2
DS 25	AS	110	70	70	25.5	35+20 M20	1/16" x 90°	7.6
DS 32	AS	125	80	80	25.5	35+28 M20	1/16" x 90°	10.6
DS 40	AS	150	80	80	25.5	35+28 M20	1/16" x 90°	13.0

To suit • Schunk • SMW-Autoblok Big Bore Power Chucks

PART No.	JAW TYPE	A	B	C	D	K&J BOLT	SERRATIONS	WEIGHT Kg/Set
CP 40	AS	155	80	60	25.5	40+35 M20	3/32" X 90°	15.0
CP 50	AS	185	80	60	25.5	40+35 M20	3/32" X 90°	18.0
CP 63	AS	240	102	76	30	64+40 M24	3/32" X 90°	35.0
CP80	AS	300	102	76	30	64+40 M24	3/32" X 90°	43.0

Serrated Soft Top Jaws

90° SERRATIONS

Material:

- Steel: 080M15 (En32)
- Black Finish

AUTOBLOK	FORKARDT	ROHM	SCHUNK	SMW
2CLD 200	2BLE 200	KFD-G-200 KFA 200	2B 200	KZF 200
2CLD 250	2BLE 250	KFD-G-250 KFA 250	2B 250	KZF 250
2CLD 315	2BLE 315	KFD-G-315 KFA315	2B 315	KZF 315
	2BLE 400 2BLE 500	KFD-G-400	2B 400	KZF 400

SMW-AUTOBLOK	SCHUNK
BB400 / BB400-ES / STP 400 / LP 380-460	ROTA EP 380 ROTA TB 400 TB 400
BB500 / BB500-ES, BB630-ES265 LP 500 / STP 500	ROTA EP 460 ROTA TB 500/ 610 ROTA TB 630-265 LH TB 500
BB630 / BB630-ES325 / STP 630 BB-N 630	ROTA NC 630 ROTA TB 630-265 LH ROTA TB 630-310 ROTA TB 630-325LH
BB800 / BB 1000 / STP 800 BB850-1000 ES BB-N 800/1000	ROTA TB800/850/1000/1200 TB 800/1000/1200

Serrated Hard
Top Jaws

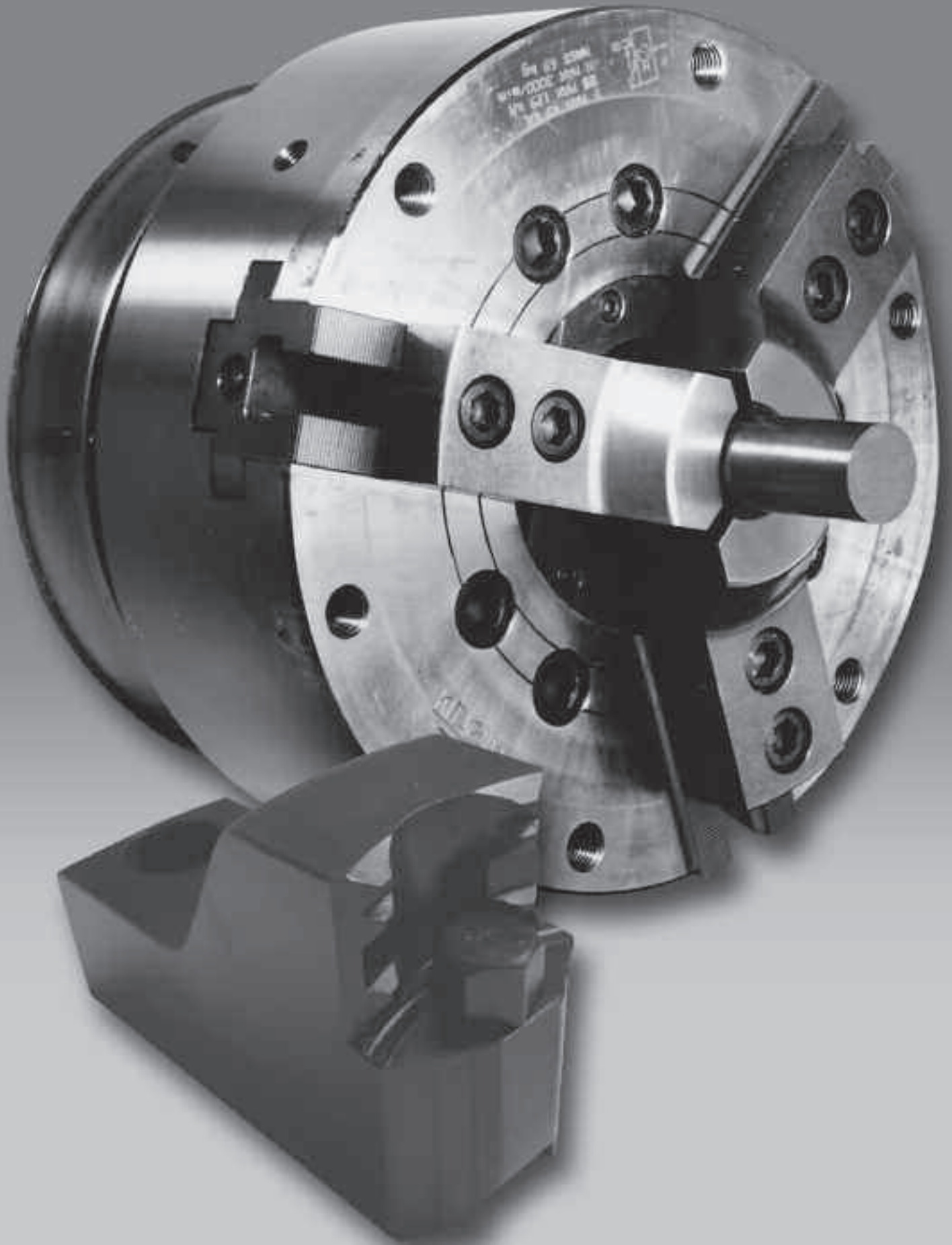

Serrated Hard Top Jaws

Page

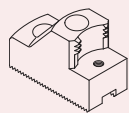

Adjustagrip Hard Jaws

- External clamping
- 60° serrations
- 90° serrations

45 - 89

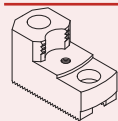

Adjustagrip Hard Jaws

- Internal clamping
- 60° serrations
- 90° serrations

45 - 89

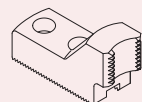

Adjustagrip Bar Jaws

- Bar clamping
- 60° serrations
- 90° serrations

45 - 89



Hard Reversible Jaws

- 2 or 3 step
- 60° serrations
- 90° serrations

90 - 103

Serrated Hard Top Jaws

	External Grip Adjustagrip 60° Serrations	Internal Grip Adjustagrip 60° Serrations	Bar Gripping Adjustagrip 60° Serrations	External Grip Adjustagrip 90° Serration	Internal Grip Adjustagrip 90° Serration	Bar Gripping Adjustagrip 90° Serration	Hard Reversible Jaws
	Page	Page	Page	Page	Page	Page	Page
AUTOBLOK							100-101
AUTOSTRONG	45-47	45-47	45-47				90-91, 94-95
BERG				77			99, 100-101
FORKARDT				78-82	78-82	78-82	99, 100-101
HARDINGE							90-91, 94-95
HOWA	48	48	48				90-91, 94-95, 98
KITAGAWA	49-54	49-54	49-54				90-91, 94-95
LEADER							90-91, 94-95
MMK MATSUMOTO	55-57	55-57	55-57				98
PRATT BURNERD	58-60	58-60	58-60				90-91, 94-95, 102-103
RÖHM				83-84	83-84	83-84	92-93, 96-97, 102-103
SAMCHULLY	61-63	61-63	61-63				92-93, 96-97
SCHUNK	64-67	64-67	64-67	85-88	85-88	85-88	92-93, 96-97, 102-103
SEOAM	68-69	68-69	68-69				92-93, 96-97
SMW							102-103
SMW-AUTOBLOK	70-73	70-73	70-73	89	89	89	92-93, 96-97, 100-101
TONFOU	74-76	74-76	74-76				92-93, 96-97

Adjustagrip Hard Top Jaws

Adjustagrip hard jaws are designed to provide maximum grip during 1st operation workholding applications- these jaws allow increased feed rates, depth of cut and reduce cycle times, compared to using standard hard reversible or soft jaws.

Ideal for rough castings and raw stock material.

Serrated Hard
Top Jaws



- The serious Hard Jaws for heavy machining.
- One set will grip various gripping diameters
- Clamping depth varied by a range of height pins
- Six Radial gripping teeth per jaw for high transmission and greater safety
- Lightweight design allows higher RPM's giving more grip
- Made with alloy steel for strength and durability
- External or Internal Gripping styles & Bar Jaws available
- Proven product over 20 years in the market
- Stock or short delivery for standard ranges

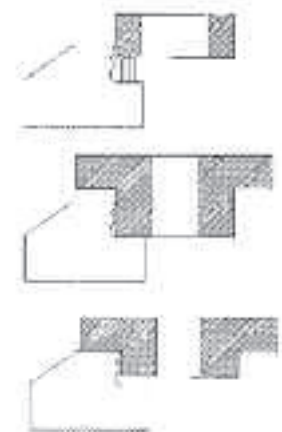
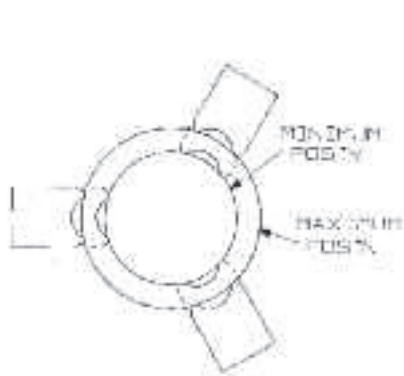
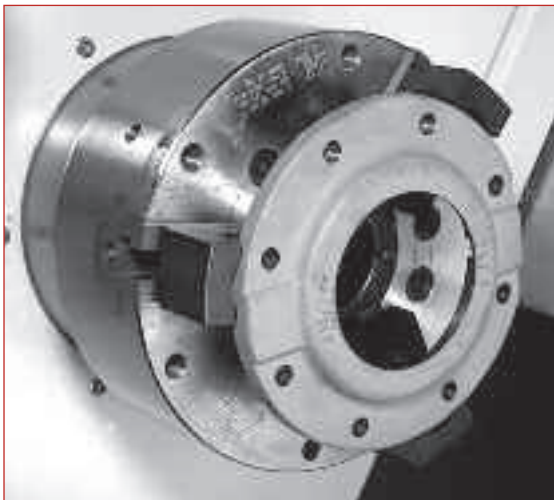

Adjustagrip Hard Top Jaws

To suit Power Chucks
60° SERRATIONS

Material:

- Steel: 590M17

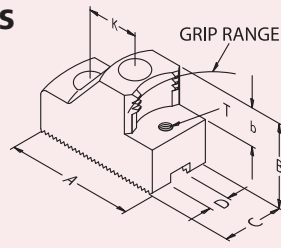

EXTERNAL GRIP

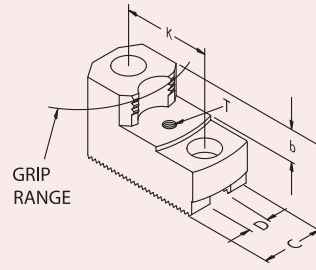

INTERNAL GRIP

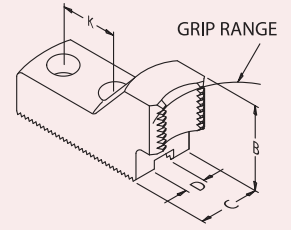

BAR GRIPPING

Serrated Hard Top Jaws

To suit • Auto-Strong Chuck Series N-200

CHUCK Ø	TYPE	EXTERNAL GRIP RANGES	EXTERNAL GRIP JAW PART No	INTERNAL GRIP RANGES	INTERNAL GRIP JAW PART No	B	C	D	K	b	T	SERRATION
169	N-206	14 - 31	KK 16 (Bar Jaw)			39	35	12	20			1.5mm x 60°
		27 - 44	LA 03	46 - 66	MA 05	49	35	12	20	20	M6	
		40 - 64	LA 04	53 - 77	MA 06							
		54 - 78	LA 06	71 - 97	MA 07							
		68 - 93	LA 07	94 - 119	MA 09							
		84 - 109	LA 09									
210	N-208	18 - 44	KK 20 (Bar Jaw)			49	40	14	25			1.5mm x 60°
		39 - 67	LB 03	57 - 85	MB 06	49	40	14	25	20	M6	
		67 - 95	LB 06	85 - 118	MB 08							
		95 - 124	LB 09	118 - 150	MB 11							
		123 - 151	LB 12	148 - 178	MB 14							
254	N-210	29 - 63	KK 25 (Bar Jaw)			49	40	16	30			1.5mm x 60°
		48 - 86	LC 04	65 - 104	MC 06	59	40	16	30	25	M8	
		86 - 129	LC 08	104 - 145	MC 10							
		129 - 172	LC 13	145 - 185	MC 14							
		172 - 215	LC 17	185 - 222	MC 18							
304	N-212	33 - 86	KK 33 (Bar Jaw)			49	50	21	30			1.5mm x 60°
		55 - 110	LE 05	86 - 149	ME 08	59	50	21	30	25	M8	
		109 - 172	LE 10	149 - 207	ME 14							
		172 - 237	LE 16	207 - 270	ME 20							
		239 - 300	LE 23	269 - 330	ME 26							

Workpiece Height Pins

See page 165



Adjustagrip Jaws are available on request in special sizes or to suit other chuck types.

Adjustagrip Hard Top Jaws

To suit Power Chucks
60° SERRATIONS

Material:

- Steel: 590M17

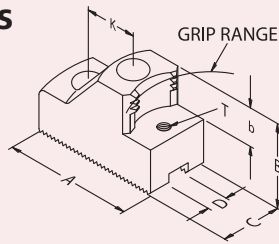

EXTERNAL GRIP

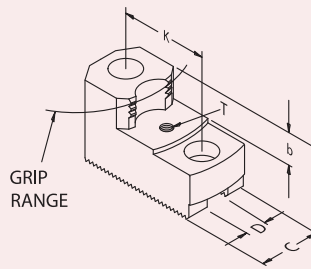

INTERNAL GRIP

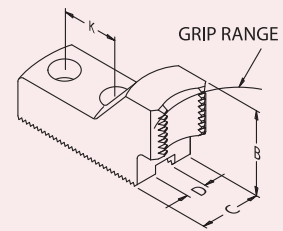

BAR GRIPPING

To suit • Auto-Strong Chuck Series NB-200A

CHUCK Ø	TYPE	EXTERNAL GRIP RANGES	EXTERNAL GRIP JAW PART No	INTERNAL GRIP RANGES	INTERNAL GRIP JAW PART No	B	C	D	K	b	T	SERRATION	
170	NB-206	14 - 26	KK 16 (Bar Jaw)			39	35	12	20			1.5mm x 60°	
		27 - 44	LA 03	46 - 62	MA 05	49	35	12	20	20	M6		
		44 - 60	LA 04	57 - 76	MA 06								
		58 - 74	LA 06	76 - 95	MA 07								
		72 - 89	LA 07	98 - 115	MA 09								
		89 - 105	LA 09										
210	NB-208	25 - 46	KK 20 (Bar Jaw)			49	40	14	25			1.5mm x 60°	
		47 - 75	LB 03	64 - 93	MB 06	49	40	14	25	20	M6		
		75 - 103	LB 06	93 - 123	MB 08								
		103 - 131	LB 09	126 - 155	MB 11								
		130 - 156	LB 12	155 - 184	MB 14								
254	NB-210	32 - 67	KK 25 (Bar Jaw)			49	40	16	30			1.5mm x 60°	
		52 - 90	LC 04	69 - 108	MC 06	59	40	16	30	25	M8		
		90 - 133	LC 08	108 - 148	MC 10								
		133 - 176	LC 13	149 - 190	MC 14								
		176 - 216	LC 17	188 - 230	MC 18								
315	NB-212	59 - 103	KK 33 (Bar Jaw)			49	50	21	30			1.5mm x 60°	
		83 - 130	LE 05	115 - 164	ME 08	59	50	21	30	25	M8		
		137 - 187	LE 10	178 - 229	ME 14								
		202 - 252	LE 16	237 - 288	ME 20								
		269 - 320	LE 23	299 - 350	ME 26								

Workpiece Height Pins

See page 165



Adjustagrip Jaws are available on request in special sizes or to suit other chuck types.

Adjustagrip Hard Top Jaws

To suit Power Chucks
60° SERRATIONS

Material:

- Steel: 590M17

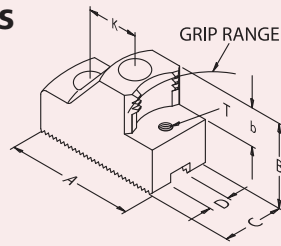

EXTERNAL GRIP

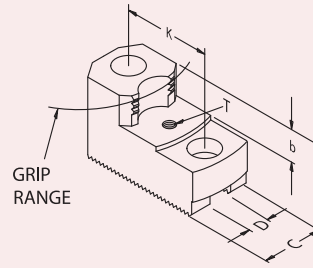

INTERNAL GRIP

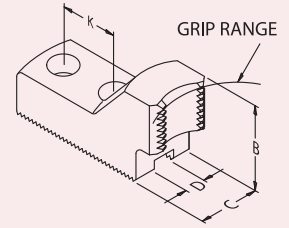

BAR GRIPPING

Serrated Hard Top Jaws

To suit • Auto-Strong Chuck Series V

CHUCK Ø	TYPE	EXTERNAL GRIP RANGES	EXTERNAL GRIP JAW PART No	INTERNAL GRIP RANGES	INTERNAL GRIP JAW PART No	B	C	D	K	b	T	SERRATION
165	V-206	17 - 27	KK 16 (Bar Jaw)			39	35	12	20			1.5mm x 60°
		31 - 45	LA 03	52 - 63	MA 05	49	35	12	20	20	M6	
		50 - 65	LA 04	63 - 78	MA 06							
		64 - 79	LA 06	82 - 98	MA 07							
		79 - 94	LA 07	104 - 116	MA 09							
		94 - 110	LA 09									
210	V-208	25 - 44	KK 20 (Bar Jaw)			49	40	14	25			1.5mm x 60°
		48 - 72	LB 03	65 - 90	MB 06	49	40	14	25	20	M6	
		75 - 100	LB 06	94 - 120	MB 08							
		104 - 130	LB 09	127 - 153	MB 11							
		131 - 155	LB 12	156 - 180	MB 14							
254	V-210	25 - 58	KK 25 (Bar Jaw)			49	40	16	30			1.5mm x 60°
		44 - 80	LC 04	60 - 99	MC 06	59	40	16	30	25	M8	
		80 - 123	LC 08	99 - 139	MC 10							
		123 - 166	LC 13	139 - 180	MC 14							
		166 - 205	LC 17	179 - 220	MC 18							
304	V-212	28 - 91	KK 32 (Bar Jaw)			49	50	18	30			1.5mm x 60°
		54 - 120	LD 05	82 - 151	MD 08	59	50	18	30	25	M8	
		111 - 179	LD 11	143 - 213	MD 14							
		175 - 244	LD 17	204 - 274	MD 20							
		237 - 308	LD 23	261 - 332								

Adjustagrip Jaws are available on request in special sizes or to suit other chuck types.

Adjustagrip Hard Top Jaws

To suit Power Chucks
60° SERRATIONS

Material:

- Steel: 590M17

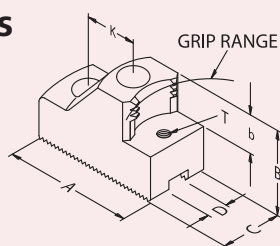

EXTERNAL GRIP

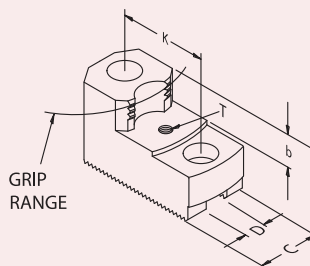

INTERNAL GRIP

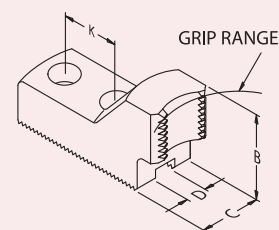

BAR GRIPPING

To suit • Howa Chuck Series H3KT

CHUCK Ø	TYPE	EXTERNAL GRIP RANGES	EXTERNAL GRIP JAW PART No	INTERNAL GRIP RANGES	INTERNAL GRIP JAW PART No	B	C	D	K	b	T	SERRATION
169	H3KT06	14 - 31	KK 16 (Bar Jaw)			39	35	12	20			1.5mm x 60°
		27 - 45	LA 03	45 - 66	MA 05	49	35	12	20	20	M6	
		40 - 64	LA 04	52 - 77	MA 06							
		54 - 79	LA 06	70 - 97	MA 07							
		68 - 93	LA 07	93 - 119	MA 09							
		84 - 110	LA 09									
210	H3KT08	18 - 45	KK 20 (Bar Jaw)			49	40	14	25			1.5mm x 60°
		39 - 68	LB 03	56 - 84	MB 06	49	40	14	25	20	M6	
		68 - 95	LB 06	85 - 114	MB 08							
		95 - 124	LB 09	118 - 147	MB 11							
		123 - 152	LB 12	147 - 177	MB 14							
254	H3KT10	29 - 64	KK 25 (Bar Jaw)			49	40	16	30			1.5mm x 60°
		48 - 86	LC 04	64 - 103	MC 06	59	40	16	30	25	M8	
		86 - 129	LC 08	103 - 144	MC 10							
		129 - 172	LC 13	144 - 186	MC 14							
		172 - 211	LC 17	184 - 225	MC 18							
304	H3KT12	33 - 87	KK 33 (Bar Jaw)			49	50	21	30			1.5mm x 60°
		55 - 111	LE 05	85 - 149	ME 08	59	50	21	30	25	M8	
		109 - 172	LE 10	149 - 210	ME 14							
		172 - 239	LE 16	207 - 270	ME 20							
		239 - 305	LE 23	269 - 330	ME 26							

Adjustagrip Jaws are available on request in special sizes or to suit other chuck types.

Adjustagrip Hard Top Jaws

To suit Power Chucks
60° SERRATIONS

Material:

- Steel: 590M17

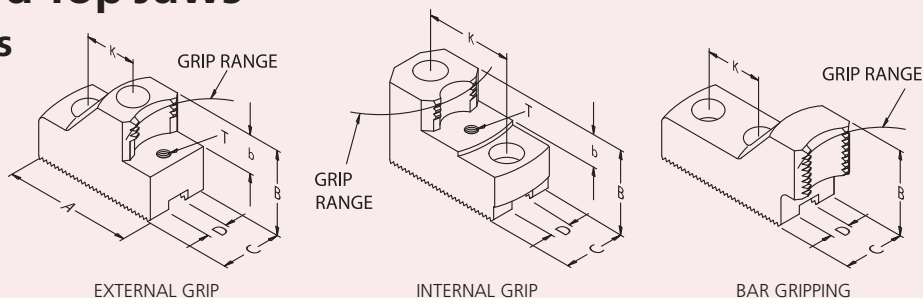

Serrated Hard Top Jaws

To suit • Kitagawa Chuck Series B200

CHUCK Ø	TYPE	EXTERNAL GRIP RANGES	EXTERNAL GRIP JAW PART No	INTERNAL GRIP RANGES	INTERNAL GRIP JAW PART No	B	C	D	K	b	T	SERRATION
169	B206	13 - 33	KK 16 (Bar Jaw)			39	35	12	20			1.5mm x 60°
		26 - 47	LA 03	45 - 69	MA 05	49	35	12	20	20	M6	
		37 - 67	LA 04	49 - 80	MA 06							
		50 - 81	LA 06	68 - 99	MA 07							
		64 - 96	LA 07	90 - 122	MA 09							
		80 - 112	LA 09									
210	B208	16 - 45	KK 20 (Bar Jaw)			49	40	14	25			1.5mm x 60°
		31 - 68	LB 03	50 - 85	MB 06	49	40	14	25	20	M6	
		60 - 96	LB 06	78 - 115	MB 08							
		87 - 125	LB 09	110 - 148	MB 11							
		114 - 152	LB 12	139 - 178	MB 14							
254	B210	25 - 65	KK 25 (Bar Jaw)			49	40	16	30			1.5mm x 60°
		44 - 85	LC 04	61 - 103	MC 06	59	40	16	30	25	M8	
		82 - 125	LC 08	100 - 143	MC 10							
		125 - 169	LC 13	140 - 185	MC 14							
		168 - 212	LC 17	180 - 224	MC 18							
304	B212	27 - 88	KK 33 (Bar Jaw)			49	50	21	30			1.5mm x 60°
		48 - 112	LE 05	78 - 145	ME 08	59	50	21	30	25	M8	
		102 - 168	LE 10	142 - 209	ME 14							
		165 - 233	LE 16	201 - 269	ME 20							
		232 - 300	LE 23									

Workpiece Height Pins

See page 165



Adjustagrip Jaws are available on request in special sizes or to suit other chuck types.

Adjustagrip Hard Top Jaws

To suit Power Chucks
60° SERRATIONS

Material:

- Steel: 590M17

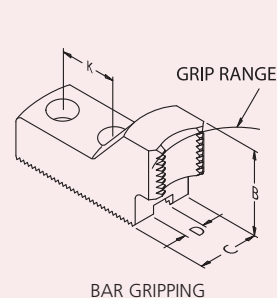
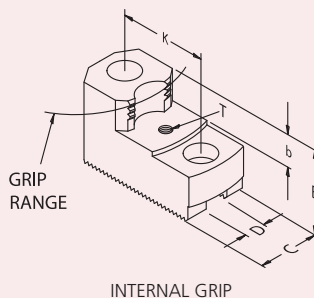
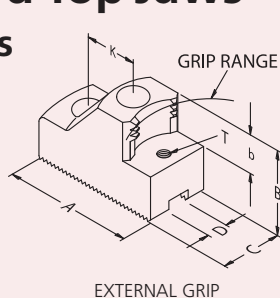

To suit • Kitagawa Chuck Series B/BA/HOH

CHUCK Ø	TYPE	EXTERNAL GRIP RANGES	EXTERNAL GRIP JAW PART No	INTERNAL GRIP RANGES	INTERNAL GRIP JAW PART No	B	C	D	K	b	T	SERRATION
165	B-06	13 - 29	KK 16 (Bar Jaw)			39	35	12	20			1.5mm x 60°
	HOH-206	31 - 62	LA 04	47 - 76	MA 06	49	35	12	20	20	M6	
		50 - 77	LA 06	67 - 95	MA 07							
		64 - 91	LA 07	83 - 117	MA 09							
		73 - 108	LA 09									
210	B-08	16 - 41	KK 20 (Bar Jaw)			49	40	14	25			1.5mm x 60°
	HOH-208	25 - 65	LB 03	50 - 82	MB 06	49	40	14	25	20	M6	
		54 - 93	LB 06	72 - 112	MB 08							
		81 - 121	LB 09	104 - 145	MB 11							
		108 - 149	LB 12	133 - 174	MB 14							
254	B-10	23 - 62	KK 25 (Bar Jaw)			49	40	16	30			1.5mm x 60°
	HOH-10K	41 - 81	LC 04	57 - 100	MC 06	59	40	16	30	25	M8	
		78 - 121	LC 08	96 - 140	MC 10							
		121 - 165	LC 13	137 - 181	MC 14							
		164 - 209	LC 17	176 - 221	MC 18							
304	B-12	27 - 86	KK 32 (Bar Jaw)			49	50	18	30			1.5mm x 60°
	HOH-12K	46 - 114	LD 05	74 - 145	MD 08	59	50	18	30	25	M8	
		102 - 174	LD 11	134 - 207	MD 14							
		165 - 239	LD 17	195 - 296	MD 20							
		228 - 302	LD 23									
381	B-15	50 - 108	LF 05	100 - 162	MF 10	79	60	22	43	33	M8	1.5mm x 60°
	HOH-15K	99 - 162	LF 10	160 - 224	MF 16							
		160 - 224	LF 16	222 - 287	MF 22							
		220 - 285	LF 22	280 - 345	MF 28							
		279 - 345	LF 28									
		339 - 404	LF 34									
450	B-18	50 - 170	LF 05	100 - 225	MF 10	79	60	22	43	33	M8	1.5mm x 60°
		100 - 225	LF 10	160 - 288	MF 16							
		160 - 288	LF 16	222 - 351	MF 22							
		221 - 349	LF 22	279 - 409	MF 28							
		280 - 409	LF 28	338 - 469	MF 34							
		339 - 469	LF 34									
530	B-21	80 - 202	LG 10	100 - 225	MG 10	79	60	25	60	33	M8	3.0mm x 60°
		196 - 324	LG 15	218 - 347	MG 15							
		319 - 449	LG 20	340 - 470	MG 20							
610	B-24	96 - 279	LG 10	118 - 303	MG 10	79	60	25	60	33	M8	3.0mm x 60°
		214 - 403	LG 15	237 - 426	MG 15							
		337 - 527	LG 20	359 - 549	MG 20							

Adjustagrip Jaws are available on request in special sizes or to suit other chuck types.

Adjustagrip Hard Top Jaws

To suit Power Chucks
60° SERRATIONS

Material:

- Steel: 590M17

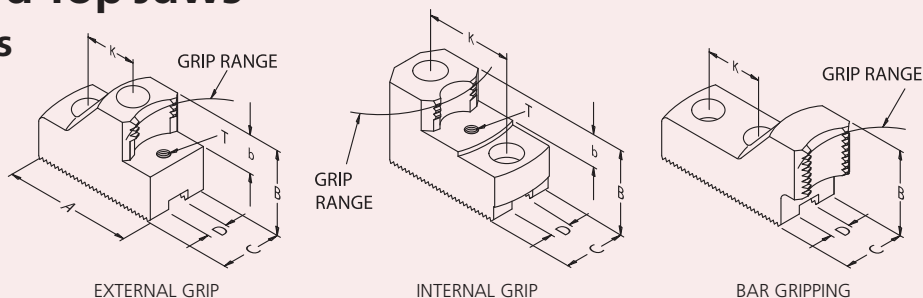

Serrated Hard Top Jaws

To suit • Kitagawa Chuck Series BB

CHUCK Ø	TYPE	EXTERNAL GRIP RANGES	EXTERNAL GRIP JAW PART No	INTERNAL GRIP RANGES	INTERNAL GRIP JAW PART No	B	C	D	K	b	T	SERRATION
170	BB206	16 - 35	KK 16 (Bar Jaw)			39	35	12	20			1.5mm x 60°
		30 - 49	LA 03	51 - 71	MA 05	49	35	12	20	20	M6	
		49 - 69	LA 04	62 - 82	MA 06							
		63 - 83	LA 06	81 - 102	MA 07							
		77 - 98	LA 07	103 - 124	MA 09							
		94 - 114	LA 09									
210	BB208	24 - 49	KK 20 (Bar Jaw)			49	40	14	25			1.5mm x 60°
		46 - 73	LB 03	63 - 92	MB 06	49	40	14	25	20	M6	
		73 - 101	LB 06	92 - 125	MB 08							
		101 - 130	LB 09	125 - 154	MB 11							
		130 - 157	LB 12	154 - 183	MB 14							
254	BB210	33 - 72	KK 25 (Bar Jaw)			49	40	16	30			1.5mm x 60°
		52 - 91	LC 04	70 - 110	MC 06	59	40	16	30	25	M8	
		91 - 133	LC 08	109 - 150	MC 10							
		133 - 177	LC 13	150 - 192	MC 14							
		177 - 219	LC 17	190 - 231	MC 18							
		212 - 254	LC 20									
315	BB212	42 - 103	KK 33 (Bar Jaw)			49	50	21	30			1.5mm x 60°
		65 - 127	LE 05	97 - 160	ME 08	59	50	21	30	25	M8	
		120 - 183	LE 10	160 - 224	ME 14							
		183 - 250	LE 16	219 - 284	ME 20							
		250 - 316	LE 23	281 - 345	ME 26							
450	BB218	80 - 147	LH 05	100 - 167	MH 10	79	60	25.5	43	33	M8	1.5mm x 60°
		140 - 209	LH 10	160 - 229	MH 15							
		202 - 272	LH 15	222 - 292	MH 20							
		263 - 335	LH 20	285 - 356	MH 25							
		328 - 399	LH 25									
530	BB221	80 - 224	LH 05	100 - 243	MH 10	79	60	25.5	43	33	M8	1.5mm x 60°
		140 - 286	LH 10	160 - 306	MH 15							
		202 - 350	LH 15	222 - 370	MH 20							
		263 - 412	LH 20	285 - 433	MH 25							
		328 - 477	LH 25									

Adjustagrip Jaws are available on request in special sizes or to suit other chuck types.

Adjustagrip Hard Top Jaws

To suit Power Chucks
60° SERRATIONS

Material:

- Steel: 590M17

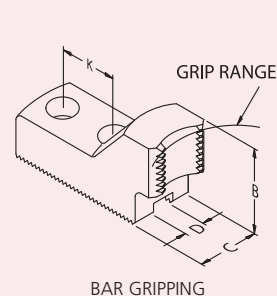
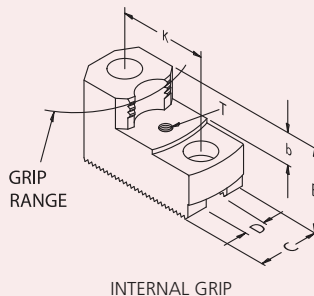
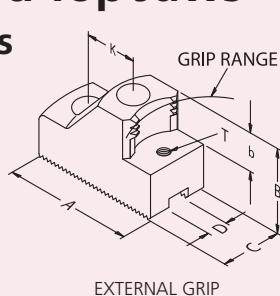

To suit • Kitagawa Chuck Series BS300

CHUCK Ø	TYPE	EXTERNAL GRIP RANGES	EXTERNAL GRIP JAW PART No	INTERNAL GRIP RANGES	INTERNAL GRIP JAW PART No	B	C	D	K	b	T	SERRATION
169	BS306	14 - 33	KK 16 (Bar Jaw)			39	35	12	20			1.5mm x 60°
		27 - 47	LA 03	47 - 69	MA 05	49	35	12	20	20	M6	
		45 - 67	LA 04	58 - 80	MA 06							
		59 - 81	LA 06	77 - 99	MA 07							
		73 - 96	LA 07	99 - 122	MA 09							
		90 - 112	LA 09									
210	BS308	21 - 47	KK 20 (Bar Jaw)			49	40	14	25			1.5mm x 60°
		43 - 71	LB 03	61 - 90	MB 06	49	40	14	25	20	M6	
		71 - 99	LB 06	90 - 122	MB 08							
		99 - 128	LB 09	122 - 151	MB 11							
		127 - 155	LB 12	151 - 181	MB 14							
254	BS310	29 - 70	KK 25 (Bar Jaw)			49	40	16	30			1.5mm x 60°
		48 - 89	LC 04	65 - 108	MC 06	59	40	16	30	25	M8	
		86 - 130	LC 08	104 - 148	MC 10							
		130 - 174	LC 13	145 - 190	MC 14							
		173 - 217	LC 17	185 - 229	MC 18							
		207 - 252	LC 20									
		247 - 289	LC 24									

Workpiece Height Pins



Adjustagrip Jaws are available on request in special sizes or to suit other chuck types.

Adjustagrip Hard Top Jaws

To suit Power Chucks
60° SERRATIONS

Material:

- Steel: 590M17

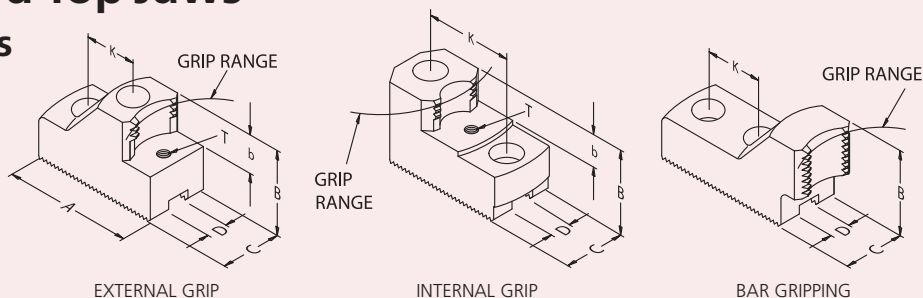

Serrated Hard Top Jaws

To suit • Kitagawa Chuck Series BL200

CHUCK Ø	TYPE	EXTERNAL GRIP RANGES	EXTERNAL GRIP JAW PART No	INTERNAL GRIP RANGES	INTERNAL GRIP JAW PART No	B	C	D	K	b	T	SERRATION
169	BL206	14 - 30	KK 16 (Bar Jaw)			39	35	12	20			1.5mm x 60°
		27 - 45	LA 03	46 - 66	MA 05	49	35	12	20	20	M6	
		42 - 64	LA 04	55 - 77	MA 06							
		56 - 78	LA 06	74 - 97	MA 07							
		70 - 93	LA 07	96 - 119	MA 09							
		86 - 109	LA 09									
215	BL208	24 - 52	KK 20 (Bar Jaw)			49	40	14	25			1.5mm x 60°
		46 - 76	LB 03	63 - 93	MB 06	49	40	14	25	20	M6	
		74 - 103	LB 06	93 - 125	MB 08							
		102 - 132	LB 09	125 - 156	MB 11							
		130 - 160	LB 12	155 - 186	MB 14							
254	BL210	27 - 70	KK 25 (Bar Jaw)			49	40	16	30			1.5mm x 60°
		47 - 89	LC 04	63 - 108	MC 06	59	40	16	30	25	M8	
		84 - 130	LC 08	102 - 148	MC 10							
		128 - 174	LC 13	143 - 190	MC 14							
		171 - 217	LC 17	183 - 229	MC 18							
		205 - 252	LC 20									
304	BL212	32 - 97	KK 33 (Bar Jaw)			49	50	21	30			1.5mm x 60°
		54 - 121	LE 05	85 - 154	ME 08	59	50	21	30	25	M8	
		109 - 177	LE 10	149 - 218	ME 14							
		172 - 242	LE 16	208 - 278	ME 20							
		239 - 310	LE 23	269 - 339	ME 26							

Adjustagrip Jaws are available on request in special sizes or to suit other chuck types.

Adjustagrip Hard Top Jaws

To suit Power Chucks
60° SERRATIONS

Material:

- Steel: 590M17

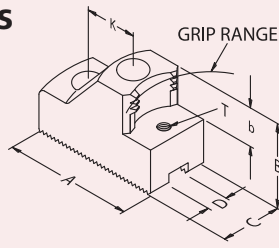

EXTERNAL GRIP

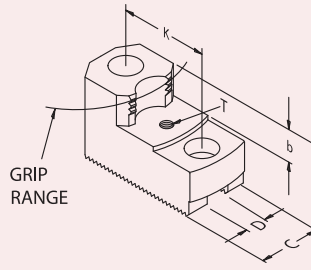

INTERNAL GRIP

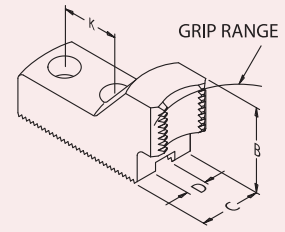

BAR GRIPPING

To suit • Kitagawa Chuck Series NL

CHUCK Ø	TYPE	EXTERNAL GRIP RANGES	EXTERNAL GRIP JAW PART No	INTERNAL GRIP RANGES	INTERNAL GRIP JAW PART No	B	C	D	K	b	T	SERRATION
165	NL06	16 - 32	KK 16 (Bar Jaw)			39	35	12	20			1.5mm x 60°
		30 - 46	LA 03	51 - 67	MA 05	49	35	12	20	20	M6	
		46 - 65	LA 04	62 - 80	MA 06							
		63 - 80	LA 06	80 - 101	MA 07							
		77 - 94	LA 07	101 - 121	MA 09							
		93 - 111	LA 09									
210	NL08	16 - 44	KK 20 (Bar Jaw)			49	40	14	25			1.5mm x 60°
		44 - 67	LB 03	61 - 89	MB 06	49	40	14	25	20	M6	
		72 - 98	LB 06	89 - 120	MB 08							
		97 - 125	LB 09	120 - 152	MB 11							
		125 - 151	LB 12	152 - 177	MB 14							
254	NL10	24 - 63	KK 25 (Bar Jaw)			49	40	16	30			1.5mm x 60°
		48 - 83	LC 04	59 - 102	MC 06	59	40	16	30	25	M8	
		80 - 123	LC 08	98 - 142	MC 10							
		123 - 167	LC 13	139 - 183	MC 14							
		166 - 211	LC 17	178 - 223	MC 18							
304	NL12	29 - 91	KK 32 (Bar Jaw)			49	50	18	30			1.5mm x 60°
		55 - 119	LD 05	84 - 150	MD 08	59	50	18	30	25	M8	
		112 - 179	LD 11	145 - 212	MD 14							
		176 - 244	LD 17	205 - 274	MD 20							
		239 - 307	LD 23									

Workpiece Height Pins



See page 165

Adjustagrip Jaws are available on request in special sizes or to suit other chuck types.

Adjustagrip Hard Top Jaws

To suit Power Chucks
60° SERRATIONS

Material:

- Steel: 590M17

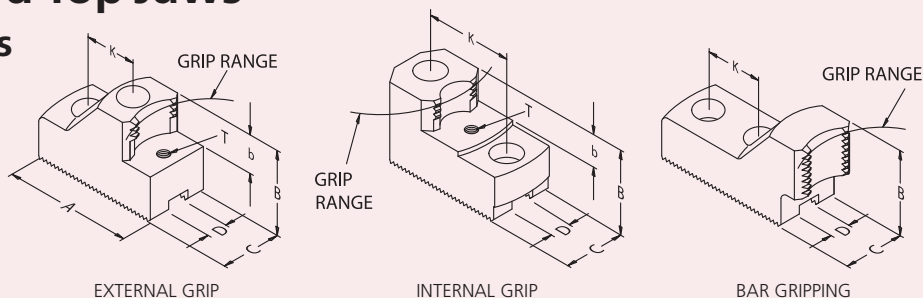

Serrated Hard Top Jaws

To suit • Matsumoto (MMK) Chuck Series ZA

CHUCK Ø	TYPE	EXTERNAL GRIP RANGES	EXTERNAL GRIP JAW PART No	INTERNAL GRIP RANGES	INTERNAL GRIP JAW PART No	B	C	D	K	b	T	SERRATION
210	ZA6-8-52	16 - 45	KK 20 (Bar Jaw)	51 - 85 79 - 115 111 - 148 141 - 178	MB 06 MB 08 MB 11 MB 14	49	40	14	25	20	M6	1.5mm x 60°
		32 - 68	LB 03									
		61 - 96	LB 06									
		88 - 125	LB 09									
		115 - 152	LB 12									
215	ZA6-8-66B	23 - 58	KK 20 (Bar Jaw)	63 - 99 92 - 129 125 - 162 154 - 192	MB 06 MB 08 MB 11 MB 14	49	40	14	25	20	M6	1.5mm x 60°
		45 - 82	LB 03									
		73 - 109	LB 06									
		102 - 139	LB 09									
		129 - 166	LB 12									
254	ZA8-10-66	25 - 63	KK 25 (Bar Jaw)	60 - 101 99 - 141 140 - 182 179 - 222	MC 06 MC 10 MC 14 MC 18	49	40	16	30	25	M8	1.5mm x 60°
		43 - 82	LC 04									
		81 - 123	LC 08									
		123 - 167	LC 13									
		167 - 210	LC 17									
254	ZA8-10-75	25 - 63	KK 25 (Bar Jaw)	60 - 101 99 - 141 140 - 182 179 - 222	MC 06 MC 10 MC 14 MC 18	49	40	16	30	25	M8	1.5mm x 60°
		43 - 82	LC 04									
		81 - 123	LC 08									
		123 - 166	LC 13									
		166 - 210	LC 17									
254	ZA8-10-80B	28 - 63	KK 25 (Bar Jaw)	64 - 103 103 - 144 144 - 183 183 - 223	MC 06 MC 10 MC 14 MC 18	49	40	16	30	25	M8	1.5mm x 60°
		48 - 85	LC 04									
		85 - 128	LC 08									
		128 - 171	LC 13									
		171 - 212	LC 17									
305	ZA8-12-85	33 - 64	KK 32 (Bar Jaw)	89 - 123 150 - 185 211 - 246 269 - 303	MD 08 MD 14 MD 20 MD 26	59	50	18	30	25	M8	1.5mm x 60°
		60 - 92	LD 05									
		118 - 151	LD 11									
		182 - 216	LD 17									
		245 - 279	LD 23									
305	ZA8-12-93B	41 - 73	KK 32 (Bar Jaw)	99 - 133 160 - 194 221 - 256 278 - 313	MD 08 MD 14 MD 20 MD 26	59	50	18	30	25	M8	1.5mm x 60°
		69 - 102	LD 05									
		127 - 161	LD 11									
		192 - 226	LD 17									
		255 - 289	LD 23									

Adjustagrip Jaws are available on request in special sizes or to suit other chuck types.

Adjustagrip Hard Top Jaws

To suit Power Chucks
60° SERRATIONS

Material:

- Steel: 590M17

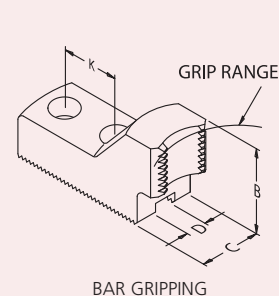
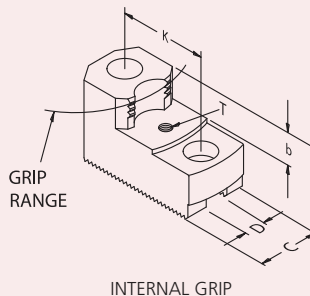
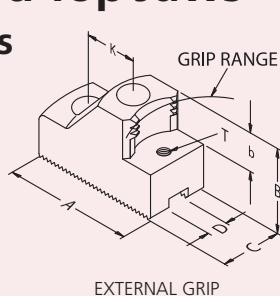

To suit • Matsumoto (MMK) Chuck Series H/HA

CHUCK Ø	TYPE	EXTERNAL GRIP RANGES	EXTERNAL GRIP JAW PART No	INTERNAL GRIP RANGES	INTERNAL GRIP JAW PART No	B	C	D	K	b	T	SERRATION
210	H-8	19 - 48	KK 20 (Bar Jaw)			49	40	14	25			1.5mm x 60°
	HA6-8	40 - 71	LB 03	58 - 88	MB 06	49	40	14	25	20	M6	
		69 - 99	LB 06	87 - 120	MB 08							
		97 - 128	LB 09	120 - 151	MB 11							
		124 - 155	LB 12	149 - 181	MB 14							
254	H-10	39 - 72	KK 25 (Bar Jaw)			49	40	16	30			1.5mm x 60°
	HA6-10	52 - 92	LC 04	68 - 111	MC 06	59	40	16	30	25	M8	
		89 - 133	LC 08	108 - 151	MC 10							
		133 - 176	LC 13	149 - 192	MC 14							
		176 - 220	LC 17	188 - 232	MC 18							
305	H-12	27 - 87	KK 32 (Bar Jaw)			59	50	18	30			1.5mm x 60°
	HA8-12	50 - 126	LD 05	79 - 157	MD 08	59	50	18	30	25	M8	
		107 - 186	LD 11	139 - 219	MD 14							
		170 - 251	LD 17	200 - 280	MD 20							
		233 - 314	LD 23									

Workpiece Height Pins



Adjustagrip Jaws are available on request in special sizes or to suit other chuck types.

Adjustagrip Hard Top Jaws

To suit Power Chucks
60° SERRATIONS

Material:

- Steel: 590M17

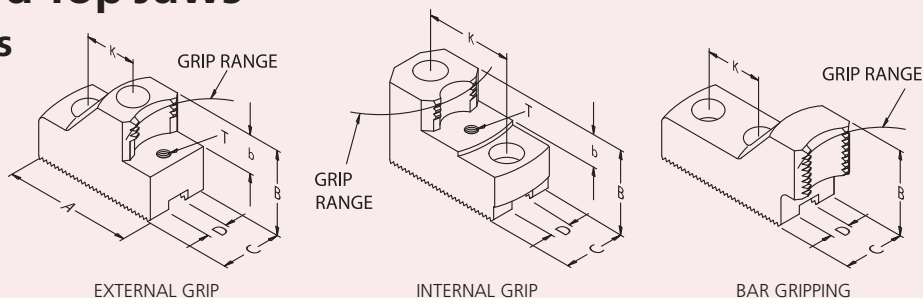

Serrated Hard Top Jaws

To suit • Matsumoto (LMC) Chuck Series PC

CHUCK Ø	TYPE	EXTERNAL GRIP RANGES	EXTERNAL GRIP JAW PART No	INTERNAL GRIP RANGES	INTERNAL GRIP JAW PART No	B	C	D	K	b	T	SERRATION
169	PC-6-46	20 - 36	KK 16 (Bar Jaw)			39	35	12	20			1.5mmx60°
		34 - 52	LA 03	56 - 71	MA 05	49	35	12	20	20	M6	
		52 - 70	LA 04	66 - 83	MA 06							
		68 - 84	LA 06	85 - 104	MA 07							
		82 - 98	LA 07	109 - 125	MA 09							
		98 - 115	LA 09									
210	PC-8-52	16 - 45	KK 20 (Bar Jaw)			49	40	14	25			1.5mm x 60°
		33 - 68	LB 03	51 - 85	MB 06	49	40	14	25	20	M6	
		61 - 96	LB 06	80 - 115	MB 08							
		88 - 125	LB 09	111 - 149	MB 11							
		115 - 152	LB 12	141 - 178	MB 14							
		149 - 186	LB 15									
254	PC-10-78	30 - 70	KK 25 (Bar Jaw)			49	40	16	30			1.5mm x 60°
		50 - 89	LC 04	66 - 108	MC 06	59	40	16	30	25	M8	
		87 - 129	LC 08	105 - 148	MC 10							
		130 - 173	LC 13	146 - 189	MC 14							
		173 - 217	LC 17	185 - 229	MC 18							
		209 - 253	LC 20									
304	PC-12-93	40 - 90	KK 32 (Bar Jaw)			49	50	18	30			1.5mm x 60°
		68 - 118	LD 05	98 - 150	MD 08	59	50	18	30	25	M8	
		126 - 178	LD 11	159 - 212	MD 14							
		190 - 243	LD 17	220 - 273	MD 20							
		253 - 307	LD 23	277 - 330	MD 26							
381	PC-15-120	46 - 109	LF 05	95 - 163	MF 10	79	60	22	43	33	M8	1.5mm x 60°
		95 - 163	LF 10	155 - 226	MF 16							
		155 - 225	LF 16	218 - 289	MF 22							
		216 - 287	LF 22	275 - 346	MF 28							
		275 - 346	LF 28	334 - 406	MF 34							
		334 - 406	LF 34									

Adjustagrip Jaws are available on request in special sizes or to suit other chuck types.

Adjustagrip Hard Top Jaws

To suit Power Chucks
60° SERRATIONS

Material:

- Steel: 590M17

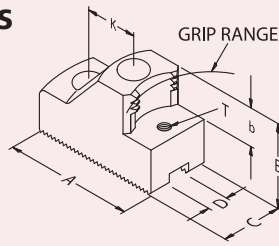

EXTERNAL GRIP

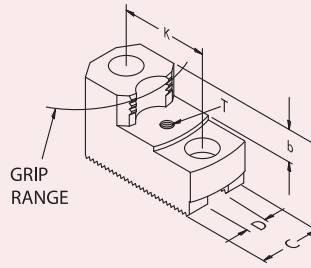

INTERNAL GRIP

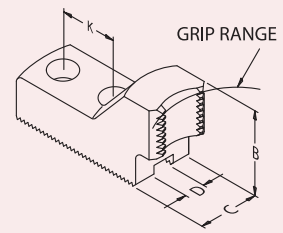

BAR GRIPPING

To suit • Pratt Burnerd Chuck Series International

CHUCK Ø	TYPE	EXTERNAL GRIP RANGES	EXTERNAL GRIP JAW PART No	INTERNAL GRIP RANGES	INTERNAL GRIP JAW PART No	B	C	D	K	b	T	SERRATION	
165	International 165	13 - 23	KK 16 (Bar Jaw)			39	35	12	20			1.5mmx60°	
		24 - 46	LA 03	45 - 67	MA 05	49	35	12	20	20	M6		
		41 - 65	LA 04	54 - 79	MA 06								
		55 - 80	LA 06	73 - 98	MA 07								
		69 - 94	LA 07	95 - 120	MA 09								
		85 - 111	LA 09										
210	International 210	48 - 74	KK 20 (Bar Jaw)			49	40	14	25			1.5mm x 60°	
		39 - 69	LB 03	57 - 86	MB 06	49	40	14	25	20	M6		
		68 - 97	LB 06	86 - 119	MB 08								
		96 - 126	LB 09	119 - 149	MB 11								
		123 - 153	LB 12	148 - 179	MB 14								
254	International 254	38 - 81	KK 25 (Bar Jaw)			49	40	16	30			1.5mm x 60°	
		43 - 84	LC 04	59 - 103	MC 06	59	40	16	30	25	M8		
		80 - 124	LC 08	98 - 143	MC 08								
		123 - 168	LC 13	139 - 184	MC 10								
		166 - 212	LC 17	178 - 224	MC 12								
305	International 305	34 - 90	KK 32 (Bar Jaw)			49	50	18	30			1.5mm x 60°	
		57 - 124	LD 05	86 - 155	MD 08	59	50	18	30	25	M8		
		114 - 184	LD 11	147 - 217	MD 14								
		178 - 249	LD 17	207 - 278	MD 20								
		241 - 312	LD 23										
380	International 380	59 - 117	LF 05	110 - 171	MF 10	79	60	22	43	33	M8	1.5mm x 60°	
		110 - 171	LF 10	171 - 234	MF 16								
		171 - 234	LF 16	234 - 297	MF 22								
		232 - 295	LF 22	291 - 354	MF 28								
		291 - 354	LF 28										
		350 - 414	LF 34										

Adjustagrip Hard Top Jaws

To suit Power Chucks
60° SERRATIONS

Material:

- Steel: 590M17

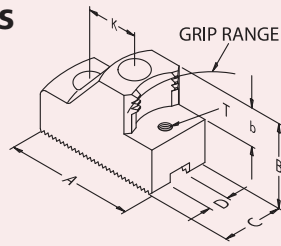

EXTERNAL GRIP

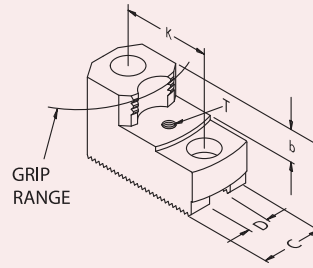

INTERNAL GRIP

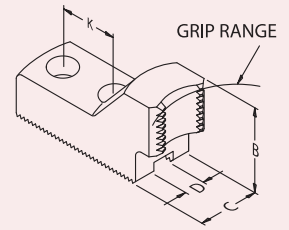

BAR GRIPPING

Serrated Hard Top Jaws

To suit • Pratt Burnerd Chuck Series International Setrite

CHUCK Ø	TYPE	EXTERNAL GRIP RANGES	EXTERNAL GRIP JAW PART No	INTERNAL GRIP RANGES	INTERNAL GRIP JAW PART No	B	C	D	K	b	T	SERRATION
170	9829-17010	16 - 35	KK 16 (Bar Jaw)			39	35	12	20			1.5mm x 60°
	9827- 18100	30 - 50	LA 03	50 - 71	MA 05	49	35	12	20	20	M6	
		49 - 69	LA 04	61 - 82	MA 06							
		63 - 83	LA 06	80 - 102	MA 07							
		77 - 98	LA 07	103 - 124	MA 09							
		94 - 114	LA 09									
210	9821-32223	29 - 44	KK 20 (Bar Jaw)			49	40	14	25			1.5mm x 60°
	9827-22000	51 - 70	LB 03	69 - 87	MB 06	49	40	14	25	20	M6	
		79 - 99	LB 06	98 - 118	MB 08							
		107 - 128	LB 09	131 - 151	MB 11							
		134 - 154	LB 12	160 - 180	MB 14							
265	9821-42723	32 - 74	KK 25 (Bar Jaw)			49	40	16	30			1.5mm x 60°
	9827-27010	52 - 93	LC 04	69 - 112	MC 06	59	40	16	30	25	M8	
		90 - 133	LC 08	108 - 152	MC 08							
		133 - 178	LC 13	149 - 194	MC 10							
		177 - 221	LC 17	189 - 233	MC 12							

Workpiece Height Pins

See page 165



Adjustagrip Hard Top Jaws

To suit Power Chucks
60° SERRATIONS

Material:

- Steel: 590M17

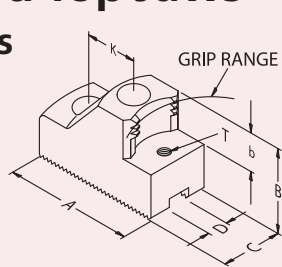

EXTERNAL GRIP

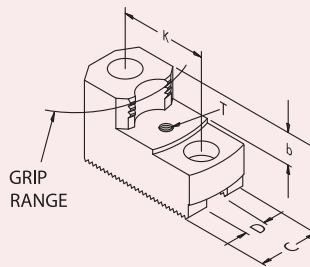

INTERNAL GRIP

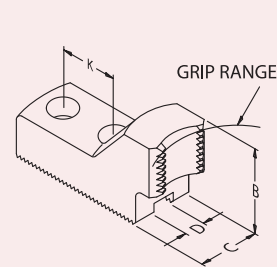

BAR GRIPPING

To suit • Pratt Burnerd Chuck Series Constant Grip/HSQC

CHUCK Ø	TYPE	EXTERNAL GRIP RANGES	EXTERNAL GRIP JAW PART No	INTERNAL GRIP RANGES	INTERNAL GRIP JAW PART No	B	C	D	K	b	T	SERRATION
165	9151-21723	14 - 32	KK 16 (Bar Jaw)			39	35	12	20			1.5mm x 60°
	9151-31723	27 - 46	LA 03			49	35	12	20	20	M6	
	9151-41723	31 - 65	LA 04	47 - 79	MA 06							
	9131-21723	50 - 79	LA 06	67 - 98	MA 07							
	9131-31723	64 - 94	LA 07	82 - 120	MA 09							
	9131-41723	73 - 111	LA 09									
210	9151-32123	16 - 45	KK 20 (Bar Jaw)			49	40	14	25			1.5mm x 60°
	9151-42123	26 - 68	LB 03	51 - 85	MB 06	49	40	14	25	20	M6	
	9151-52123	54 - 96	LB 06	72 - 115	MB 08							
	9131-32123	81 - 125	LB 09	104 - 148	MB 11							
	9131-42123	107 - 152	LB 12	133 - 178	MB 14							
	9131-52123											
254	9151-42623	23 - 64	KK 25 (Bar Jaw)			49	40	16	30			1.5mm x 60°
	9151-52623	39 - 84	LC 04	54 - 102	MC 06	59	40	16	30	25	M8	
	9131-42623	68 - 124	LC 08	85 - 142	MC 08							
	9131-52623	110 - 168	LC 13	126 - 184	MC 10							
		153 - 211	LC 17	165 - 223	MC 12							
305	9151-53123	27 - 95	KK 32 (Bar Jaw)			49	50	18	30			1.5mm x 60°
	9151-63123	44 - 124	LD 05	75 - 154	MD 08	59	50	18	30	25	M8	
	9131-53123	90 - 184	LD 11	122 - 217	MD 14							
	9131-63123	153 - 249	LD 17	182 - 278	MD 20							
		215 - 312	LD 23	239 - 335	MD 26							
380	9151-53823	47 - 109	LF 05	96 - 163	MF 10	79	60	22	43	33	M8	1.5mm x 60°
	9151-63823	82 - 163	LF 10	139 - 226	MF 16							
	9131-53823	139 - 226	LF 16	201 - 289	MF 22							
	9131-63823	199 - 287	LF 22	258 - 346	MF 28							
		258 - 346	LF 28	317 - 406	MF 34							
		317 - 406	LF 34									

Adjustagrip Jaws are available on request in special sizes or to suit other chuck types.

Adjustagrip Hard Top Jaws

To suit Power Chucks
60° SERRATIONS

Material:

- Steel: 590M17

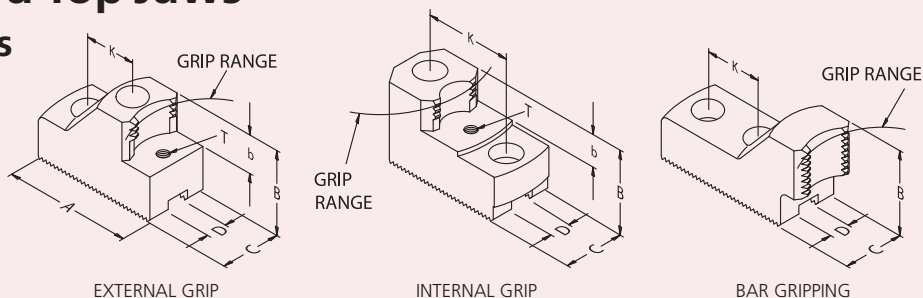

Serrated Hard Top Jaws

To suit • Samchully Chuck Series HS

CHUCK Ø	TYPE	EXTERNAL GRIP RANGES	EXTERNAL GRIP JAW PART No	INTERNAL GRIP RANGES	INTERNAL GRIP JAW PART No	B	C	D	K	b	T	SERRATION
169	HS06	14 - 29	KK 16 (Bar Jaw)			39	35	12	20			1.5mm x 60°
		27 - 44	LA 03	45 - 65	MA 05	49	35	12	20	20	M6	
		40 - 63	LA 04	52 - 76	MA 06							
		54 - 77	LA 06	70 - 96	MA 07							
		68 - 92	LA 07	93 - 118	MA 09							
		84 - 108	LA 09									
210	HS08	18 - 44	KK 20 (Bar Jaw)			49	40	14	25			1.5mm x 60°
		39 - 68	LB 03	56 - 85	MB 06	49	40	14	25	20	M6	
		68 - 96	LB 06	85 - 118	MB 08							
		96 - 124	LB 09	118 - 148	MB 11							
		123 - 151	LB 12	147 - 177	MB 14							
254	HS10	29 - 64	KK 25 (Bar Jaw)			49	40	16	30			1.5mm x 60°
		48 - 85	LC 04	64 - 103	MC 06	59	40	16	30	25	M8	
		85 - 129	LC 08	103 - 144	MC 10							
		129 - 172	LC 13	144 - 184	MC 14							
		172 - 211	LC 17	184 - 224	MC 18							
304	HS12	33 - 87	KK 33 (Bar Jaw)			49	50	21	30			1.5mm x 60°
		55 - 111	LE 05	85 - 149	ME 08	59	50	21	30	25	M8	
		110 - 172	LE 10	149 - 208	ME 14							
		172 - 239	LE 16	207 - 269	ME 20							
		239 - 299	LE 23	269 - 330	ME 26							

Adjustagrip Jaws are available on request in special sizes or to suit other chuck types.

Adjustagrip Hard Top Jaws

To suit Power Chucks
60° SERRATIONS

Material:

- Steel: 590M17

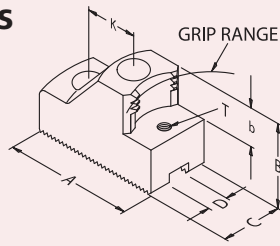

EXTERNAL GRIP

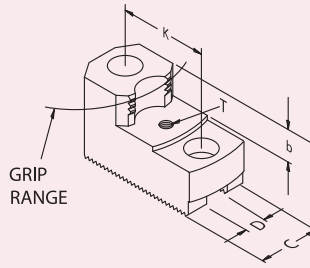

INTERNAL GRIP

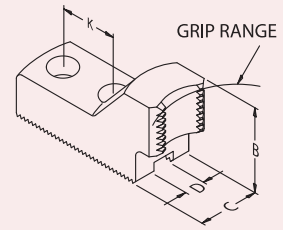

BAR GRIPPING

To suit • Samchully Chuck Series HH & MH

CHUCK Ø	TYPE	EXTERNAL GRIP RANGES	EXTERNAL GRIP JAW PART No	INTERNAL GRIP RANGES	INTERNAL GRIP JAW PART No	B	C	D	K	b	T	SERRATION	
175	HH206	19 - 40	KK 16 (Bar Jaw)			39	35	12	20			1.5mm x 60°	
	MH206	33 - 55	LA 03	54 - 75	MA 05	49	35	12	20	20	M6		
		52 - 74	LA 04	65 - 86	MA 06								
		66 - 89	LA 06	84 - 106	MA 07								
		81 - 103	LA 07	107 - 128	MA 09								
		97 - 119	LA 09										
210	HH208	25 - 46	KK 20 (Bar Jaw)			49	40	14	25			1.5mm x 60°	
	MH208	47 - 74	LB 03	64 - 93	MB 06	49	40	14	25	20	M6		
		74 - 103	LB 06	93 - 123	MB 08								
		103 - 130	LB 09	126 - 155	MB 11								
		130 - 154	LB 12	155 - 179	MB 14								
254	HH210	34 - 67	KK 25 (Bar Jaw)			49	40	16	30			1.5mm x 60°	
	MH210	54 - 90	LC 04	71 - 108	MC 06	59	40	16	30	25	M8		
		90 - 127	LC 08	108 - 149	MC 10								
		115 - 149	LC 10	149 - 190	MC 14								
		130 - 171	LC 13	190 - 226	MC 18								
		155 - 191	LC 15										
		179 - 215	LC 17										
315	HH212	43 - 98	KK 33 (Bar Jaw)			49	50	21	30			1.5mm x 60°	
	MH212	66 - 122	LE 05	97 - 160	ME 08	59	50	21	30	25	M8		
		121 - 184	LE 10	160 - 219	ME 14								
		184 - 251	LE 16	219 - 281	ME 20								
		251 - 310	LE 23	281 - 340	ME 26								

Workpiece Height Pins

See page 165



Adjustagrip Jaws are available on request in special sizes or to suit other chuck types.

Adjustagrip Hard Top Jaws

To suit Power Chucks
60° SERRATIONS

Material:

- Steel: 590M17

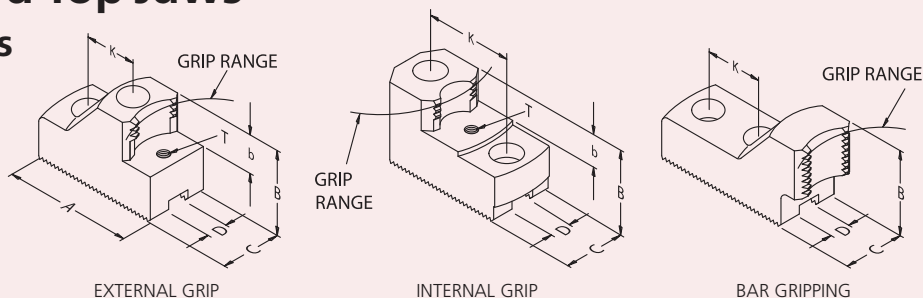

Serrated Hard Top Jaws

To suit • Samchully Chuck Series HCH

CHUCK Ø	TYPE	EXTERNAL GRIP RANGES	EXTERNAL GRIP JAW PART No	INTERNAL GRIP RANGES	INTERNAL GRIP JAW PART No	B	C	D	K	b	T	SERRATION
165	HCH-06	14 - 28	KK 16 (Bar Jaw)	46 - 63 47 - 74 68 - 94 88 - 116	MA 05 MA 06 MA 07 MA 09	39	35	12	20	20	M6	1.5mm x 60°
		27 - 42	LA 03			49	35	12	20			
		35 - 61	LA 04									
		50 - 75	LA 06									
		64 - 90	LA 07									
		78 - 106	LA 09									
210	HCH-08	16 - 41	KK 20 (Bar Jaw)	51 - 81 78 - 111 110 - 144 140 - 174	MB 06 MB 08 MB 11 MB 14	49	40	14	25	20	M6	1.5mm x 60°
		31 - 64	LB 03			49	40	14	25			
		60 - 92	LB 06									
		87 - 121	LB 09									
254	HCH-10	25 - 58	KK 25 (Bar Jaw)	61 - 97 100 - 136 140 - 178 180 - 217	MC 06 MC 10 MC 14 MC 18	49	40	16	30	25	M8	1.5mm x 60°
		44 - 81	LC 04			59	40	16	30			
		81 - 123	LC 08									
		123 - 166	LC 13									
		166 - 206	LC 17									
		203 - 245	LC 20									
304	HCH-12	27 - 86	KK 32 (Bar Jaw)	77 - 145 138 - 207 198 - 268 254 - 326	MD 08 MD 14 MD 20 MD 26	49	50	18	30	25	M8	1.5mm x 60°
		49 - 114	LD 05			59	50	18	30			
		105 - 173	LD 11									
		169 - 238	LD 17									
381	HCH-15	57 - 107	LF 05	108 - 166 166 - 233 230 - 298 287 - 344 344 - 400	MF 10 MF 16 MF 22 MF 28 MF 34	79	60	22	43	33	M8	1.5mm x 60°
		107 - 170	LF 10									
		167 - 233	LF 16									
		228 - 295	LF 22									
		287 - 354	LF 28									
		346 - 400	LF 34									
450	HCH-18	57 - 168	LF 05	108 - 223 169 - 286 232 - 349 289 - 407 348 - 467	MF 10 MF 16 MF 22 MF 28 MF 34	79	60	22	43	33	M8	1.5mm x 60°
		108 - 223	LF 10									
		169 - 286	LF 16									
		230 - 347	LF 22									
		289 - 407	LF 28									
		348 - 467	LF 34									

Adjustagrip Jaws are available on request in special sizes or to suit other chuck types.

Adjustagrip Hard Top Jaws

To suit Power Chucks
60° SERRATIONS

Material:

- Steel: 590M17

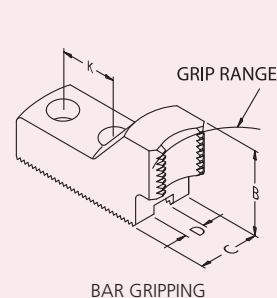
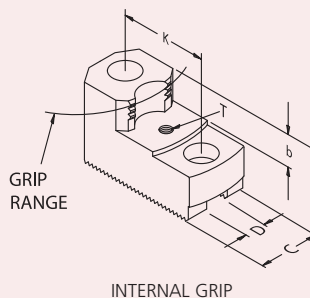
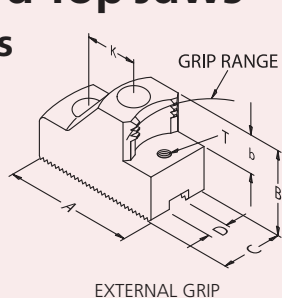

To suit • Schunk Chuck Series HSL

CHUCK Ø	TYPE	EXTERNAL GRIP RANGES	EXTERNAL GRIP JAW PART No	INTERNAL GRIP RANGES	INTERNAL GRIP JAW PART No	B	C	D	K	b	T	SERRATION
165	HSL 165	20 - 45	KK 16 (Bar Jaw)			39	35	12	20			1.5mm x 60°
		34 - 59	LA 03	55 - 80	MA 05	49	35	12	20	20	M6	
		53 - 78	LA 04	66 - 92	MA 06							
		67 - 93	LA 06	85 - 111	MA 07							
		81 - 108	LA 07	107 - 134	MA 09							
		98 - 124	LA 09									
210	HSL 210	24 - 63	KK 20 (Bar Jaw)			49	40	14	25			1.5mm x 60°
		47 - 87	LB 03	64 - 103	MB 06	49	40	14	25	20	M6	
		75 - 114	LB 06	94 - 133	MB 08							
		103 - 143	LB 09	127 - 167	MB 11							
		130 - 171	LB 12	156 - 197	MB 14							
250	HSL 250	29 - 79	KK 25 (Bar Jaw)			49	40	16	30			1.5mm x 60°
		49 - 98	LC 04	66 - 117	MC 06	59	40	16	30	25	M8	
		87 - 138	LC 08	105 - 157	MC 08							
		131 - 183	LC 13	146 - 198	MC 10							
		174 - 226	LC 17	186 - 238	MC 12							
315	HSL 315	39 - 110	KK 32 (Bar Jaw)			49	50	18	30			1.5mm x 60°
		67 - 138	LD 05	97 - 170	MD 08	59	50	18	30	25	M8	
		125 - 198	LD 11	158 - 232	MD 14							
		189 - 263	LD 17	219 - 293	MD 20							
		252 - 327	LD 23									
400	HSL 400	73 - 173	LF 05	125 - 228	MF 10	79	60	22	43	33	M8	1.5mm x 60°
		125 - 227	LF 10	187 - 291	MF 16							
		187 - 291	LF 16	250 - 354	MF 22							
		248 - 352	LF 22	307 - 412	MF 28							
		307 - 412	LF 28	367 - 472	MF 34							
		367 - 471	LF 34									

Adjustagrip Jaws are available on request in special sizes or to suit other chuck types.

Adjustagrip Hard Top Jaws

To suit Power Chucks
60° SERRATIONS

Material:

- Steel: 590M17

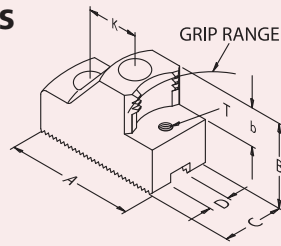

EXTERNAL GRIP

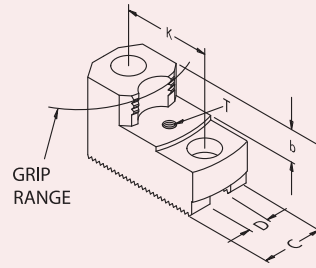

INTERNAL GRIP

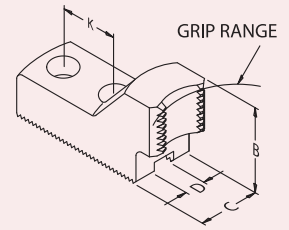

BAR GRIPPING

Serrated Hard Top Jaws

To suit • Schunk Chuck Series Rota NCK

CHUCK Ø	TYPE	EXTERNAL GRIP RANGES	EXTERNAL GRIP JAW PART No	INTERNAL GRIP RANGES	INTERNAL GRIP JAW PART No	B	C	D	K	b	T	SERRATION
169	ROTA	14 - 30	KK 16 (Bar Jaw)	46 - 66	MA 05	39	35	12	20			1.5mm x 60°
	NCK 165	26 - 45	LA 03	53 - 77	MA 06	49	35	12	20	20	M6	
		40 - 64	LA 04	71 - 97	MA 07							
		53 - 78	LA 06	94 - 119	MA 09							
		68 - 93	LA 07									
84 - 109	LA 09											
210	ROTA	18 - 44	KK 20 (Bar Jaw)			49	40	14	25			1.5mm x 60°
	NCK 210	39 - 67	LB 03	57 - 86	MB 06	49	40	14	25	20	M6	
		67 - 96	LB 06	86 - 118	MB 08							
		96 - 124	LB 09	118 - 148	MB 11							
123 - 152	LB 12	148 - 178	MB 14									
254	ROTA	29 - 63	KK 25 (Bar Jaw)			49	40	16	30			1.5mm x 60°
	NCK 250	48 - 55	LC 04	65 - 104	MC 06	59	40	16	30	25	M8	
		85 - 129	LC 08	104 - 144	MC 08							
		129 - 172	LC 13	144 - 184	MC 10							
172 - 212	LC 17	184 - 223	MC 12									
304	ROTA	33 - 86	KK 33 (Bar Jaw)			49	50	21	30			1.5mm x 60°
	NCK 315	55 - 110	LE 05	86 - 149	ME 08	59	50	21	30	25	M8	
		109 - 172	LE 10	149 - 208	ME 14							
		172 - 239	LE 16	208 - 269	ME 20							
239 - 300												

Workpiece Height Pins

See page 165



Adjustagrip Jaws are available on request in special sizes or to suit other chuck types.

Adjustagrip Hard Top Jaws

To suit Power Chucks
60° SERRATIONS

Material:

- Steel: 590M17

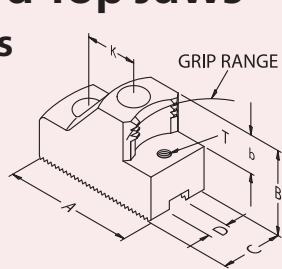

EXTERNAL GRIP

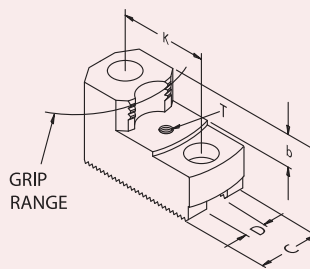

INTERNAL GRIP

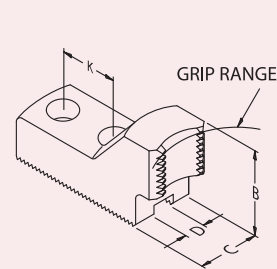

BAR GRIPPING

To suit • Schunk Chuck Series Rota NC/NCF

CHUCK Ø	TYPE	EXTERNAL GRIP RANGES	EXTERNAL GRIP JAW PART No	INTERNAL GRIP RANGES	INTERNAL GRIP JAW PART No	B	C	D	K	b	T	SERRATION	
165	ROTA	14 - 40	KK 16 (Bar Jaw)			39	35	12	20			1.5mm x 60°	
	NC/NCF	27 - 54	LA 03	45 - 74	MA 06	49	35	12	20	20	M6		
	165		44 - 73	LA 04	55 - 86	MA 07							
			57 - 88	LA 06	74 - 105	MA 09							
			71 - 102	LA 07	96 - 128								
		88 - 119	LA 09										
210	ROTA	16 - 57	KK 20 (Bar Jaw)			49	40	14	25			1.5mm x 60°	
	NC/NCF	26 - 81	LB 03	50 - 97	MB 06	49	40	14	25	20	M6		
	210		51 - 109	LB 06	68 - 127	MB 08							
			77 - 138	LB 09	99 - 160	MB 11							
		104 - 165	LB 12	128 - 190	MB 14								
254	ROTA	28 - 80	KK 25 (Bar Jaw)			49	40	16	30			1.5mm x 60°	
	NC/NCF	47 - 99	LC 04	63 - 117	MC 06	59	40	16	30	25	M8		
	250		85 - 139	LC 08	102 - 157	MC 08							
			129 - 184	LC 13	143 - 199	MC 10							
		172 - 227	LC 17	183 - 238	MC 12								
315	ROTA	34 - 118	KK 32 (Bar Jaw)			49	50	18	30			1.5mm x 60°	
	NC/NCF	61 - 146	LD 05	90 - 177	MD 08	59	50	18	30	25	M8		
	315		119 - 206	LD 11	151 - 239	MD 14							
			183 - 271	LD 17	211 - 301	MD 20							
		246 - 334	LD 23	269 - 358	MD 26								
400	ROTA	63 - 152	LF 05	114 - 206	MF 10	79	60	22	43	33	M8	1.5mm x 60°	
	NC/NCF	115 - 206	LF 10	176 - 269	MF 16								
	400		176 - 269	LF 16	238 - 332	MF 22							
			237 - 330	LF 22	295 - 390	MF 28							
			296 - 390	LF 28	355 - 449	MF 34							
		355 - 450	LF 34										

Adjustagrip Jaws are available on request in special sizes or to suit other chuck types.

Adjustagrip Hard Top Jaws

To suit Power Chucks
60° SERRATIONS

Material:

- Steel: 590M17

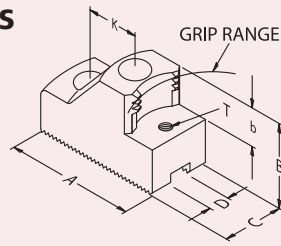

EXTERNAL GRIP

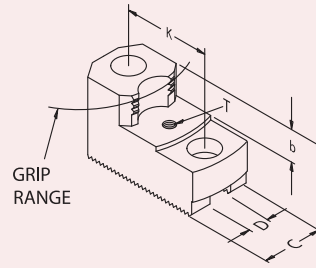

INTERNAL GRIP

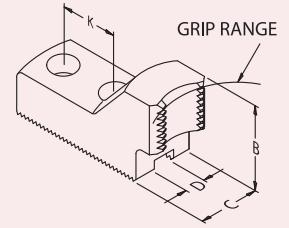

BAR GRIPPING

Serrated Hard Top Jaws

To suit • Schunk Chuck Series Rota-NCK plus

CHUCK Ø	TYPE	EXTERNAL GRIP RANGES	EXTERNAL GRIP JAW PART No	INTERNAL GRIP RANGES	INTERNAL GRIP JAW PART No	B	C	D	K	b	T	SERRATION
169	ROTA NCK	14 - 43	KK 16 (Bar Jaw)			39	35	12	20			1.5mm x 60°
	plus 165	27 - 57	LA 03	46 - 78	MA 05	49	35	12	20	20	M6	
		40 - 76	LA 04	53 - 90	MA 06							
		53 - 91	LA 06	71 - 109	MA 07							
		67 - 105	LA 07	94 - 132	MA 09							
		84 - 122	LA 09									
210	ROTA NCK	16 - 52	KK 20 (Bar Jaw)			49	40	14	25			1.5mm x 60°
	plus 210	32 - 76	LB 03	51 - 93	MB 06	49	40	14	25	20	M6	
		61 - 103	LB 06	79 - 123	MB 08							
		89 - 132	LB 09	112 - 156	MB 11							
		116 - 160	LB 12	141 - 186	MB 14							
254	ROTA NCK	25 - 75	KK 25 (Bar Jaw)			49	40	16	30			1.5mm x 60°
	plus 250	44 - 95	LC 04	60 - 113	MC 06	59	40	16	30	25	M8	
		81 - 135	LC 08	99 - 153	MC 08							
		124 - 179	LC 13	140 - 195	MC 14							
		167 - 223	LC 17	179 - 235	MC 18							
		202 - 257	LC 20									
304	ROTA NCK	31 - 97	KK 32 (Bar Jaw)			49	50	21	30			1.5mm x 60°
	plus 315	52 - 121	LE 05	83 - 154	ME 08	59	50	21	30	25	M8	
		107 - 177	LE 10	147 - 219	ME 14							
		170 - 242	LE 16	205 - 278	ME 20							
		237 - 310	LE 23	267 - 340	ME 26							

Workpiece Height Pins



Adjustagrip Jaws are available on request in special sizes or to suit other chuck types.

Adjustagrip Hard Top Jaws

To suit Power Chucks
60° SERRATIONS

Material:

- Steel: 590M17

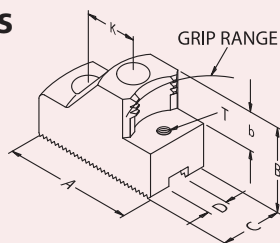

EXTERNAL GRIP

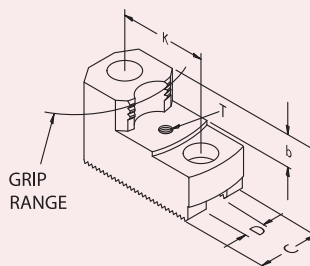

INTERNAL GRIP

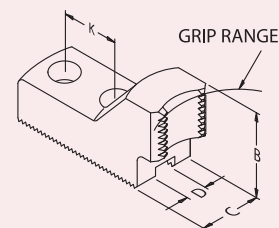

BAR GRIPPING

To suit • Seoam Ace Chuck Series CAH

CHUCK Ø	TYPE	EXTERNAL GRIP RANGES	EXTERNAL GRIP JAW PART No	INTERNAL GRIP RANGES	INTERNAL GRIP JAW PART No	B	C	D	K	b	T	SERRATION
169	CAH-06	14 - 33	KK 16 (Bar Jaw)			39	35	12	20			1.5mm x 60°
		27 - 48	LA 03	48 - 69	MA 05	49	35	12	20	20	M6	
		46 - 67	LA 04	59 - 80	MA 06							
		60 - 81	LA 06	78 - 100	MA 07							
		74 - 96	LA 07	100 - 122	MA 09							
210	CAH-08	16 - 44	KK 20 (Bar Jaw)			49	40	14	25			1.5mm x 60°
		36 - 68	LB 03	54 - 85	MB 06	49	40	14	25	20	M6	
		65 - 95	LB 06	83 - 115	MB 08							
		92 - 124	LB 09	115 - 148	MB 11							
		119 - 152	LB 12	145 - 177	MB 14							
254	CAH-10	31 - 65	KK 25 (Bar Jaw)			49	40	16	30			1.5mm x 60°
		51 - 84	LC 04	68 - 103	MC 06	59	40	16	30	25	M8	
		89 - 124	LC 08	107 - 143	MC 10							
		132 - 169	LC 13	148 - 184	MC 14							
		176 - 212	LC 17	187 - 224	MC 18							
304	CAH-12	37 - 91	KK 32 (Bar Jaw)			49	50	18	30			1.5mm x 60°
		59 - 115	LE 05	91 - 148	ME 08	59	50	18	30	25	M8	
		114 - 171	LE 10	154 - 212	ME 14							
		178 - 236	LE 16	213 - 272	ME 20							
		245 - 303	LE 23	275 - 333	ME 26							
381	CAH-15	57 - 107	LF 05	109 - 167	MF 10	79	60	22	43	33	M8	1.5mm x 60°
		107 - 167	LF 10	167 - 230	MF 16							
		167 - 228	LF 16	230 - 287	MF 22							
		228 - 287	LF 22	287 - 347	MF 28							
		287 - 347	LF 28	347 - 398	MF 34							
450	CAH-18	57 - 159	LF 05	109 - 214	MF 10	79	60	22	43	33	M8	1.5mm x 60°
		108 - 214	LF 10	169 - 277	MF 16							
		169 - 277	LF 16	232 - 340	MF 22							
		230 - 338	LF 22	289 - 398	MF 28							
		289 - 398	LF 28	348 - 458	MF 34							
348 - 458	LF 34											

Adjustagrip Jaws are available on request in special sizes or to suit other chuck types.

Adjustagrip Hard Top Jaws

To suit Power Chucks
60° SERRATIONS

Material:

- Steel: 590M17

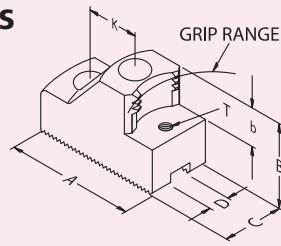

EXTERNAL GRIP

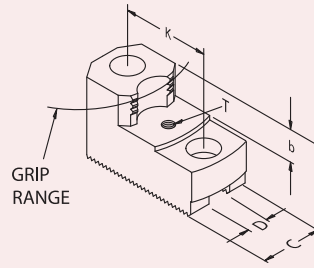

INTERNAL GRIP

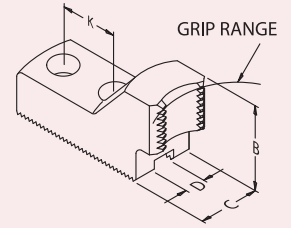

BAR GRIPPING

Serrated Hard Top Jaws

To suit • Seoam Ace Chuck Series CGH

CHUCK Ø	TYPE	EXTERNAL GRIP RANGES	EXTERNAL GRIP JAW PART No	INTERNAL GRIP RANGES	INTERNAL GRIP JAW PART No	B	C	D	K	b	T	SERRATION
169	CGH-06	18 - 34	KK 16 (Bar Jaw)			39	35	12	20			1.5mm x 60°
		32 - 50	LA 03	53 - 70	MA 05	49	35	12	20	20	M6	
		50 - 68	LA 04	64 - 83	MA 06							
		65 - 82	LA 06	83 - 104	MA 07							
		79 - 97	LA 07	104 - 123	MA 09							
		96 - 113	LA 09									
210	CGH-08	28 - 46	KK 20 (Bar Jaw)			49	40	14	25			1.5mm x 60°
		51 - 72	LB 03	68 - 88	MB 06	49	40	14	25	20	M6	
		78 - 100	LB 06	97 - 120	MB 08							
		106 - 130	LB 09	129 - 153	MB 11							
		133 - 154	LB 12	158 - 180	MB 14							
254	CGH-10	32 - 66	KK 25 (Bar Jaw)			49	40	16	30			1.5mm x 60°
		52 - 89	LC 04	69 - 107	MC 06	59	50	21	30	25	M8	
		89 - 132	LC 08	107 - 148	MC 10							
		132 - 175	LC 13	148 - 188	MC 14							
		175 - 214	LC 17	188 - 226	MC 18							

Workpiece Height Pins

See page 165



Adjustagrip Jaws are available on request in special sizes or to suit other chuck types.

Adjustagrip Hard Top Jaws

To suit Power Chucks
60° SERRATIONS

Material:

- Steel: 590M17

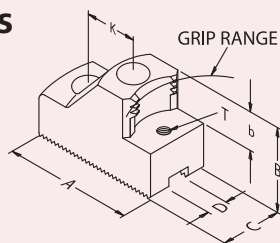

EXTERNAL GRIP

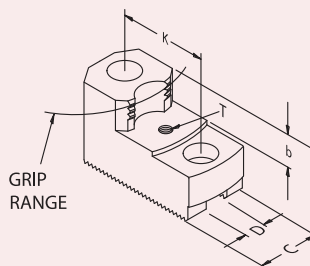

INTERNAL GRIP

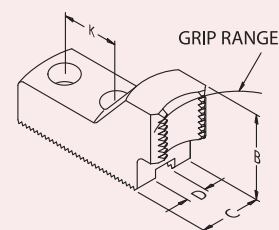

BAR GRIPPING

To suit • SMW-Autoblok Chuck Series BB-M

CHUCK Ø	TYPE	EXTERNAL GRIP RANGES	EXTERNAL GRIP JAW PART No	INTERNAL GRIP RANGES	INTERNAL GRIP JAW PART No	B	C	D	K	b	T	SERRATION
175	BB-M175	18 - 50	KK 16 (Bar Jaw)			39	35	12	20			1.5mm x 60°
		33 - 64	LA 03	54 - 85	MA 05	49	40	12	20	20	M6	
		52 - 83	LA 04	65 - 97	MA 06							
		66 - 98	LA 06	84 - 116	MA 07							
		80 - 112	LA 07	104 - 139	MA 09							
210	BB-M210	23 - 52	KK 20 (Bar Jaw)			49	40	14	25			1.5mm x 60°
		46 - 76	LB 03	63 - 93	MB 06	49	40	14	25	20	M6	
		74 - 103	LB 06	93 - 123	MB 08							
		102 - 132	LB 09	126 - 155	MB 11							
		130 - 160	LB 12	155 - 186	MB 14							
254	BB-M250	38 - 63	KK 25 (Bar Jaw)			49	40	16	30			1.5mm x 60°
		58 - 83	LC 04	75 - 101	MC 06	59	40	16	30	25	M8	
		78 - 103	LC 06	95 - 121	MC 08							
		97 - 123	LC 08	115 - 141	MC 10							
		117 - 143	LC 10	135 - 161	MC 12							
		140 - 167	LC 13	155 - 183	MC 14							
		160 - 187	LC 15	175 - 201	MC 16							
184 - 210	LC 17	196 - 222	MC 18									
315	BB-M315	65 - 101	KK 33 (Bar Jaw)			49	50	21	30			1.5mm x 60°
		89 - 125	LE 05	122 - 158	ME 08	59	50	21	30	25	M8	
		117 - 153	LE 07	154 - 190	ME 10							
		145 - 181	LE 10	186 - 222	ME 14							
		175 - 211	LE 13	215 - 251	ME 18							
		210 - 246	LE16	245 - 282	ME 20							
		243 - 279	LE 20	275 - 312	ME 24							
277 - 314	LE 23											

Adjustagrip Jaws are available on request in special sizes or to suit other chuck types.

Adjustagrip Hard Top Jaws

To suit Power Chucks
60° SERRATIONS

Material:

- Steel: 590M17

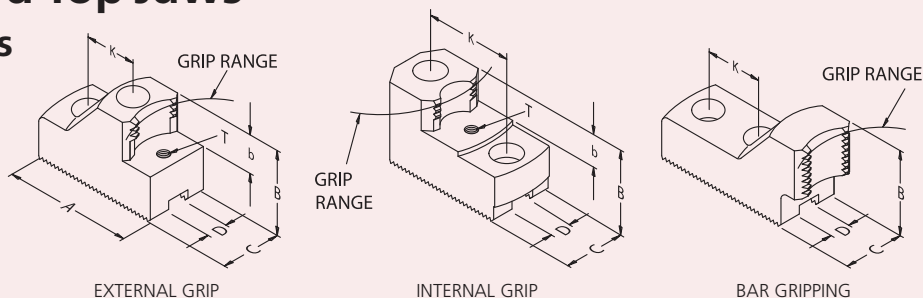

Serrated Hard Top Jaws

To suit • SMW-Autoblok Chuck Series BH-M

CHUCK Ø	TYPE	EXTERNAL GRIP RANGES	EXTERNAL GRIP JAW PART No	INTERNAL GRIP RANGES	INTERNAL GRIP JAW PART No	B	C	D	K	b	T	SERRATION
165	BH-M165	13 - 38	KK 16 (Bar Jaw)			39	35	12	20			1.5mm x 60°
		27 - 52	LA 03	46 - 73	MA 05	49	40	12	20	20	M6	
		41 - 71	LA 04	54 - 85	MA 06							
		55 - 86	LA 06	72 - 104	MA 07							
		69 - 101	LA 07	95 - 127	MA 09							
		85 - 117	LA 09									
210	BH-M210	16 - 51	KK 20 (Bar Jaw)			49	40	14	25			1.5mm x 60°
		32 - 75	LB 03	51 - 92	MB 06	49	40	14	25	20	M6	
		60 - 102	LB 06	79 - 122	MB 08							
		88 - 132	LB 09	111 - 155	MB 11							
		115 - 159	LB 12	140 - 185	MB 14							
254	BH-M250	29 - 62	KK 25 (Bar Jaw)			49	40	16	30			1.5mm x 60°
		48 - 82	LC 04	65 - 100	MC 06	59	40	16	30	25	M8	
		68 - 102	LC 06	85 - 120	MC 08							
		86 - 122	LC 08	104 - 140	MC 10							
		106 - 142	LC 10	124 - 160	MC 12							
		130 - 166	LC 13	145 - 182	MC 14							
		150 - 186	LC 15	165 - 200	MC 16							
		173 - 209	LC 17	185 - 221	MC 18							
315	BH-M315	37 - 102	KK 33 (Bar Jaw)			49	50	21	30			1.5mm x 60°
		60 - 126	LE 05	92 - 159	ME 08	59	50	21	30	25	M8	
		115 - 182	LE 10	156 - 223	ME 14							
		179 - 246	LE 16	215 - 283	ME 20							
		246 - 315	LE 23									

Adjustagrip Jaws are available on request in special sizes or to suit other chuck types.

Adjustagrip Hard Top Jaws

To suit Power Chucks
60° SERRATIONS

Material:

- Steel: 590M17

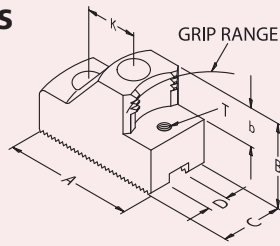

EXTERNAL GRIP

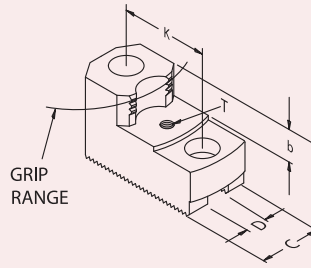

INTERNAL GRIP

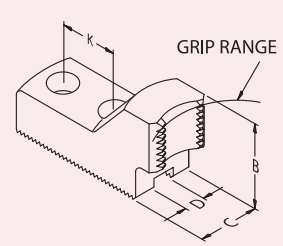

BAR GRIPPING

To suit • SMW-Autoblok Chuck Series AL-M

CHUCK Ø	TYPE	EXTERNAL GRIP RANGES	EXTERNAL GRIP JAW PART No	INTERNAL GRIP RANGES	INTERNAL GRIP JAW PART No	B	C	D	K	b	T	SERRATION
165	AL-M165	13 - 40	KK 16 (Bar Jaw)			39	35	12	20			1.5mm x 60°
		27 - 54	LA 03	47 - 75	MA 05	49	40	12	20	20	M6	
		45 - 79	LA 04	58 - 87	MA 06							
		58 - 88	LA 06	76 - 107	MA 07							
		73 - 103	LA 07	99 - 129	MA 09							
		89 - 119	LA 09									
210	AL-M210	23 - 54	KK 20 (Bar Jaw)			49	40	14	25			1.5mm x 60°
		45 - 77	LB 03	63 - 94	MB 06	49	40	14	25	20	M6	
		74 - 105	LB 06	92 - 125	MB 08							
		102 - 134	LB 09	125 - 158	MB 11							
		129 - 162	LB 12	155 - 187	MB 14							
254	AL-M250	34 - 68	KK 25 (Bar Jaw)			49	40	16	30			1.5mm x 60°
		53 - 87	LC 04	71 - 106	MC 06	59	40	16	30	25	M8	
		73 - 107	LC 06	91 - 126	MC 08							
		92 - 128	LC 08	110 - 146	MC 10							
		112 - 148	LC 10	130 - 161	MC 12							
		135 - 172	LC 13	151 - 188	MC 14							
		155 - 192	LC 15	171 - 195	MC 16							
		179 - 215	LC 17	191 - 227	MC 18							
315	AL-M315	32 - 107	KK 33 (Bar Jaw)			49	50	21	30			1.5mm x 60°
		54 - 131	LE 05	85 - 164	ME 08	59	50	21	30	25	M8	
		109 - 187	LE 10	149 - 228	ME 14							
		172 - 252	LE 16	208 - 288	ME 20							
		239 - 320	LE 23									

Workpiece Height Pins

See page 165



Adjustagrip Jaws are available on request in special sizes or to suit other chuck types.

Adjustagrip Hard Top Jaws

To suit Power Chucks
60° SERRATIONS

Material:

- Steel: 590M17

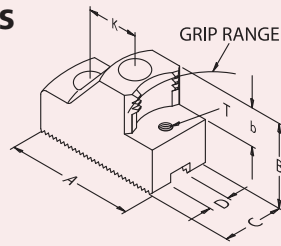

EXTERNAL GRIP

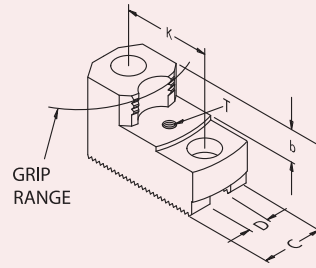

INTERNAL GRIP

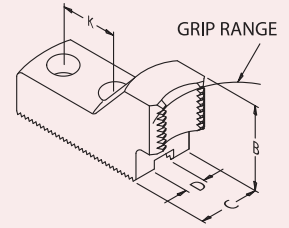

BAR GRIPPING

Serrated Hard Top Jaws

To suit • SMW-Autoblok Chuck Series AN-M

CHUCK Ø	TYPE	EXTERNAL GRIP RANGES	EXTERNAL GRIP JAW PART No	INTERNAL GRIP RANGES	INTERNAL GRIP JAW PART No	B	C	D	K	b	T	SERRATION
165	AN-M165	13 - 37	KK 16 (Bar Jaw)	46 - 73 55 - 85 74 - 104 96 - 126	MA 05 MA 06 MA 07 MA 09	39	35	12	20	20	M6	1.5mm x 60°
		27 - 52	LA 03			49	40	12	20			
		43 - 71	LA 04									
		56 - 86	LA 06									
		70 - 100	LA 07									
		87 - 117	LA 09									
210	AN-M210	20 - 50	KK 20 (Bar Jaw)	59 - 90 89 - 121 121 - 154 151 - 183	MB 06 MB 08 MB 11 MB 14	49	40	14	25	20	M6	1.5mm x 60°
		42 - 74	LB 03			49	40	14	25			
		70 - 101	LB 06									
		98 - 130	LB 09									
		125 - 158	LB 12									
254	AN-M250	30 - 63	KK 25 (Bar Jaw)	66 - 101 86 - 121 105 - 141 125 - 162 146 - 183 166 - 201 186 - 222	MC 06 MC 08 MC 10 MC 12 MC 14 MC 16 MC 18	49	40	16	30	25	M8	1.5mm x 60°
		49 - 83	LC 04			59	40	16	30			
		69 - 103	LC 06									
		87 - 123	LC 08									
		107 - 143	LC 10									
		131 - 167	LC 13									
		151 - 187	LC 15									
		174 - 210	LC 17									
315	AN-M315	28 - 101	KK 33 (Bar Jaw)	79 - 158 143 - 222 201 - 282	ME 08 ME 14 ME 20	49	50	21	30	25	M8	1.5mm x 60°
		49 - 124	LE 05			59	50	21	30			
		103 - 181	LE 10									
		166 - 246	LE 16									
		233 - 313	LE 23									

Adjustagrip Jaws are available on request in special sizes or to suit other chuck types.

Adjustagrip Hard Top Jaws

To suit Power Chucks
60° SERRATIONS

Material:

- Steel: 590M17

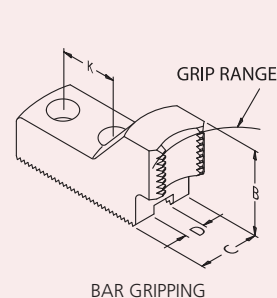
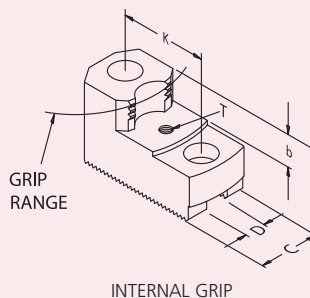
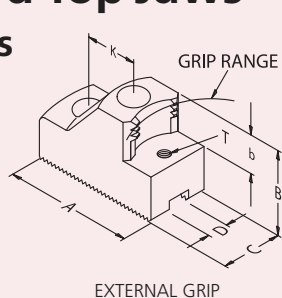

To suit • Tonfou Chuck Series TF3B

CHUCK Ø	TYPE	EXTERNAL GRIP RANGES	EXTERNAL GRIP JAW PART No	INTERNAL GRIP RANGES	INTERNAL GRIP JAW PART No	B	C	D	K	b	T	SERRATION
169	TF3B-06	14 - 32	KK 16 (Bar Jaw)			39	35	12	20			1.5mm x 60°
		27 - 47	LA 03	46 - 68	MA 05	49	35	12	20	20	M6	
		37 - 66	LA 04	49 - 80	MA 06							
		50 - 81	LA 06	68 - 99	MA 07							
		64 - 95	LA 07	90 - 121	MA 09							
		81 - 112	LA 09									
210	TF3B-08	16 - 44	KK 20 (Bar Jaw)			49	40	14	25			1.5mm x 60°
		32 - 68	LB 03	51 - 85	MB 06	49	40	14	25	20	M6	
		60 - 95	LB 06	78 - 115	MB 08							
		88 - 124	LB 09	111 - 148	MB 11							
		115 - 152	LB 12	140 - 177	MB 14							
254	TF3B-10	26 - 65	KK 25 (Bar Jaw)			49	40	16	30			1.5mm x 60°
		45 - 84	LC 04	61 - 103	MC 06	59	40	16	30	25	M8	
		82 - 125	LC 08	100 - 143	MC 10							
		125 - 168	LC 13	141 - 184	MC 14							
		168 - 212	LC 17	180 - 224	MC 18							
304	TF3B-12	28 - 88	KK 33 (Bar Jaw)			49	50	21	30			1.5mm x 60°
		49 - 111	LE 05	79 - 145	ME 08	59	50	21	30	25	M8	
		102 - 168	LE 10	142 - 209	ME 14							
		166 - 233	LE 16	201 - 268	ME 20							
		233 - 300	LE 23	262 - 330	ME 26							
381	TF3B-15	50 - 107	LF 05	100 - 161	MF 10	79	60	22	43	33	M8	1.5mm x 60°
		100 - 161	LF 10	160 - 224	MF 16							
		160 - 224	LF 16	223 - 287	MF 22							
		221 - 285	LF 22	280 - 344	MF 28							
		280 - 344	LF 28	339 - 404	MF 34							
		339 - 404	LF 34									

Adjustagrip Jaws are available on request in special sizes or to suit other chuck types.

Adjustagrip Hard Top Jaws

To suit Power Chucks
60° SERRATIONS

Material:

- Steel: 590M17

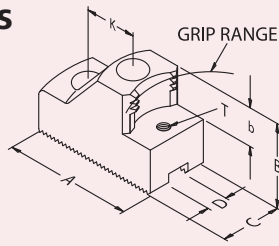

EXTERNAL GRIP

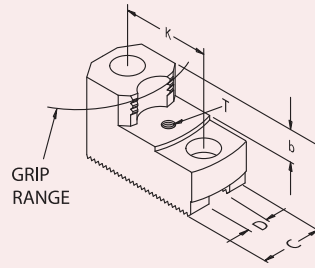

INTERNAL GRIP

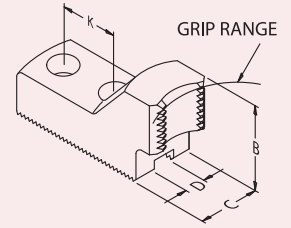

BAR GRIPPING

Serrated Hard Top Jaws

To suit • Tonfou Chuck Series TF3XA

CHUCK Ø	TYPE	EXTERNAL GRIP RANGES	EXTERNAL GRIP JAW PART No	INTERNAL GRIP RANGES	INTERNAL GRIP JAW PART No	B	C	D	K	b	T	SERRATION
175	TF3X-6	14 - 32	KK 16 (Bar Jaw)			39	35	12	20			1.5mm x 60°
		27 - 47	LA 03	46 - 68	MA 05	49	35	12	20	20	M6	
		37 - 66	LA 04	49 - 80	MA 06							
		50 - 81	LA 06	68 - 99	MA 07							
		64 - 95	LA 07	90 - 121	MA 09							
		81 - 112	LA 09									
215	TF3X-8	23 - 49	KK 20 (Bar Jaw)			49	40	14	25			1.5mm x 60°
		45 - 73	LB 03	62 - 91	MB 06	49	40	14	25	20	M6	
		73 - 101	LB 06	91 - 124	MB 08							
		101 - 130	LB 09	124 - 154	MB 11							
		129 - 157	LB 12	154 - 183	MB 14							
254	TF3X-10	26 - 65	KK 25 (Bar Jaw)			49	40	16	30			1.5mm x 60°
		45 - 84	LC 04	61 - 103	MC 06	59	40	16	30	25	M8	
		82 - 124	LC 08	100 - 143	MC 10							
		125 - 168	LC 13	141 - 184	MC 14							
		168 - 212	LC 17	180 - 224	MC 18							

Workpiece Height Pins

See page 165



Adjustagrip Jaws are available on request in special sizes or to suit other chuck types.

Adjustagrip Hard Top Jaws

To suit Power Chucks
60° SERRATIONS

Material:

- Steel: 590M17

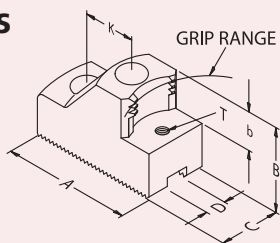

EXTERNAL GRIP

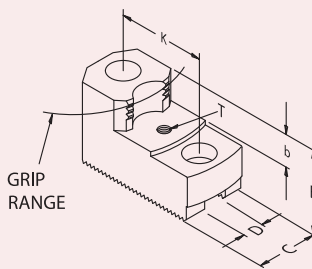

INTERNAL GRIP

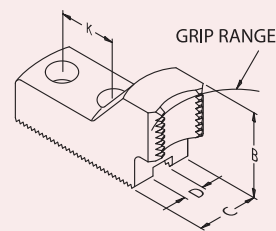

BAR GRIPPING

To suit • Tonfou Chuck Series V

CHUCK Ø	TYPE	EXTERNAL GRIP RANGES	EXTERNAL GRIP JAW PART No	INTERNAL GRIP RANGES	INTERNAL GRIP JAW PART No	B	C	D	K	b	T	SERRATION
165	V-206	14 - 31	KK 16 (Bar Jaw)			39	35	12	20			1.5mmx60°
		27 - 45	LA 03	48 - 66	MA 05	49	35	12	20	20	M6	
		45 - 64	LA 04	59 - 78	MA 06							
		60 - 79	LA 06	78 - 97	MA 07							
		74 - 93	LA 07	100 - 119	MA 09							
		90 - 110	LA 09									
210	V-208	21 - 44	KK 20 (Bar Jaw)			49	40	14	25			1.5mmx60°
		42 - 70	LB 03	60 - 88	MB 06	49	40	14	25	20	M6	
		70 - 98	LB 06	88 - 121	MB 08							
		98 - 125	LB 09	121 - 150	MB 11							
		125 - 151	LB 12	150 - 177	MB 14							
254	V-210	24 - 71	KK 25 (Bar Jaw)			49	40	16	30			1.5mmx60°
		42 - 90	LC 04	59 - 109	MC 06	59	40	16	30	25	M8	
		79 - 130	LC 08	97 - 149	MC 10							
		123 - 175	LC 13	138 - 190	MC 14							
		166 - 218	LC 17	178 - 230	MC 18							
304	V-212	27 - 88	KK 32 (Bar Jaw)			49	50	18	30			1.5mmx60°
		51 - 116	LD 05	79 - 147	MD 08	59	50	18	30	25	M8	
		108 - 176	LD 11	140 - 209	MD 14							
		171 - 241	LD 17	201 - 271	MD 20							
		234 - 304	LD 23	258 - 328	MD 26							

Adjustagrip Jaws are available on request in special sizes or to suit other chuck types.

Adjustagrip Hard Top Jaws

To suit Power Chucks
90° SERRATIONS

Material:

- Steel: 590M17

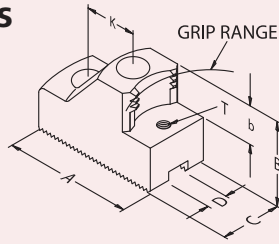

EXTERNAL GRIP

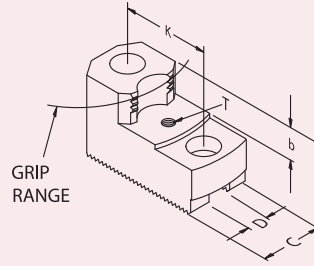

INTERNAL GRIP

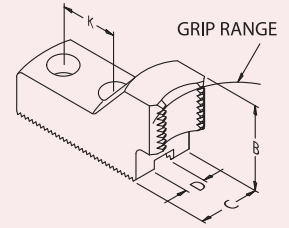

BAR GRIPPING

Serrated Hard Top Jaws

To suit • Berg Chuck Series KH

CHUCK Ø	TYPE	EXTERNAL GRIP RANGES	EXTERNAL GRIP JAW PART No	INTERNAL GRIP RANGES	INTERNAL GRIP JAW PART No	B	C	D	K	b	T	SERRATION
140	KH140	36 - 58	IF 01	ON REQUEST	ON REQUEST	37	30	10	17.5	13	M6	1/16" x 90°
		59 - 83	IF 02									
		83 - 105	IF 03									
		103 - 126	IF 04									
160	KH160	45 - 77	IF 01	ON REQUEST	ON REQUEST	37	30	10	17.5	13	M6	1/16" x 90°
		70 - 102	IF 02									
		93 - 126	IF 03									
		113 - 146	IF 04									
175	KH175	41 - 60	IG 01	ON REQUEST	ON REQUEST	50	35	12	21	20	M6	1/16" x 90°
		58 - 79	IG 02									
		78 - 98	IG 03									
		97 - 118	IG 04									
		117 - 138	IG 05									
		136 - 158	IG 06									
		156 - 177	IG 07									
200	KH200	52 - 83	IG 01	ON REQUEST	ON REQUEST	50	35	12	21	20	M6	1/16" x 90°
		72 - 102	IG 02									
		91 - 122	IG 03									
		110 - 141	IG 04									
		130 - 161	IG 05									
		150 - 181	IG 06									
		170 - 201	IG 07									
250	KH250	53 - 83	IH 01	ON REQUEST	ON REQUEST	60	45	16	29	22	M6	1/16" x 90°
		83 - 110	IH 02									
		109 - 137	IH 03									
		136 - 164	IH 04									
		163 - 192	IH 05									
315	KH315	79 - 144	IH 01	ON REQUEST	ON REQUEST	60	45	16	29	22	M6	1/16" x 90°
		108 - 173	IH 02									
		135 - 201	IH 03									
		162 - 229	IH 04									
		190 - 256	IH 05									

Adjustagrip Jaws are available on request in special sizes or to suit other chuck types.

Adjustagrip Hard Top Jaws

To suit Power Chucks
90° SERRATIONS

Material:

- Steel: 590M17

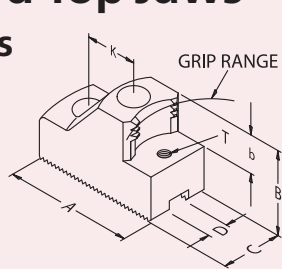

EXTERNAL GRIP

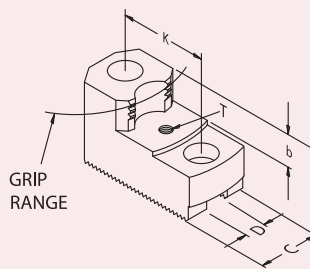

INTERNAL GRIP

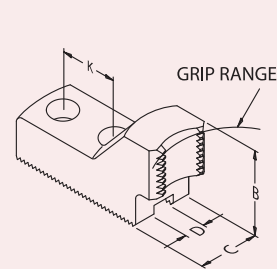

BAR GRIPPING

To suit • Forkardt Chuck Series KS

CHUCK Ø	TYPE	EXTERNAL GRIP RANGES	EXTERNAL GRIP JAW PART No	INTERNAL GRIP RANGES	INTERNAL GRIP JAW PART No	B	C	D	K	b	T	SERRATION
160	KS 160	14 - 26	KJ 16 (Bar Jaw)			39	40	17	19			1/16" x 90°
		34 - 45	IA 03	55 - 65	JA 05	49	40	17	19	20	M6	
		40 - 64	IA 05	62 - 87	JA 07							
		57 - 85	IA 07	82 - 108	JA 09							
		78 - 107	IA 09	97 - 130	JA 11							
200	KS 200	19 - 40	KJ 20 (Bar Jaw)			49	40	17	22			1/16" x 90°
		34 - 56	IB 04	60 - 91	JB 06	49	40	17	22	20	M6	
		56 - 84	IB 05	91 - 122	JB 09							
		83 - 112	IB 08	122 - 151	JB 12							
		112 - 142	IB 11									
141 - 171	IB 14											
250	KS 250	19 - 40	KJ 20 (Bar Jaw)			49	40	17	22			1/16" x 90°
		34 - 105	IB 04	60 - 137	JB 06	49	40	17	22	20	M6	
		56 - 132	IB 05	91 - 169	JB 09							
		83 - 161	IB 08	122 - 201	JB 12							
		112 - 191	IB 11									
141 - 221	IB 14											
315	KS 315	29 - 110	KJ 32 (Bar Jaw)			49	50	21	25			1/16" x 90°
		40 - 147	IC 05	81 - 166	JC 08	59	50	21	25	25	M8	
		80 - 192	IC 08	105 - 220	JC 10							
		128 - 244	IC 13	155 - 271	JC 15							
		179 - 295	IC 18									
400	KS 400	29 - 110	KJ 32 (Bar Jaw)			49	50	21	25			1/16" x 90°
		50 - 195	IC 04	81 - 250	JC 08	59	50	21	25	25	M8	
		80 - 275	IC 08	105 - 303	JC 10							
		128 - 327	IC 13	155 - 355	JC 15							
		179 - 379	IC 18									
500	KS 500	40 - 150	KJ 40 (Bar Jaw)			59	60	25.5	35			3/32" x 90°
		54 - 237	ID 06	96 - 283	JD 10	79	60	25.5	35	33	M8	
		95 - 325	ID 13	129 - 363	JD 17							
		178 - 412	ID 21	207 - 442	JD 25							
		226 - 502	ID 30									
630	KS 630	40 - 150	KJ 40 (Bar Jaw)			59	60	25.5	35			3/32" x 90°
		73 - 363	ID 06	118 - 410	JD 10	79	60	25.5	35	33	M8	
		158 - 452	ID 13	194 - 489	JD 17							
		294 - 539	ID 21	273 - 569	JD 25							
		332 - 629	ID 30									

Adjustagrip Hard Top Jaws

To suit Power Chucks
90° SERRATIONS

Material:

- Steel: 590M17

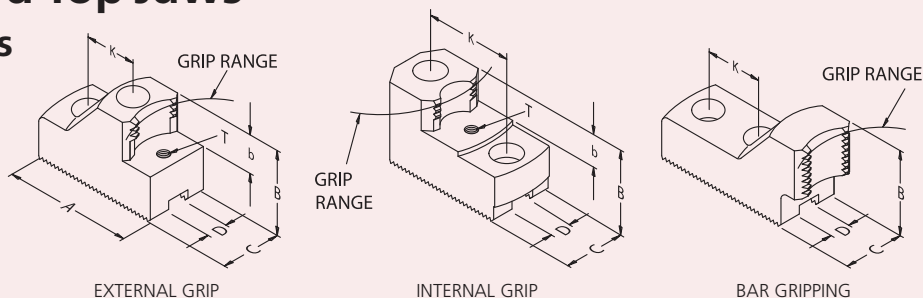

Serrated Hard Top Jaws

To suit • Forkardt Chuck Series KT

CHUCK Ø	TYPE	EXTERNAL GRIP RANGES	EXTERNAL GRIP JAW PART No	INTERNAL GRIP RANGES	INTERNAL GRIP JAW PART No	B	C	D	K	b	T	SERRATION
160	KT 160	15 - 29	KJ 16(Bar Jaw)			39	40	17	19			1/16" x 90°
		34 - 50	IA 03	55 - 68	JA 05	49	40	17	19	20	M6	
		50 - 70	IA 05	75 - 90	JA 07							
		70 - 92	IA 07	95 - 111	JA 09							
		92 - 114	IA 09	117 - 132	JA 11							
		114 - 132	IA 11									
200	KT 200	19 - 42	KJ 20(Bar Jaw)			49	40	17	22			1/16" x 90°
		34 - 59	IB 04	57 - 91	JB 06	49	40	17	22	20	M6	
		53 - 86	IB 05	88 - 123	JB 09							
		80 - 115	IB 08	119 - 154	JB 12							
		109 - 144	IB 11									
		138 - 174	IB 14									
250	KT250	22 - 63	KJ 26(Bar Jaw)			49	50	21	25			1/16" x 90°
		40 - 88	IC 05	81 - 106	JC 08	59	50	21	25	25	M8	
		80 - 133	IC 08	106 - 160	JC 10							
		129 - 184	IC 13	156 - 211	JC 15							
		180 - 235	IC 18									
315	KT 315	29 - 110	KJ 32(Bar Jaw)			49	50	21	25			1/16" x 90°
		40 - 150	IC 05	81 - 169	JC 08	59	50	21	25	25	M8	
		80 - 195	IC 08	106 - 223	JC 10							
		129 - 247	IC 13	156 - 274	JC 15							
		180 - 298	IC 18									
400	KT 400	40 - 95	KJ 40(Bar Jaw)			59	60	25.5	35			3/32" x 90°
		54 - 141	ID 06	96 - 187	JD 10	79	60	25.5	35	33	M8	
		102 - 228	ID 13	137 - 266	JD 17							
		186 - 315	ID 21	214 - 345	JD 25							
		274 - 405	ID 30	298 - 424	JD 33							
500	KT 500	54 - 239	ID 06	96 - 285	JD 10	79	60	25.5	35	33	M8	3/32" x 90°
		102 - 327	ID 13	137 - 365	JD 17							
		186 - 414	ID 21	214 - 444	JD 25							
		274 - 504	ID 30	293 - 524	JD 33							
630	KT 630	54 - 368	ID 06	96 - 414	JD 10	79	60	25.5	35	33	M8	3/32" x 90°
		102 - 456	ID 13	137 - 494	JD 17							
		186 - 544	ID 21	214 - 574	JD 25							
		274 - 634	ID 30	293 - 653	JD 33							

Adjustagrip Jaws are available on request in special sizes or to suit other chuck types.

Adjustagrip Hard Top Jaws

To suit Power Chucks
90° SERRATIONS

Material:

- Steel: 590M17

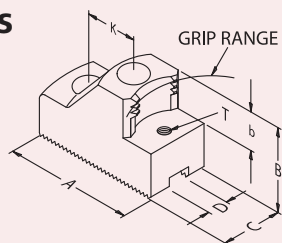

EXTERNAL GRIP

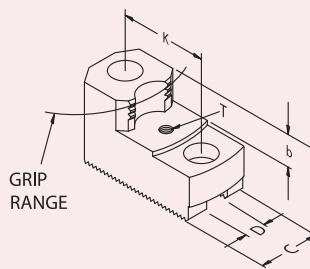

INTERNAL GRIP

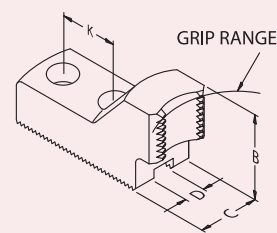

BAR GRIPPING

To suit • Forkardt Chuck Series NH/NHF

CHUCK Ø	TYPE	EXTERNAL GRIP RANGES	EXTERNAL GRIP JAW PART No	INTERNAL GRIP RANGES	INTERNAL GRIP JAW PART No	B	C	D	K	b	T	SERRATION
160	NH 160	25 - 40	KJ 16 (Bar Jaw)			39	40	17	19			1/16" x 90°
	NHF 160	36 - 58	IA 03	56 - 79	JA 05	49	40	17	19	20	M6	
		54 - 77	IA 05	78 - 101	JA 07							
		76 - 99	IA 07	98 - 122	JA 09							
		98 - 121	IA 09	120 - 144	JA 11							
120 - 144	IA 11											
175	NH 175	25 - 40	KJ 16 (Bar Jaw)			39	40	17	19			1/16" x 90°
	NHF 175	44 - 73	IA 03	64 - 93	JA 05	49	40	17	19	20	M6	
		62 - 92	IA 05	86 - 116	JA 07							
		84 - 114	IA 07	107 - 137	JA 09							
		106 - 136	IA 09	128 - 159	JA 11							
128 - 159	IA 11											
200	NH 200	19 - 55	KJ 20 (Bar Jaw)			49	40	17	22			1/16" x 90°
	NHF 200	34 - 72	IB 04	58 - 104	JB 06	49	40	17	22	20	M6	
		55 - 99	IB 05	89 - 136	JB 09							
		82 - 128	IB 08	120 - 167	JB 12							
		110 - 157	IB 11									
140 - 187	IB 14											
250	NH 250	22 - 63	KJ 26 (Bar Jaw)			49	50	21	25			1/16" x 90°
	NHF 250	40 - 88	IC 05	81 - 106	JC 08	59	50	21	25	25	M8	
		80 - 133	IC 08	106 - 160	JC 10							
		129 - 183	IC 13	156 - 211	JC 15							
		179 - 234	IC 18									
315	NH 315	31 - 110	KJ 32 (Bar Jaw)			49	50	21	25			1/16" x 90°
	NHF 315	34 - 122	IC 04	81 - 177	JC 08	59	50	21	25	25	M8	
		60 - 158	IC 05	131 - 231	JC 10							
		104 - 203	IC 08	181 - 282	JC 15							
		154 - 254	IC 13									
205 - 306	IC 18											
400	NH 400	40 - 100	KJ 40 (Bar Jaw)			59	60	25.5	35			3/32" x 90°
	NHF 400	54 - 143	ID 06	96 - 189	JD 10	79	60	25.5	35	33	M8	
		128 - 230	ID 13	164 - 267	JD 17							
		213 - 317	ID 21	242 - 347	JD 25							
301 - 406	ID 30	321 - 426	JD 33									
500	NH 500	76 - 239	ID 06	120 - 285	JD 10	79	60	25.5	35			3/32" x 90°
	NHF 500	160 - 327	ID 13	197 - 365	JD 17							
		246 - 414	ID 21	275 - 444	JD 25							
		335 - 504	ID 30	355 - 524	JD 33							
630	NH 630	98 - 346	ID 06	143 - 411	JD 10	79	60	25.5	35			3/32" x 90°
	NHF 630	184 - 453	ID 13	221 - 490	JD 17							
		270 - 540	ID 21	300 - 570	JD 25							
		359 - 630	ID 30									

Adjustagrip Hard Top Jaws

To suit Power Chucks
90° SERRATIONS

Material:

- Steel: 590M17

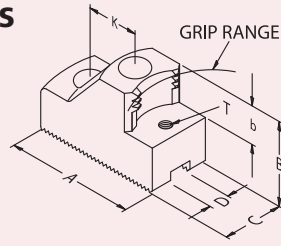

EXTERNAL GRIP

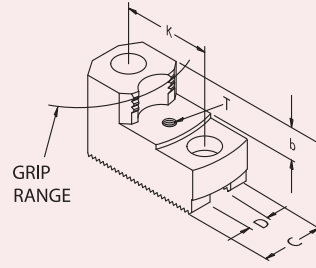

INTERNAL GRIP

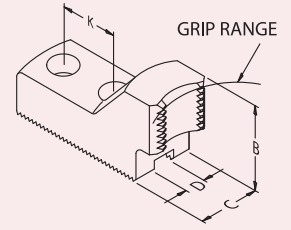

BAR GRIPPING

Serrated Hard Top Jaws

To suit • Forkardt Chuck Series QLC

CHUCK Ø	TYPE	EXTERNAL GRIP RANGES	EXTERNAL GRIP JAW PART No	INTERNAL GRIP RANGES	INTERNAL GRIP JAW PART No	B	C	D	K	b	T	SERRATION
160	QLC 160	18 - 55	KJ 16 (Bar Jaw)	57 - 93 79 - 115 99 - 137 120 - 158	JA 05 JA 07 JA 09 JA 11	39	40	17	19	20	M6	1/16" x 90°
		37 - 72	IA 03			49	40	17	19			
		55 - 91	IA 05									
		77 - 114	IA 07									
		98 - 136	IA 09									
		120 - 158	IA 11									
200	QLC 200	33 - 89	KJ 20 (Bar Jaw)	72 - 127 94 - 149 115 - 171 137 - 193	JA 05 JA 07 JA 09 JA 11	49	40	17	22	20	M6	1/16" x 90°
		51 - 106	IA 03			49	40	17	19			
		70 - 125	IA 05									
		92 - 147	IA 07									
		114 - 170	IA 09									
		137 - 193	IA 11									
250	QLC250	28 - 76	KJ 26 (Bar Jaw)	81 - 120 120 - 173 172 - 224	JC 08 JC 10 JC 15	49	50	21	25	25	M8	1/16" x 90°
		35 - 66	IC 04			59	50	21	25			
		51 - 101	IC 05									
		95 - 146	IC 08									
		145 - 197	IC 13									
		196 - 248	IC 18									
315	QLC 315	33 - 128	KJ 32 (Bar Jaw)	81 - 181 134 - 235 185 - 286	JC 08 JC 10 JC 15	49	50	21	25	25	M8	1/16" x 90°
		35 - 127	IC 04			59	50	21	25			
		63 - 162	IC 05									
		107 - 207	IC 08									
		157 - 259	IC 13									
		209 - 310	IC 18									
400	QLC 400	40 - 96	KJ 40 (Bar Jaw)	97 - 187 166 - 265 244 - 344	JD 10 JD 17 JD 25	59	60	25.5	35	33	M8	3/32" x 90°
		55 - 140	ID 06			79	60	25.5	35			
		131 - 228	ID 13									
		215 - 315	ID 21									
		304 - 404	ID 30									

Adjustagrip Jaws are available on request in special sizes or to suit other chuck types.

Adjustagrip Hard Top Jaws

To suit Power Chucks
90° SERRATIONS

Material:

- Steel: 590M17

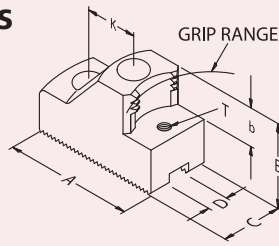

EXTERNAL GRIP

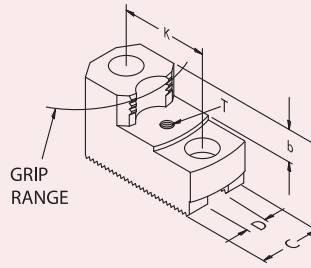

INTERNAL GRIP

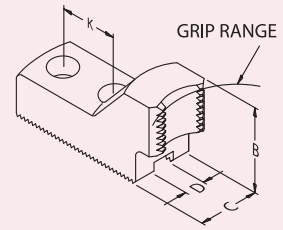

BAR GRIPPING

To suit • Forkardt Chuck Series QLC LS

CHUCK Ø	TYPE	EXTERNAL GRIP RANGES	EXTERNAL GRIP JAW PART No	INTERNAL GRIP RANGES	INTERNAL GRIP JAW PART No	B	C	D	K	b	T	SERRATION
160	QLC LS	22 - 35	KJ 16 (Bar Jaw)			39	40	17	19			1/16" x 90°
	160	40 - 56	IA 03	60 - 74	JA 05	49	40	17	19	20	M6	
		58 - 75	IA 05	82 - 96	JA 07							
		79 - 98	IA 07	103 - 117	JA 09							
		101 - 120	IA 09	124 - 139	JA 11							
		123 - 140	IA 11									
200	QLC LS	25 - 80	KJ 16 (Bar Jaw)			49	40	17	19			1/16" x 90°
	200	43 - 98	IA 03	64 - 118	JA 05	49	40	17	19	20	M6	
		62 - 116	IA 05	86 - 141	JA 07							
		84 - 139	IA 07	107 - 162	JA 09							
		106 - 161	IA 09	128 - 184	JA 11							
		128 - 184	IA 11									
250	QLC LS	23 - 74	KJ 26 (Bar Jaw)			49	50	21	25			1/16" x 90°
	250	35 - 65	IC 04	81 - 117	JC 08	59	50	21	25	25	M8	
		43 - 99	IC 05	112 - 171	JC 10							
		86 - 144	IC 08	162 - 222	JC 15							
		135 - 195	IC 13									
		186 - 246	IC 18									
315	QLC LS	71 - 132	KJ 32 (Bar Jaw)			49	50	21	25			1/16" x 90°
	315	70 - 131	IC 04	123 - 185	JC 08	59	50	21	25	25	M8	
		105 - 166	IC 05	177 - 239	JC 10							
		150 - 211	IC 08	228 - 290	JC 15							
		200 - 263	IC 13									
		252 - 314	IC 18									

Adjustagrip Jaws are available on request in special sizes or to suit other chuck types.

Adjustagrip Hard Top Jaws

To suit Power Chucks
90° SERRATIONS

Material:

- Steel: 590M17

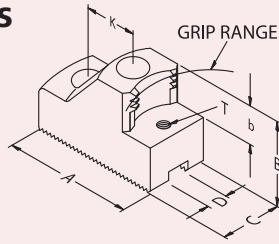

EXTERNAL GRIP

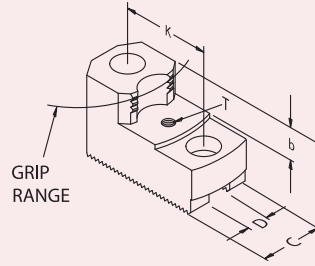

INTERNAL GRIP

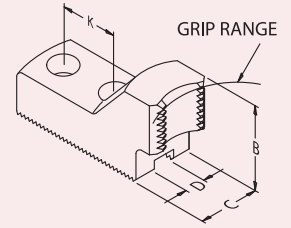

BAR GRIPPING

Serrated Hard Top Jaws

To suit • RÖHM Chuck Series KFD

CHUCK Ø	TYPE	EXTERNAL GRIP RANGES	EXTERNAL GRIP JAW PART No	INTERNAL GRIP RANGES	INTERNAL GRIP JAW PART No	B	C	D	K	b	T	SERRATION
160	KFD 160	14 - 40	KJ 16(Bar Jaw)	55 - 82 71 - 104 92 - 125 113 - 147	JA 05 JA 07 JA 09 JA 11	39	40	17	19	20	M6	1/16" x 90°
		34 - 61	IA 03			49	40	17	19			
		48 - 80	IA 05									
		70 - 102	IA 07									
		91 - 124	IA 09									
		11 - 147	IA 11									
200	KFD 200	19 - 56	KJ 20(Bar Jaw)	62 - 105 93 - 137 124 - 169	JB 06 JB 09 JB 12	49	40	17	22	20	M6	1/16" x 90°
		34 - 73	IB 04			49	40	17	22			
		58 - 100	IB 05									
		86 - 129	IB 08									
		115 - 159	IB 11									
		144 - 188	IB 14									
250	KFD 250	24 - 80	KJ 26(Bar Jaw)	81 - 128 117 - 182 167 - 233	JC 08 JC 10 JC 15	49	50	21	25	25	M8	1/16" x 90°
		47 - 109	IC 05			59	50	21	25			
		91 - 155	IC 08									
		140 - 205	IC 13									
		191 - 257	IC 18									
315	KFD 315	30 - 110	KJ 32(Bar Jaw)	81 - 186 129 - 240 180 - 291	JC 08 JC 10 JC 15	49	50	21	25	25	M8	1/16" x 90°
		58 - 167	IC 05			59	50	21	25			
		152 - 263	IC 13									
		203 - 315	IC 18									
400	KFD 400	40 - 110	KJ 40(Bar Jaw)	96 - 203 159 - 282 237 - 361	JD 10 JD 17 JD 25	59	60	25.5	35	33	M8	3/32" x 90°
		54 - 157	ID 06			79	60	25.5	35			
		123 - 245	ID 13									
		208 - 332	ID 21									
		296 - 421	ID 30									
500	KFD 500	54 - 259	ID 06	96 - 306 170 - 385 248 - 465	JD 10 JD 17 JD 25	79	60	25.5	35	33	M8	3/32" x 90°
		134 - 348	ID 13									
		219 - 435	ID 21									
		308 - 525	ID 30									
630	KFD 630	71 - 387	ID 06	115 - 433 192 - 513 270 - 592	JD 10 JD 17 JD 25	79	60	25.5	35	33	M8	3/32" x 90°
		156 - 475	ID 13									
		241 - 563	ID 21									
		330 - 652	ID 30									

Adjustagrip Jaws are available on request in special sizes or to suit other chuck types.

Adjustagrip Hard Top Jaws

To suit Power Chucks
90° SERRATIONS

Material:

- Steel: 590M17

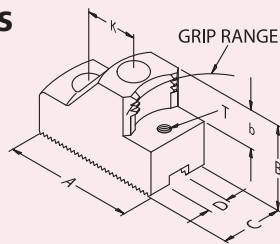

EXTERNAL GRIP

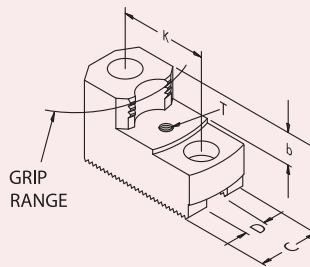

INTERNAL GRIP

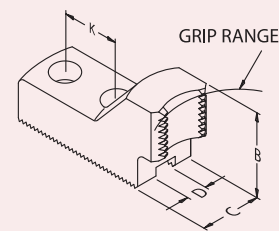

BAR GRIPPING

To suit • RÖHM Chuck Series KFD-HS

CHUCK Ø	TYPE	EXTERNAL GRIP RANGES	EXTERNAL GRIP JAW PART No	INTERNAL GRIP RANGES	INTERNAL GRIP JAW PART No	B	C	D	K	b	T	SERRATION
200	KFD-HS 200	25 - 71	KJ 16(Bar Jaw)			39	40	17	19			1/16" x 90°
		43 - 88	IA 03	64 - 109	JA 05	49	40	17	19	20	M6	
		62 - 107	IA 05	86 - 131	JA 07							
		106 - 152	IA 09	106 - 153	JA 09							
		128 - 174	IA 11	128 - 174	JA 11							
250	KFD-HS 250	21 - 94	KJ 20(Bar Jaw)			49	40	17	22			1/16" x 90°
		38 - 111	IB 04	68 - 143	JB 06	49	40	17	22	20	M6	
		64 - 138	IB 05	100-175	JB 09							
		121 - 197	IB 11	131 - 207	JB 12							
315	KFD-HS 315	30 - 110	KJ 32(Bar Jaw)			49	50	21	25			1/16" x 90°
		40 - 156	IC 05	81 - 175	JC 08	59	50	21	25	25	M8	
		83 - 201	IC 08	109 - 229	JC 10							
		182 - 304	IC 18	159 - 280	JC 15							
400	KFD-HS 400	40 - 110	KJ 40(Bar Jaw)			59	60	25.5	35			3/32" x 90°
		56 - 142	ID 06	97 - 188	JD 10	79	60	25.5	35	33	M8	
		137 - 230	ID 13	173 - 267	JD 17							
		222 - 317	ID 21	251 - 346	JD 25							
500	KFD-HS 500	56 - 240	ID 06	97 - 287	JD 10	79	60	25.5	35	33	M8	3/32" X 90°
		137 - 329	ID 13	173 - 366	JD 17							
		311 - 506	ID 30	251 - 446	JD 25							
				330 - 533	JD 33							

Workpiece Height Pins

See page 165



Adjustagrip Jaws are available on request in special sizes or to suit other chuck types.

Adjustagrip Hard Top Jaws

To suit Power Chucks
90° SERRATIONS

Material:

- Steel: 590M17

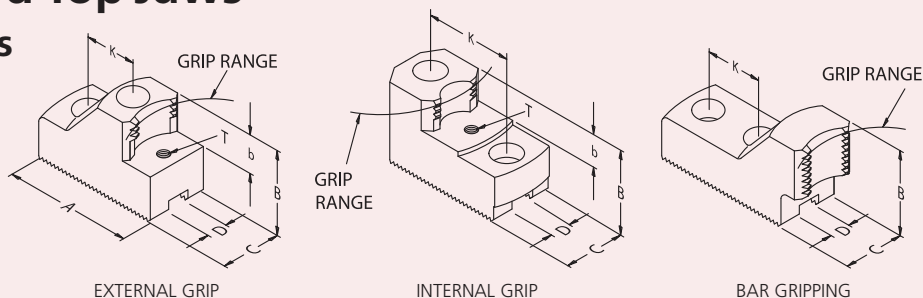

Serrated Hard Top Jaws

To suit • Schunk Chuck Series TH/THF

CHUCK Ø	TYPE	EXTERNAL GRIP RANGES	EXTERNAL GRIP JAW PART No	INTERNAL GRIP RANGES	INTERNAL GRIP JAW PART No	B	C	D	K	b	T	SERRATION
160	TH 165	23 - 59	KJ 16(Bar Jaw)			39	40	17	19			1/16" x 90°
	THF 165	41 - 76	IA 03	61 - 97	JA 05	49	40	17	19	20	M6	
		60 - 95	IA 05	83 - 120	JA 07							
		81 - 118	IA 07	104 - 141	JA 09							
		103 - 140	IA 09	125 - 162	JA 11							
		125 - 162	IA 11									
200	TH 210	23 - 72	KJ 20(Bar Jaw)			49	40	17	22			1/16" x 90°
	THF 210	34 - 77	IB 03	70 - 121	JB 06	49	40	17	22	20	M6	
		39 - 89	IB 04	102 - 153	JB 09							
		66 - 116	IB 05	133 - 185	JB 12							
		94 - 145	IB 08									
		123 - 175	IB 11									
152 - 205	IB 14											
250	TH 250	28 - 93	KJ 26(Bar Jaw)			49	50	21	25			1/16" x 90°
	THF 250	34 - 83	IC 04	81 - 136	JC 08	59	50	21	25	25	M8	
		52 - 118	IC 05	122 - 190	JC 10							
		96 - 163	IC 08	172 - 241	JC 15							
		145 - 214	IC 13									
		196 - 265	IC 18									
315	TH 315	50 - 110	KJ 32(Bar Jaw)			49	50	21	25			1/16" x 90°
	THF 315	49 - 136	IC 04	100 - 191	JC 08	59	50	21	25	25	M8	
		82 - 172	IC 05	154 - 244	JC 10							
		127 - 217	IC 08	205 - 296	JC 15							
		177 - 268	IC 13									
		229 - 320	IC 18									
400	TH 400	72 - 110	KJ 40(Bar Jaw)			59	60	25.5	35			3/32" x 90°
	THF 400	69 - 154	ID 06	113 - 201	JD 10	79	60	25.5	35	33	M8	
		153 - 242	ID 13	189 - 279	JD 17							
		238 - 329	ID 21	267 - 359	JD 25							
		327 - 418	ID 30									
500	TH 500	115 - 272	ID 06	161 - 318	JD 10	79	60	25.5	35	33	M8	3/32" x 90°
	THF 500	202 - 360	ID 13	239 - 397	JD 17							
		289 - 447	ID 21	318 - 477	JD 25							
		378 - 537	ID 30									

Adjustagrip Jaws are available on request in special sizes or to suit other chuck types.

Adjustagrip Hard Top Jaws

To suit Power Chucks
90° SERRATIONS

Material:

- Steel: 590M17

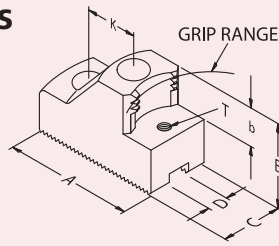

EXTERNAL GRIP

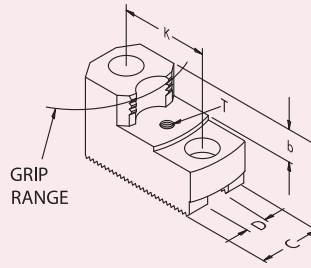

INTERNAL GRIP

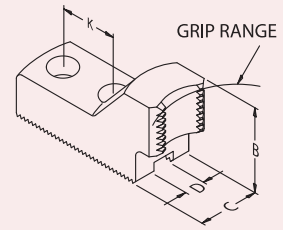

BAR GRIPPING

To suit • Schunk Chuck Series HSG

CHUCK Ø	TYPE	EXTERNAL GRIP RANGES	EXTERNAL GRIP JAW PART No	INTERNAL GRIP RANGES	INTERNAL GRIP JAW PART No	B	C	D	K	b	T	SERRATION
200	HSG 200	49 - 96	KJ 16(Bar Jaw)			39	40	17	19			1/16" x 90°
		67 - 113	IA 03	88 - 134	JA 05	49	40	17	19	20	M6	
		86 - 132	IA 05	110 - 156	JA 07							
		109 - 154	IA 07	132 - 178	JA 09							
		131 - 177	IA 09	153 - 200	JA 11							
		153 - 200	IA 11									
250	HSG 250	77 - 125	KJ 16(Bar Jaw)			39	40	17	19			1/16" x 90°
		95 - 142	IA 03	115 - 163	JA 05	49	40	17	19	20	M6	
		114 - 161	IA 05	138 - 185	JA 07							
		136 - 183	IA 07	159 - 207	JA 09							
		158 - 206	IA 09	181 - 228	JA 11							
		181 - 228	IA 11									
315	HSG 315	61 - 137	KJ 32(Bar Jaw)			49	50	21	25			1/16" x 90°
		60 - 135	IC 04	112 - 190	JC 08	59	50	21	25	25	M8	
		94 - 170	IC 05	166 - 243	JC 10							
		139 - 216	IC 08	218 - 295	JC 15							
		190 - 267	IC 13									
		241 - 319	IC 18									
400	HSG 400	40 - 112	KJ 40(Bar Jaw)			59	60	25.5	35			3/32" x 90°
		64 - 157	ID 06	108 - 203	JD 10	79	60	25.5	35	33	M8	
		148 - 245	ID 13	184 - 282	JD 17							
		233 - 332	ID 21	262 - 361	JD 25							
		322 - 421	ID 30									
500	HSG 500	54 - 202	KJ 40(Bar Jaw)			59	60	25.5	35			3/32" x 90°
		96 - 247	ID 06	141 - 294	JD 10	79	60	25.5	35	33	M8	
		182 - 336	ID 13	219 - 373	JD 17							
		268 - 423	ID 21	298 - 453	JD 25							
		357 - 512	ID 30									

Adjustagrip Jaws are available on request in special sizes or to suit other chuck types.

Adjustagrip Hard Top Jaws

To suit Power Chucks
90° SERRATIONS

Material:

- Steel: 590M17

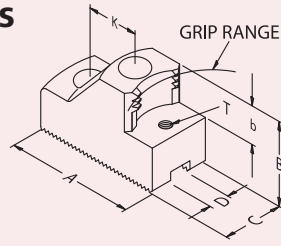

EXTERNAL GRIP

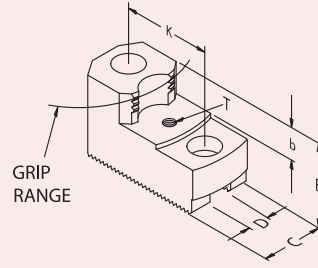

INTERNAL GRIP

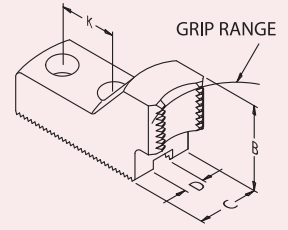

BAR GRIPPING

Serrated Hard Top Jaws

To suit • Schunk Chuck Series HSL

CHUCK Ø	TYPE	EXTERNAL GRIP RANGES	EXTERNAL GRIP JAW PART No	INTERNAL GRIP RANGES	INTERNAL GRIP JAW PART No	B	C	D	K	b	T	SERRATION
165	HSL 165	27 - 55	KJ 16(Bar Jaw)	66 - 93 88 - 115 109 - 137 130 - 158	JA 05 JA 07 JA 09 JA 11	39 49	40 40	17 17	19 19	20	M6	1/16" x 90°
		45 - 72	IA 03									
		64 - 91	IA 05									
		86 - 114	IA 07									
		108 - 136	IA 09									
		130 - 158	IA 11									
210	HSL 210	41 - 87	KJ 16(Bar Jaw)	80 - 125 102 - 148 123 - 169 145 - 191	JA 05 JA 07 JA 09 JA 11	39 49	40 40	17 17	19 19	20	M6	1/16" x 90°
		59 - 104	IA 03									
		78 - 123	IA 05									
		100 - 146	IA 07									
		122 - 168	IA 09									
		145 - 191	IA 11									
250	HSL250	27 - 85	KJ 26(Bar Jaw)	81 - 128 121 - 182 171 - 233	JC 08 JC 10 JC 15	49 59	50 50	21 21	25 25	25	M8	1/16" x 90°
		35 - 75	IC 04									
		51 - 110	IC 05									
		95 - 155	IC 08									
		144 - 206	IC 13									
		195 - 257	IC 18									
315	HSL 315	46 - 127	KJ 32(Bar Jaw)	96 - 180 150 - 234 201 - 285	JC 08 JC 10 JC 15	49 59	50 50	21 21	25 25	25	M8	1/16" x 90°
		46 - 126	IC 04									
		78 - 161	IC 05									
		123 - 206	IC 08									
		174 - 257	IC 13									
		225 - 309	IC 18									

Workpiece Height Pins



See page 165

Adjustagrip Jaws are available on request in special sizes or to suit other chuck types.

Adjustagrip Hard Top Jaws

To suit Power Chucks
90° SERRATIONS

Material:

- Steel: 590M17

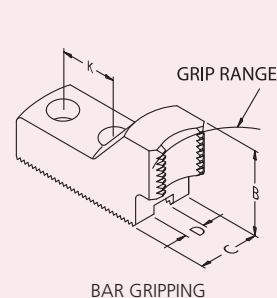
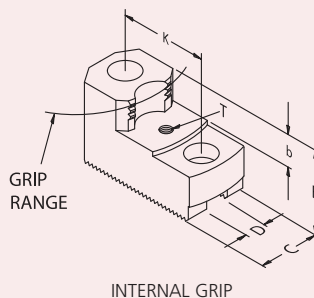
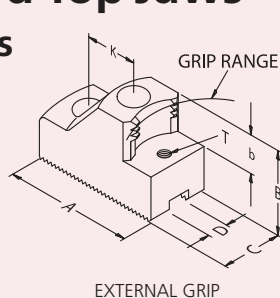

To suit • Schunk Chuck Series Rota NC/NCF

CHUCK Ø	TYPE	EXTERNAL GRIP RANGES	EXTERNAL GRIP JAW PART No	INTERNAL GRIP RANGES	INTERNAL GRIP JAW PART No	B	C	D	K	b	T	SERRATION
160	ROTANC165	18 - 47	KJ 16(Bar Jaw)			39	40	17	19			1/16" x 90°
	ROTANCF165	36 - 64	IA 03	57 - 85	JA 05	49	40	17	19	20	M6	
		55 - 83	IA 05	78 - 107	JA 07							
		76 - 106	IA 07	99 - 129	JA 09							
		98 - 128	IA 09	120 - 150	JA 11							
		120 - 150	IA 11									
200	ROTANC210	27 - 64	KJ 20(Bar Jaw)			49	40	17	22			1/16" x 90°
	ROTANCF210	35 - 69	IB 03	75 - 113	JB 06	49	40	17	22	20	M6	
		44 - 81	IB 04	107 - 145	JB 09							
		71 - 108	IB 05	138 - 176	JB 12							
		99 - 137	IB 08									
		128 - 166	IB 11									
158 - 196	IB 14											
250	ROTANC250	26 - 85	KJ 26(Bar Jaw)			49	50	21	25			1/16" x 90°
	ROTANCF250	35 - 75	IC 04	81 - 128	JC 08	59	50	21	25	25	M8	
		49 - 110	IC 05	119 - 182	JC 10							
		93 - 155	IC 08	169 - 233	JC 15							
		142 - 206	IC 13									
		193 - 257	IC 18									
315	ROTANC315	41 - 137	KJ 32(Bar Jaw)			49	50	21	25			1/16" x 90°
	ROTANCF315	41 - 135	IC 04	90 - 190	JC 08	59	50	21	25	25	M8	
		72 - 170	IC 05	144 - 243	JC 10							
		117 - 215	IC 08	195 - 295	JC 15							
		167 - 267	IC 13									
		218 - 318	IC 18									
400	ROTANC400	41 - 117	KJ 40(Bar Jaw)			59	60	25.5	35			3/32" x 90°
	ROTANCF400	60 - 162	ID 06	103 - 208	JD 10	79	60	25.5	35	33	M8	
		143 - 249	ID 13	179 - 287	JD 17							
		228 - 336	ID 21	257 - 366	JD 25							
		317 - 426	ID 30	336 - 445	JD 33							
500	ROTANC500	111 - 259	ID 06	157 - 306	JD 10	79	60	25.5	35	33	M8	3/32" x 90°
	ROTANCF500	198 - 347	ID 13	234 - 385	JD 17							
		284 - 435	ID 21	313 - 464	JD 25							
		373 - 524	ID 30	393 - 544	JD 33							

Adjustagrip Jaws are available on request in special sizes or to suit other chuck types.

Adjustagrip Hard Top Jaws

To suit Power Chucks
90° SERRATIONS

Material:

- Steel: 590M17

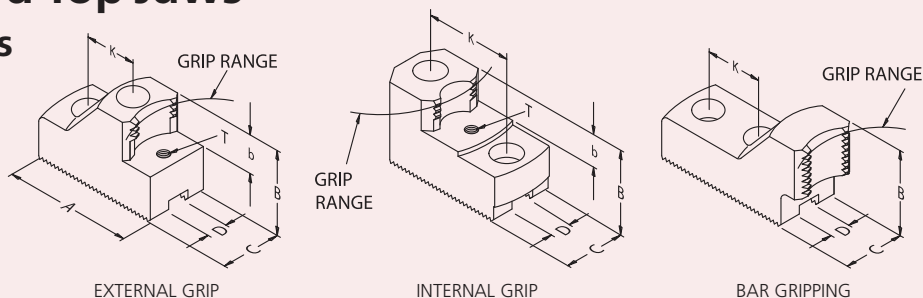

Serrated Hard Top Jaws

To suit • SMW-Autoblok Chucks Series BH-D

CHUCK Ø	TYPE	EXTERNAL GRIP RANGES	EXTERNAL GRIP JAW PART No	INTERNAL GRIP RANGES	INTERNAL GRIP JAW PART No	B	C	D	K	b	T	SERRATION
210	BH-D 210	25 - 56	KJ 20 (Bar Jaw)	58 - 102 89 - 134 120 - 165	JB 06 JB 09 JB 12	49	40	17	22	20	M6	1/16" x 90°
		34 - 70	IB 04									
		55 - 97	IB 05									
		82 - 126	IB 08									
		111 - 156	IB 11									
140 - 185	IB 14											
250	BH-D 250	30 - 70	KJ 26 (Bar Jaw)	81 - 114 114 - 166 165 - 217	JC 08 JC 10 JC 15	49	50	21	25	25	M8	1/16" x 90°
		45 - 94	IC 05									
		89 - 139	IC 08									
		138 - 189	IC 13									
		188 - 241	IC 18									
315	BH-D 315	67 - 110	KJ 32 (Bar Jaw)	89 - 172 144 - 226 194 - 277	JC 08 JC 10 JC 15	49	50	21	25	25	M8	1/16" x 90°
		50 - 118	IC 04									
		117 - 198	IC 08									
		167 - 250	IC 13									
		218 - 301	IC 18									

To suit • SMW-Autoblok Chucks Series BB-D

CHUCK Ø	TYPE	EXTERNAL GRIP RANGES	EXTERNAL GRIP JAW PART No	INTERNAL GRIP RANGES	INTERNAL GRIP JAW PART No	B	C	D	K	b	T	SERRATION
210	BB-D 210	19 - 53	KJ20 (Bar Jaw)	72 - 105 104 - 137 135 - 168	JB 06 JB 09 JB 12	49	40	17	22	20	M6	1/16" x 90°
		41 - 73	IB04									
		68 - 100	IB05									
		96 - 129	IB08									
		125 - 158	IB11									
155 - 188	IB14											
250	BB-D 250	23 - 69	KJ26 (Bar Jaw)	81 - 113 124 - 167 175 - 218	JC 08 JC 10 JC 15	49	50	21	25	25	M8	1/16" x 90°
		54 - 98	IC05									
		98 - 140	IC08									
		147 - 190	IC13									
		198 - 242	IC18									
315	BB-D 315	41 - 110	KJ32 (Bar Jaw)	119 - 173 173 - 225 224 - 276	JC 08 JC 10 JC 15	49	50	21	25	25	M8	1/16" x 90°
		66 - 117	IC04									
		100 - 152	IC05									
		146 - 197	IC08									
		196 - 249	IC13									
248 - 300	IC18											

Adjustagrip Jaws are available on request in special sizes or to suit other chuck types.

Serrated Hard Top Jaws

60° SERRATIONS - REVERSIBLE TYPE

Material:

- Steel: 590M17 or 080M15
- Black Finish

Chuck Ø 110mm - 315mm



TYPE A

TYPE B

PART No.	JAW TYPE	A	B	C	D	K	S1	S2	SERRATIONS
GT 04	B	53	30	25	10	14	10		1.5mm x 60°
GT 05	B	57	32	25	10	18	13		1.5mm x 60°
GT 06	B	66	38	35	12	20	14		1.5mm x 60°
GT 07	A	68	50	35			11	11	
GT 08	A	86	50	35	14	25	11	11	1.5mm x 60°
GT 10	A	99	60	40	16	30	15	15	1.5mm x 60°
GT 12	B	98	60	50	18	30	22		1.5mm x 60°
GT 11	A	103	70	50			17	17	

AUTOSTRONG	HARDINGE (SURE GRIP)	HOWA	KITAGAWA	LEADER	PRATT BURNERD
N204;N205;	4" SURE-GRIP 5" SURE-GRIP		B204; N-04; AS04 B205;AS110 HJA-4; HL04; HOB-5; B-05		
N206;V206; NB206	6" SURE-GRIP	H3KT6	HJA5-6; HOS-6;N-06 HOB-6; AS-165; B206 B-160; HO-06; B-06; NL06 BB-06; HOH-160 HOH-206; HOH-06; B-07 N-160; B-106; BL206 BB206; BS306; DL06; ML06;	LC 165 KHF 165	165 CONSTANT GRIP 170 INTERNATIONAL 165 HIGH SPEED Q C
N208; V208; NB208	8" SURE-GRIP		B208; B-08; HOB-8 N-200;HOH-200; N-08 HOH-8; AS-210; NL08; HOS-8; HJA6-8 HOH-208; HO-8; HOH108; B-108; BB08; BL208 BB208; HG715-210 BS308; ML08; DL08;UVE160K	LC210 KHF 210	210 INTERNATIONAL 210 HIGH SPEED Q C
N210;V210; NB210	10" SURE-GRIP	H3KT10	B250; B-10; HOH-250 HOH-10K; B210; HOB-10 AS-250; N-250; N-10 HJA6-10; HJ8-10; HOS-10 HO-10; NL-10; B-110; UVE-K200; HOH110 UVE-200K; HOH-210; BL210; HG730-254; B210X BB210; BS310; UVE250K	LC250 KHF 250	254 CONSTANT GRIP 254 HIGH SPEED Q C 265 INTERNATIONAL
V212			B300;B-12;HOH-300; HOH-12K; N-300; N-12; HOB-12; HJA6-12; NL-12 HLA6-12; HLA8-15; HLA6-15; UVE315K		305 CONSTANT GRIP 305 HIGH SPEED Q C

Serrated Hard Top Jaws

60° SERRATIONS - REVERSIBLE TYPE

Material:

- Steel: 590M17 or 080M15
- Black Finish

Chuck Ø 110mm - 315mm

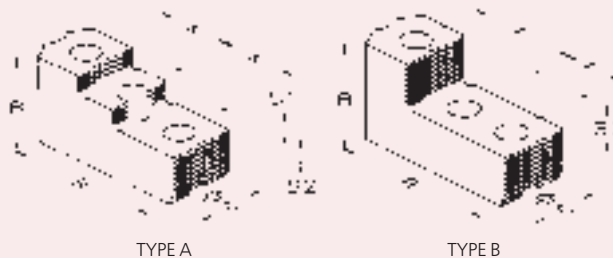

TYPE A

TYPE B

PART No.	JAW TYPE	A	B	C	D	K	S1	S2	SERRATIONS
GT 04	B	53	30	25	10	14	10		1.5mm x 60°
GT 05	B	57	32	25	10	18	13		1.5mm x 60°
GT 06	B	66	38	35	12	20	14		1.5mm x 60°
GT 07	A	68	50	35			11	11	
GT 08	A	86	50	35	14	25	11	11	1.5mm x 60°
GT 10	A	99	60	40	16	30	15	15	1.5mm x 60°
GT 12	B	98	60	50	18	30	22		1.5mm x 60°
GT 11	A	103	70	50			17	17	

RÖHM	SAMCHULLY (POWER GRIP)	SEOAM (ACE)	SCHUNK	SMW-AUTOBLOK	TONFOU
KFD-HE 130; KFN 105	HC-04 HS-04 HS-05	CAS-4; CAH-5			TF3B-04; TF3B-05
	HCH-05	CAS-5			
KFD-HE 170	HCH-06; HC06 HS-06; HH206 MH-206	CAH-6; CAS-6 CGH-6	ROTA NCD 165-185; ROTA NCK 165 ROTA NC/NCF 165; HSL 165; ROTA NCK plus 165; ROTA NC plus 185; ROTA NCF 185	AL-M 165; AN-M 165; BB-M 175; BH-M 165; BH-M FC 165; HB-M 165 HFKN-M 165; PB-M 165; PBI-M 165; AP-M 170; NT-M 170	TF3B-06; TF3X-6 VA-206;
KFD-HE 210	HCH-08; HC-08; HS-08; HH208 MH-208	CAH-8; CAS-8 CGH-8	ROTA NCD 210; ROTA NCK 210; ROTA NC/NCF 210; HSL 210; ROTA NCK plus 210; ROTA NC plus 215; ROTA NCF plus 215	AL-M 210; AN-M 210; BB-M 210; BH-M 210; BH-M FC 210; HB-M 210 HFKN-M 210; PB-M 210; PBI-M 210; AP-M 215; APL-M 215; NT-M 215	TF3B-08; TF3X-8 V-208; VA-208
KFD-HE 254	HCH-10; HC-10; HS-10 HH210 MH-210	CAH-10; CAS-10; CGH-10;	ROTA NCD 250; ROTA NCK 250; ROTA NC/NCF 250; HSL 250; ROTA NCK plus 250; ROTA NC plus 260; ROTA NCF plus 260	AL-M 250; AN-M 250; BB-M 250; BH-M 250; BH-M FC 250; HB-M 250; HFKN-M 260; PB-M 250; PBI-M 250; AP-M 260; APL-M 260; NT-M 260	TF3B-10; TF3X-10 V-210; VA-210;
	HC-12; HCH-12		ROTA NC/NCF 315; HSL 315		V-212; VA-212;

Serrated Hard Top Jaws

60° SERRATIONS - REVERSIBLE TYPE

Material:

- Steel: 590M17 or 080M15
- Black Finish

Chuck Ø 315mm - 800mm



TYPE A

TYPE B

PART No.	JAW TYPE	A	B	C	D	K	S1	S2	SERRATIONS
GT 13	B	98	60	50	21	30	22		1.5mm x 60°
GT 14	A	103	70	50			17	17	
GT 15	A	140	90	60	22	43	22	22	1.5mm x 60°
GT 21	B	178	90	60	25	60	40		3mm x 60°
GT 24	B	219	100	60	25	80	50		3mm x 60°

AUTOSTRONG	HARDINGE (SURE GRIP)	HOWA	KITAGAWA	LEADER	PRATT BURNERD
N212; NB212	12" SURE-GRIP	H3KT12	B212; BL212 BB212;	LC315 KHF 315	
N215;			B380; B-15; HOH-380; HOB-15; HOH-15K; B-450 B-18; HOB-18 HJ-380; HJA-18; HLA-18; HJA-8-21; UVE400K		380 INTERNATIONAL 380 HIGH SPEED Q C
V221;V224			HJ-450; HJ18; B-350; B-21; HJ-530; HJ-21; HOB-21; N-21; B-600; B-24; HJ-610; HJ24; N24; HOB24; UVE-LB500/630		460 CONSTANT GRIP 500 CONSTANT GRIP 610 CONSTANT GRIP 460 HIGH SPEED Q C 500 HIGH SPEED Q C 610 HIGH SPEED Q C
			HOB24; HJA24; HJ24; UVE-LB800		

Serrated Hard Top Jaws

60° SERRATIONS - REVERSIBLE TYPE

Material:

- Steel: 590M17 or 080M15
- Black Finish

Chuck Ø 315mm - 800mm



TYPE A

TYPE B

PART No.	JAW TYPE	A	B	C	D	K	S1	S2	SERRATIONS
GT 13	B	98	60	50	21	30	22		1.5mm x 60°
GT 14	A	103	70	50			17	17	
GT 15	A	140	90	60	22	43	22	22	1.5mm x 60°
GT 21	B	178	90	60	25	60	40		3mm x 60°
GT 24	B	219	100	60	25	80	50		3mm x 60°
GT 32	B	219	100	60	25.5	80	50		3mm x 60°

RÖHM	SAMCHULLY (POWER GRIP)	SEOAM (ACE)	SCHUNK	SMW-AUTOBLOK	TONFOU
KFD-HE 315	HS-12; HH212 MH212	CAH-12	ROTA NCD 315; ROTA NCK 315; HSL 315; ROTA NCK plus 315; ROTA NC plus 315; ROTA NCF plus 315	AL-M 315; AN-M 315; BB-M 305; BB-M 315; BH-M 315; BHM-FC 315; GH-M 400; HB-M 305; HB-M 315; HFKN-M 315; PB-M 315; PBI-M 315; RC-M 305; RC-M 315; RC-M 400; AP-M 315;	TF3B-12
	HCH-15; HCH-18	CAH-15; CAH-18;	ROTA NC/NCF 400; HSL 400		TF3B-15
	HC-21; HC-24; HCH-21; HCH-24	CAH-21			
	HCH-32				

Serrated Hard Top Jaws

60° SERRATIONS - REVERSIBLE TYPE

Material:

- Steel: 590M17 or 080M15
- Black Finish

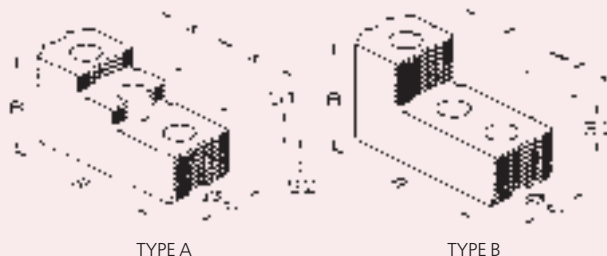

TYPE A

TYPE B

To suit • Howa Power Chucks

PART No.	JAW TYPE	A	B	C	D	K	S1	S2	SERRATIONS	CHUCK Ø	HOWA
GW 06	B	66	40	30	12	20	11		1.5mm x 60°	165Ø	H027M6 H037M6 H023M08
GW 08	B	83	40	40	16	25	13		1.5mm x 60°	210Ø	H027M8 H037M8 H023M 10
GW 10	B	98	50	40	18	30	15		1.5mm x 60°	254Ø	H027M 10 H037M 10 H023M12
GW 12	B	111	60	50	21	35	23		1.5mm x 60°	304Ø	H027M12 H037M12

To suit • MMK Matsumoto Power Chucks

THAME PART No.	JAW TYPE	A	B	C	D	K	S1	S2	SERRATIONS	CHUCK Ø	MMK MATSUMOTO
GT 05	B	57	32	25	10	18	13		1.5mm x 60°	135Ø	HXA5-6-34; HHXA5-6; ZA5-6-40;
GU 06	A	65	35	30	11	20	9	9	1.5mm x 60°	165Ø	HA5-6; HH-6; HX-6; HJ-6; H-6; STC-6; ZA-5-6;
GT 08	A	86	50	35	14	25	11	11	1.5mm x 60°	210Ø	HA6-8; HX-8; H-8; HH-8; HJ-8; HHJ-8; STC-8; ZA-6-8-52;
GT 10	A	99	60	40	16	30	15	15	1.5mm x 60°	254Ø	HA6-10; HA8-10; ZA6-10-75; H-10; HX-10; HHL-10; HH-10; HHJ-10; HJ-10; HA8-11; STC-10;
GT 12	B	98	60	50	18	30	22		1.5mm x 60°	304Ø	HA8-12; HX-12; H-12; SH-12; HH-12; HHL-12; HJ-12; HHJ-12; ZA8-12-78; ZA8-12-85;
GU 15	A	140	90	60	22	44,5	22	22	3mm x 60°	380Ø 450Ø	HA11-15; HHL-15; H-15; HH-15; ZA11-15-120; HA11-18; H-18; HH-18;

Serrated Hard Top Jaws

90° SERRATIONS - REVERSIBLE TYPE

Material:

- Steel: 590M17 or 080M15
- Black Finish

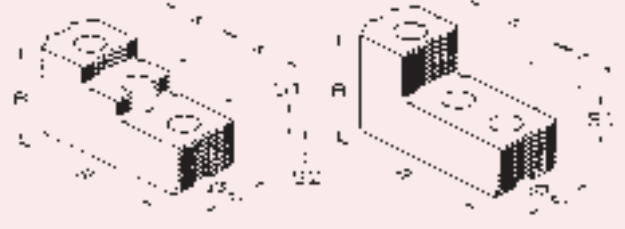

TYPE A

TYPE B

Serrated Hard Top Jaws

To suit • BERG KH Power Chucks

THAME PART No.	JAW TYPE	A	B	C	D	K	S1	S2	SERRATIONS	BERG
HB 211	A	50	34	24	8	14.3	6.5	6.5	1/16" x 90°	KH 110
HB 232	A	66.5	38	25	10	19	6.5	6.5	1/16" x 90°	KH 140; KH 160
HB 237	A	79	44	30	12	21	8	8	1/16" x 90°	KH 175; KH 200
HB 240	A	112	60	40	16	29	12	12	1/16" x 90°	KH 250; KH 315
HB 228	A	144	75	50	20	38	15	15	3/32" x 90°	KH 400; KH 500; KH 630

To suit • Gamet Power Chucks

THAME PART No.	JAW TYPE	A	B	C	D	K	S1	S2	SERRATIONS	GAMET
GR 16	B	65	35	30	11	18.5	17		1/16" x 90°	160N; 160MO; 160GO
GR 20	B	76	44	35	14	22	24		1/16" x 90°	215N; 215MO; 215GO
GR 28	B	94	51	44	20	28	24		1/16" x 90°	250/280N; 200MO; 200GO
GR 35	B	128	65	50	21	40	28		1/16" x 90°	350N; 350MO; 350GO

Serrated Hard Top Jaws

60° SERRATIONS - REVERSIBLE TYPE

Material:

- Steel: 590M17 or 080M15
- Black Finish

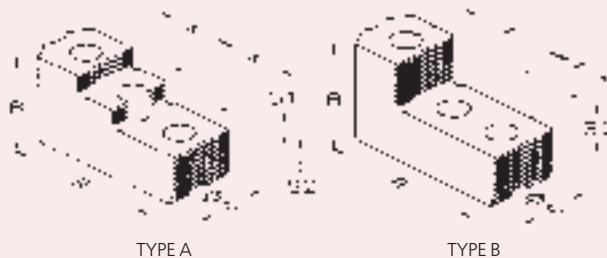

TYPE A

TYPE B

To suit • Howa Power Chucks

THAME PART No.	JAW TYPE	A	B	C	D	K	S1	S2	SERRATIONS	CHUCK Ø	HOWA
GW 06	B	66	40	30	12	20	11		1.5mm x 60°	165Ø	H027M6 H037M6 H023M08
GW 08	B	83	40	40	16	25	13		1.5mm x 60°	210Ø	H027M8 H037M8 H023M 10
GW 10	B	98	50	40	18	30	15		1.5mm x 60°	254Ø	H027M 10 H037M 10 H023M12
GW 12	B	111	60	50	21	35	23		1.5mm x 60°	304Ø	H027M12 H037M12

To suit • MMK Matsumoto Power Chucks

THAME PART No.	JAW TYPE	A	B	C	D	K	S1	S2	SERRATIONS	CHUCK Ø	MMK MATSUMOTO
GT 05	B	57	32	25	10	18	13		1.5mm x 60°	135Ø	HXA5-6-34; HHXA5-6; ZA5-6-40;
GU 06	A	65	35	30	11	20	9	9	1.5mm x 60°	165Ø	HA5-6; HH-6; HX-6; HJ-6; H-6; STC-6; ZA-5-6;
GT 08	A	86	50	35	14	25	11	11	1.5mm x 60°	210Ø	HA6-8; HX-8; H-8; HH-8; HJ-8; HHJ-8; STC-8; ZA-6-8-52;
GT 10	A	99	60	40	16	30	15	15	1.5mm x 60°	254Ø	HA6-10; HA8-10; ZA6-10-75; H-10; HX-10; HHL-10; HH-10; HHJ-10; HJ-10; HA8-11; STC-10;
GT 12	B	98	60	50	18	30	22		1.5mm x 60°	304Ø	HA8-12; HX-12; H-12; SH-12; HH-12; HHL-12; HJ-12; HHJ-12; ZA8-12-78; ZA8-12-85;
GU 15	A	140	90	60	22	44,5	22	22	3mm x 60°	380Ø 450Ø	HA11-15; HHL-15; H-15; HH-15; ZA11-15-120; HA11-18; H-18; HH-18;

AUTOBLOK & SMW-AUTOBLOK	BERG	FORKARDT	GAMET
IDN 170, HDB 170; IDL 170; HDN 170; GHDN 165; GHD-FC 165; AN-D 165; AL-D 16 HFKN-D 165; HYDN—S 180; PB-D 165 PBI-D 165; BB-D 175; BHD-FC 165; HB-D 165			MAC 165/170 DE 170 GA 160/170
AL-D 210; AN-D 210; BB-D 210; BH-D 210 BH-D FC 210; CD 200; GHD-FC 210 GHDN 210; HB-210; HDB 220; HDL 200 IDN 200; IDN 220; IDL 200; HDN 200; HDN 220; HDN 250S; PB-D 210; PBI-D 210 RC-D 210;	KF160; HES160; KHFF 200 KF 200; HES 200; HESF 160 HESF 200;	KGG 160/175/200; KGHF 160/175/200 KG200; KL160; KLNC 200; KP 200 KS 160/200/250; KSF 175/200 KSH 160/200; KSHF 200; KSPS 160/200 KTG 160/200; KTGF 200 KTH 160/ 175/ 200; KTN 160/200 NH 160/175/200; NHF 160/175/200 QLC 160/175/200; QLC-KS 200; QLC-LS 160/200; QLC-AG 200; QLK 160 QLK 175/200; QLK-KS 200; UVE 160/200	MAC 200; MAC 220 DE 210; GA 210
AL-D 210; AN-D 210; BB-D 210; BH-D 210 BH-D FC 210; CD 200; GHD-FC 210 GHDN 210; HB-210; HDB 220; HDL 200 IDN 200; IDN 220; IDL 200; HDN 200; HDN 220; HDN 250S; PB-D 210; PBI-D 210 RC-D 210;	KF 200; HES 200; KHFF 200 HESF 200	KG 200; KGG 200; KGHF 200; KLNC 200 KP 200; KS 200/250; KSF 200; KSH 200 KSHF 200/250; KSPS 200; KT 200 KTG 200; KTGF 200; KTH 200; KTN 200 NH 200; NHF 200; QLC 200; QLC-KS 200/250; QLC-AG 200 QLC-LS 160/200; QLK 200; QLK-KS 200/250; UVE 200/250 NHF 250/290 (INDEX)	MAC 200; MAC 220 DE 210; GA 210
IDN 250; IDN 315; IDN 400; IDL 250; IDL 315 IDL 400; HDN 250; HDN 315; HDN 400 GHDN 250; GHDN 315; GHDN 400; CD 250 CD 315; GHD-FC 250; GHD-FC 305; GHD-FC 400; HDB 300; AN-D 250 AL-D 250; AN-D 315; AL-D 315; BB-D 250; BB-D 315; BH-D 250; BH-D 315 GH-D 400; HB-D 250; HB-D 315; HDB 300 HDL 250; HDL 315; HDL 400; HDN 250 HDN 315; HDN 400; HYDN-S 250; HYDN-S 315 PB-D 250; PB-D 315; PBI-D 250; PBI-D 315 RC-D 250; RC-D 305; RC-D 400	KF 250; HES 250; KHFF 250 HESF 250; KF 315; HES 315 KHFF 315; HESF 315	KG 250/315; KL 250; KLNC 250/315 KP 250/315; KS 315/400 KSH 250/315/400 KSHK 250/315/400; KSPS 250/300 KT 250/315; KTG 250/315; KTGF 250/315 KTN 250/315; NH 250/315; NHF 250/315 QLC 250/315; QLC-KS 315/400 QLC-LS 250/315; QLC-AG 250/315 QLK 250/315; QLK-KS 315/400 UVE 315; NHF 400(INDEX)	MAC 250; MAC 315 DE 250/260/320 GA 250/315
IDN 500; IDN 630; IDN 800 IDL 500; IDL 630; IDL 800 GHDN 500; GHDN 610; GHDN 640; GHDN 800 AL-D 400; AN-D 400 GH-D 500; GH-D 610; GH-D 800 IN-D 500; IN-D 630; IN-D 800 BB-N 400; BB-N 460; BB-N 500 BH-D 400; BH-D 450; BH-D 500; BH-D 630 BH-D 800; BHD-FC 500; BHD-FC 630	KF 400; KF 500; KF630 HES 400; HES 500; HES 630 KHFF 400; KFF 400; KFF 400; KFF 500; KFF 630; HESF 400; HESF 500; HESF 630	KG 400/500; KL 400/500; KLNC 400/500 KP 400/500; KS 500/630 KSH 500; KSHF 630; KSL 630 KS-PS 400; KTG 400/500/630 KTGF 400/500/630; KTN 400/500/630 NH 400/500/630; NHF 400/500/630 QLC 400; QLK 400; UVE 400/500/630/800	DE 400

Serrated Hard Top Jaws

90° SERRATIONS - REVERSIBLE TYPE

Material:

- Steel: 590M17 or 080M15
- Black Finish

Chuck Ø 160mm - 1000mm



TYPE A

TYPE B

THAME PART No.	JAW TYPE	A	B	C	D	K	S1	S2	SERRATIONS
GR 20	B	76	44	35	14	22	24		1/16" x 90°
GY 16	A	67	44	35	17	19	10	10	1/16" x 90°
GY 20	A	74	49	40	17	19	12	12	1/16" x 90°
GY 20	A	74	49	40	17	19	12	12	1/16" x 90°
GY 25	A	104	59	50	21	25	14	14	1/16" x 90°
GY 40	A	126	75	60	25.5	31	18	18	3/32" x 90°

PRATT BURNERD	RÖHM	SCHUNK	SMW
			SP160
160 INTERNATIONAL 160 HIGH SPEED QC 165 HYD. FRONT END 210 INTERNATIONAL 210 HIGH SPEED QC 210 KB INTERNATIONAL 210 KB HIGH SPEED QC 210 CONSTANT GRIP	KFD 160; KFD-AF 160; KFD-HF 160; KFD-HS 200; KFH 160; KFH-F 160; KFH-G 160; KFH-HC 160 SPD 160; SPO 160	HSL 165 ROTA NC 165 ROTA NCD 185 ROTA NCF 165 TH 165 THF 165	HKKS 160/200 KDV 160/200/250 KDBG 160/200/250 KDM 160/200 KDM-F 160/200/250 KMA 160/200/250 KMAF 160/200/250 KFV160/200 SP 200 KFMF 160/200 HFK 160/200
200 INTERNATIONAL 200 HIGH SPEED QC 210 HYD. FRONT END 250 HIGH SPEED QC 254 INTERNATIONAL 265 HIGH SPEED QC 265 KB INTERNATIONAL 265 KB HIGH SPEED QC 254 CONSTANT GRIP	KFD 200; KFD-AF 200; KFD-HE 200; KFD-HF 200 KFD-HS 250; KFH 200; KFH-F 200 KFH-G 200; KFH-NC 200 KFL 250; LVE 200; SPD 215; SPO 215	HSL 210 ROTA NC 210; ROTA NCD 210 ROTA NCF 210; ROTA NCO 210; ROTA TP 200; TH 210; THF 210 TP 200; ROTA NCK 210/250 ROTA NC plus 215; ROTA NCF plus 215	HFKS 200 KDV 200/250 KDBG 200/250 KDM 200 KDM-F 200/250 KMA 200/250 KMA-F 200/250 KFV 200 KFMF 200 HFK 200
250 INTERNATIONAL 254 HYD. FRONT END 305 HYD. FRONT END 305 INTERNATIONAL 305 HIGH SPEED QC 315 INTERNATIONAL 400 HIGH SPEED QC 305 KB INTERNATIONAL 305 KB HIGH SPEED QC 305 CONSTANT GRIP	KFD 250/315; KFD-AF 250/315 KFD-HE 254/315 KFD-HF 250/315 KFD-HS 315 KFH 250/315; KFH-F 250/315 KFH-G 250/315 KFH-NC 250/315 KFL 250/315 LVE 250/305/315 SPD 300; SPO 300	HSL 250; HSL 315; ROTA NC 250/315 ROTA NC plus 260/315; ROTA NCD 250; ROTA NCD 315 ROTA NCF 250; ROTA NCF 315 ROTA NCF plus 260/315 ROTA NCK plus 315 ROTA NCO 260/315 ROTA TP 250; ROTA TP 315 TH 250/315; THF 250/315	HFK 250/315 HFKS 250/315 KDV 315/400 KDBG 315/400 KDM 250/315/400 KDM-F 315/400 KMA 315/400 KMA-F 315
400 INTERNATIONAL 400 HYD. FRONT END 500 HYD. FRONT END	KFD 400/500/630/800 KFD-HE 400 KFD-HF 400/500/630 KFD-HS 400/500 KFH 400/500; KFH-F 400/500 KFH-G 400/500 KFH-NC 400/500 KFL 500/600 LVE 400/500/630/800/1000	HSG 400-500; HSL 400; ROTA NC 400 ROTA NC 500; ROTA NCD 400/500 ROTA NCF 400/500 ROTA NCO 400/500 TH 400; TH 500 THF 400; THF 500	HFK 400/500 HFKS 400/500 KDV 500 KDBG 500 KDM 500 KFV 400/500/630/800

Slot/Tenon Soft
Top Jaws

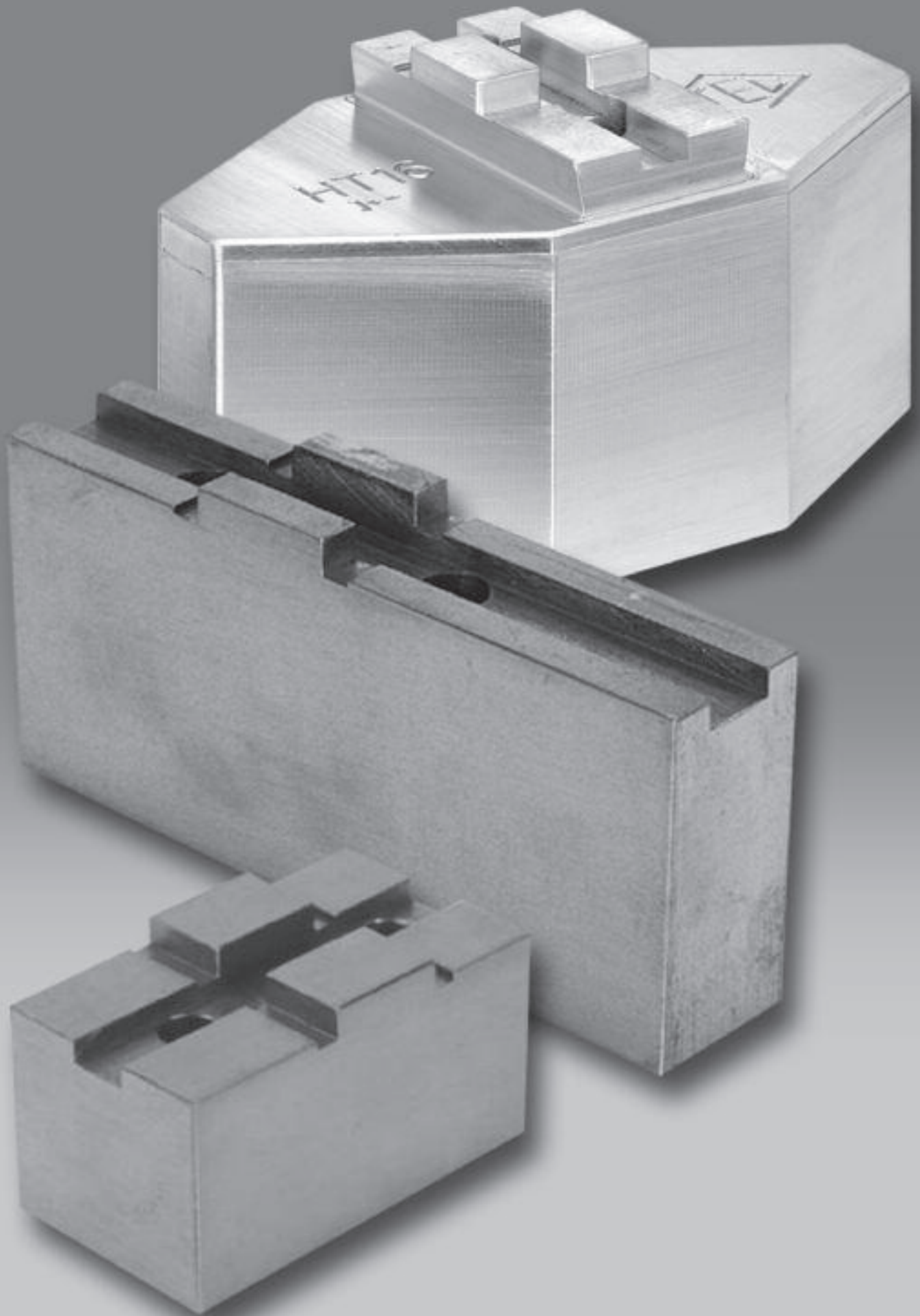

Slot/Tenon Soft Top Jaws

Page

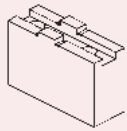

Standard Jaws

- For quick change jaw chucks • Steel • Aluminium

106 - 109

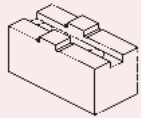

Large and Wide Jaws

- For quick change jaw chucks • Steel

106 - 109

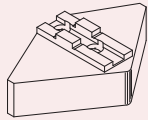

Diamond Jaws

- For quick change jaw chucks • Steel • Aluminium

106 - 109

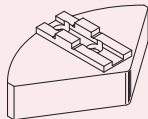

Segment Jaws

- For quick change jaw chucks • Steel • Aluminium

106 - 109

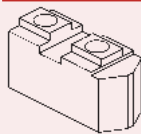

Standard Jaws

- For other slot/tenon power chucks

110

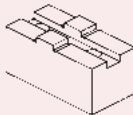

Standard and Large Jaws

- For chucks with American standard base jaws

110

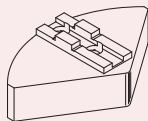

Segment Jaws

- For chucks with American standard base jaws

110

Slot/Tenon Soft
Top Jaws

	Std Jaws Steel and Aluminium	Large and Wide Jaws, Steel	Diamond Jaws Steel and Aluminium	Segment Jaw, Steel	Std Jaw other slot/tenon power chuck	American Std Soft Jaws, Steel
	Page	Page	Page	Page	Page	Page
BERG	106-109	106-109	106-109	106-109		
FORKARDT	106-109	106-109	106-109	106-109		
GAMET	106-109	106-109	106-109	106-109		
KITAGAWA	106-107	106-107	106-107	106-107		
RÖHM	106-109	106-109	106-109	106-109	110	
SAMCHULLY	106-109	106-109	106-109	106-109		
SCHUNK	106-109	106-109	106-109	106-109		
SMW-AUTOBLOK	106-109	106-109	106-109	106-109		
AMERICAN (ASA B5.8)						110

Slot/Tenon Soft Top Jaws

For Quick Jaw Change Chucks

Material

- Steel: 080M15 (En32) • Black Finish
- Aluminium: HE30TF • Natural Finish

Chuck Ø 140mm - 330mm

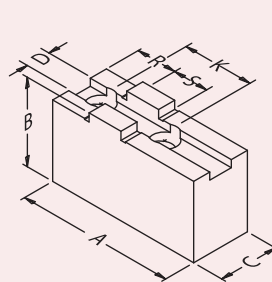

TYPE: GS- STEEL GA - ALUMINIUM

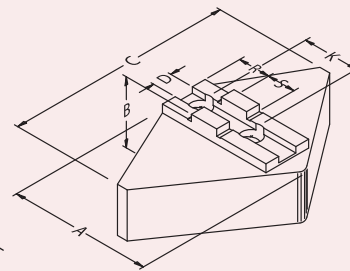

TYPE: HS - STEEL HA - ALUMINIUM

Slot/Tenon Soft Top Jaws

THAME PART No.	JAW TYPE	A	B	C	D	K	R	S	BOLT	WEIGHT Kg/Set
CU 14	GS	69	40	20	8	32	25	18	M8	0.9
CU 141	GS	63	45	30	8	32	19	18	M8	1.7
CU 16	GS	85	40	20	8	32	25	18	M8	1.1
CU 161	GS	85	55	30	8	32	19	18	M8	2.6
DP 16	GS	60	40	40	8	32	17	18	M8	1.8
CU 163	GS	70	60	40	8	32	19	18	M8	3.3
CW 16	GA	85	51	25	8	32	25	18	M8	0.7
CQ 16	HS	60	60	120	8	32		18	M8	9.0
HT 16	HA	62	64	120	8	32		18	M8	3.8
CF 16	IS	73	51	152Ø	8	32		18	M8	7.0
CU 20	GS	105	51	22	10	40	34	20	M8	2.2
CU 201	GS	100	55	30	10	40	23	20	M8	2.9
DP 20	GS	70	40	40	10	40	22	20	M8	2.2
CU 204	GS	85	60	40	10	40	23	20	M8	4.0
CU 205	GS	95	80	40	10	40	23	20	M8	5.8
CW 20	GA	105	51	25	10	40	34	20	M8	0.9
CQ 20	HS	89	64	150	10	40		20	M8	14.0
HT 20	HA	75	64	150	10	40		20	M8	5.9
CF 20	IS	90	51	203Ø	10	40		20	M8	11.0
CU 25	GS	125	55	30	12	40	36	20	M12	3.6
CU 251	GS	90	60	40	12	40	26	20	M12	3.9
CU 252	GS	125	60	40	12	40	26	20	M12	5.8
CU 253	GS	125	80	40	12	40	26	20	M12	7.5
CU 254	GS	125	100	40	12	40	26	20	M12	9.6
CU 255	GS	125	125	40	12	40	26	20	M12	12.0
DP 25	GS	90	60	60	12	40	26	20	M12	6.2
CU 257	GS	90	60	80	12	40	26	20	M12	8.5
CW 25	GA	125	60	40	12	40	36	20	M12	2.0
CQ 25	HS	102	64	170	12	40		20	M12	20.0
HT 25	HA	102	64	170	12	40		20	M12	8.4
CF 25	IS	123	51	254Ø	12	40		20	M12	17.0

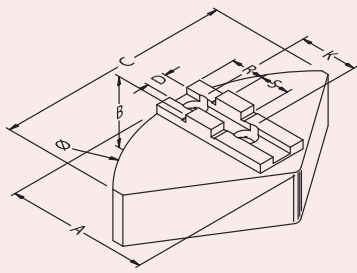

TYPE: IS - STEEL

BERG	FORKARDT	GAMET	KITAGAWA	RÖHM	SAMCHULLY	SCHUNK	SMW-AUTOBLOK
KHNC 140				DURO NC 140 DURO NC 168			KNCS 140 KNCS 140-32 KNCS-N 140-35
KHNC 160 KHNC 185	F160 KTNC 160 KTNCV 175 KTNCV 160 FNC 175 F+160	MX 152 MX 175		DURO 160 DURO NC 160 DURO NCE 160 DURO NC 175 DURO NCE 175 DURO NCES 175	QJC-206	ROTA-G 160 ROTA-S 160 ROTA-S plus 160 ROTA NC-W 185 THW 165R ROTA THW 165 ROTA NCR 200 ROTA THW plus 165 ROTA THW plus 185	RMG 160 HG 160 HG-F 160 HG-N 160 KNSP 160 KNCS 160 KNCS 175 KNC 160 KNCS 170-43 KNCS-N 170-43
KHNC 200	F 200 KTNC 200 KTNCV 200 FNC 200 F+200	MX215	QJ 8	DURO 200 DURO NC 200 DURO NCE 200 DURO NC 225 DURO NCES 200	QJC-208	ROTA-G 200 ROTA-S 200 ROTA-S plus 200 ROTA NC-WF210 ROTA NC-W 225 THW 210 F THW210R ROTA THW plus 215 ROTA THWB 210 ROTA THW vario 215	RMG 200 HG-F210 HG 200 HG-N210 KNSP 200 KNCS 200 KNCS 225 KNCS 210-52 KNCS-N 210-52 KNCS-N 225-65 KNCS-NB 210
KHNC 250 KHNC 315	F 250 KTNC 250 KTNC 280 KTNC 315 KTNCV 250 KTNCV 315 UNC 250/315 FNC 250/315 F+250	MX 252 MX315 MX 330	QJ 10 QJ 12	DURO 250 DURO NC 250 DURO NCE 250 DURO NCE 315 DURO NCES 250 DURO NCES 315	QJC-210 QJC-212	ROTA-G 250 ROTA NC-WF 25C ROTA-S 250 ROTA-S plus 250 ROTA NC-W 265 ROTAG315 ROTA NC-W 315 ROTA NC-WF 315 THW 250F THW 250R THW 265F THW 265R THW 315R ROTA THW 250 -315 ROTA THW plus 260-315 ROTA THWB 265	RMG 250 KNCS 250 KNCS 260 KNCS 315 KNCS 260-71 KNCS 315-91 KNCS-N 260-72 KNCS-N 315-91 HG 250/315 HG-F 260/315 HG-N 260/315 KNCS-NB 260 KNCS-NB 315

Slot/Tenon Soft Top Jaws

For Quick Jaw Change Chucks

Material

- Steel: 080M15 (En32) • Black Finish
- Aluminium: HE30TF • Natural Finish

Chuck Ø 315mm - 800mm

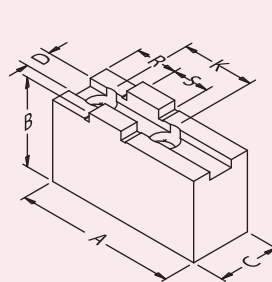

TYPE: GS- STEEL GA - ALUMINIUM

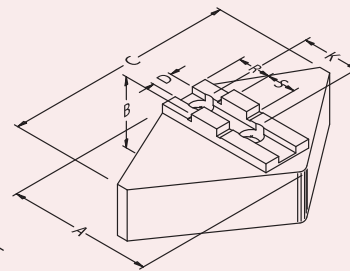

TYPE: HS - STEEL HA - ALUMINIUM

Slot/Tenon Soft Top Jaws

THAME PART No.	JAW TYPE	A	B	C	D	K	R	S	BOLT	WEIGHT Kg/Set
CU 32	GS	145	60	40	12	54	45	26	M12	6.8
CU 321	GS	110	60	40	12	54	30	26	M12	4.9
CU 323	GS	145	100	40	12	54	30	26	M12	11.1
CU 324	GS	145	125	40	12	54	30	26	M12	13.9
CU 325	GS	145	150	40	12	54	30	26	M12	16.9
CU 326	GS	110	60	60	12	54	30	26	M12	7.6
DP 32	GS	100	60	80	12	54	30	26	M12	8.4
CU 328	GS	110	80	80	12	54	30	26	M12	14.1
CU 329	GS	145	80	50	12	54	30	26	M12	11.6
CW 32	GA	145	60	40	12	54	45	26	M12	2.4
CQ 32	HS	132	76	240	12	54		26	M12	28.0
HT 32	HA	133	76	240	12	54		26	M12	10.5
CF 32	IS	148	51	305Ø	12	54		26	M12	23.0
CU 40	GS	180	80	50	18	60	50	30	M16	11.2
CU 401	GS	130	80	60	18	60	35	30	M16	11.9
CU 402	GS	180	80	60	18	60	35	30	M16	16.5
CU 403	GS	155	100	60	18	60	35	30	M16	15.3
CU 404	GS	155	125	60	18	60	35	30	M16	18.7
DP 40	GS	130	80	80	18	60	35	30	M16	16.2
CU 406	GS	155	160	50	18	60		30	M16	25.2
CW 40	GA	180	100	51	18	60	50	30	M16	6.3
CU 407	GS	155	80	80	18	60	35	30	M16	19.3
CU 50	GS	220	100	60	18	76	58	40	M16	28.5
CU 63	GS	260	125	60	24	82	70	40	M20	42.0

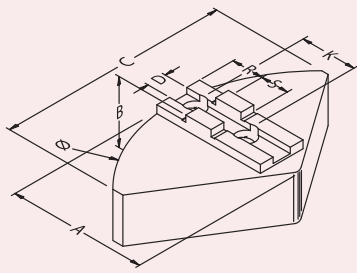

TYPE: IS - STEEL

BERG	FORKARDT	GAMET	KITAGAWA	ROHM	SAMCHULLY	SCHUNK	SMW-AUTOBLOK
KHNC 400	F 315 KTNC 360 KTNC 400 KTNCV 400 UNC 400 FNC 400 F+315	MX 380		DURO 315 DURO NC 315 DURO NCE 400 DURO NCES 315 DURO NCES 400	QJC-215	ROTA-G 400 ROTA-S315 ROTA-S plus 315 ROTA NC-W 400 THW 315F THW 400F THW 400R ROTA THWB 315	RMG-315 KNCS 400 KNCS 400-120 KNCS-N 400-128 HG 400 KNC 400 HG-N400 HG-F 315 KNCS-NB 400
KHNC 500	F 400/500L UNC 500 KTNC 500 KTNC 630 KTNCV 500 KTNCV 630 FNC 500/630 F+400			DURO 400 DURO NC 400 DURO 500 DURO NC 500 DURO NCE 500 DURO NCES 400		ROTA-S 400 ROTA-S plus 400 ROTA-G 500 ROTA-S 500 ROTA-S plus 500 THW 500F THW 500R THW 630R ROTA THW 500-630-800 ROTA THWB 400-500	HG 500 HG 630 HG-F 400/500 HG-N 500/600 KNCS 500 KNCS 630 KNCS 500-160 KNCS 630-160 KNCS-N 500-165 KNCS-N 630-165 KNCS 800-160 KNCS-NB 500-630-800
	F500S						
	F 630 F+630			DURO NC 630 DURO 630		ROTA-G 630 ROTA-S 630-800 ROTA-S plus 630-800	HG-F 630

Slot/Tenon Soft Top Jaws

Material :

- Steel: 080M15
- Black Finish

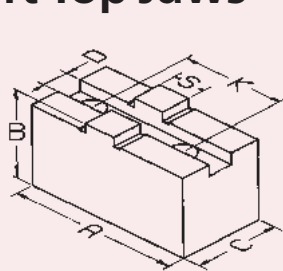

TYPE: GS- STEEL

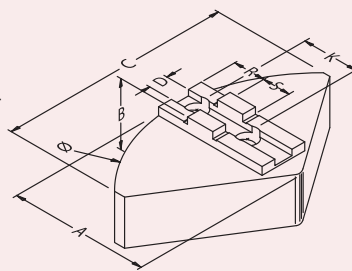

TYPE: IS- STEEL

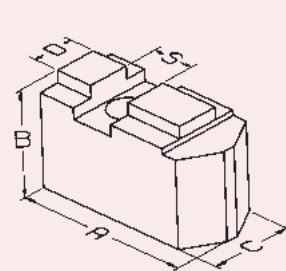

TYPE: HS- STEEL

To suit • Manual & Power Operated Chucks with American (ASA B5.8) & ISO 3442 Base Jaws

THAME PART No.	JAW TYPE	A	B	C	D	K	S	BOLT	WEIGHT Kg/Set	CHUCK Ø
DM 13	GS	56	40	20	6.35	22.2	9.5	M8	1.0	125Ø
DM 16	GS	74	40	25	7.94	38.1	12.7	M8	1.6	160Ø
DH 16	GS	74	60	25					2.4	
DF 16	IS	73	50	152Ø					7.0	
DM 20	GS	87	40	30	7.94	44.5	12.7	M8	2.2	200Ø
DH 20	GS	87	60	30					3.3	
DF 20	IS	97	50	203Ø					11.0	
DM 25	GS	103	50	35	12.7	54	19	M12	3.9	250Ø
DH 25	GS	103	80	35					6.2	
DF 25	IS	123	50	254Ø					17.0	
DM 32	GS	120	60	40	12.7	63.5	19	M12	6.0	315Ø
DH 32	GS	120	80	40					8.0	
DF 32	IS	148	50	305Ø					23.0	
DM 38	GS	137	70	40	12.7	76.2	19	M16	8.1	380Ø
DH 38	GS	137	100	40					11.6	
DM 46	GS	140	80	50	12.7	76.2	19	M20	12.5	460Ø
DH 46	GS	140	100	50					15.6	
DM 48	GS	152	80	60					13.6	

This jaw type is common to a large range of chuck manufacturers such as - Amestra, Autoblok, Bergmann, Bison, Buck, BTC, Cushman, Emco, Ladner, Pratt Burnerd, Rohm, Samchully, SCA, S.P., Strong, TdeG, TOS, Toolmex, plus many others.

To suit • Röhms KFD • Power Operated Chucks

THAME PART No.	JAW TYPE	A	B	C	D	K	S	P	BOLT	WEIGHT Kg/Set	TO SUIT CHUCK TYPE
DN 08	HS	40	30	22.5	8	-	8	3	M8	0.43	ROHM KFD 85
DN 09	HS	44.5	40	22.5	8	-	8	3	M8	0.70	ROHM KFD 95

Slot/Tenon Top Jaw and Chuck Data Sheet

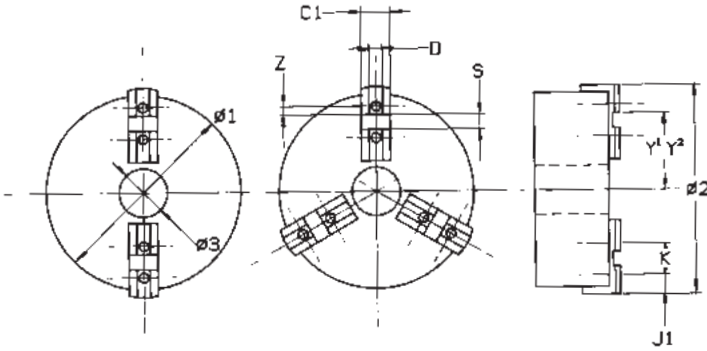

		2 JAW CHUCK DATA	3 JAW CHUCK DATA	REMARKS
Chuck Manufacturer / Model No.				
Chuck Ø / Type	ø1			
Maximum Swing Ø	ø2			
Chuck Bore	ø3			
Base Jaw Width	C1			
Chuck Centre To Rear Of Slot	Y1max Y2 min			
Thread	Z			
Centre Of Hole To Rear Of Base Jaw	J1			
Tenon Width	S			
Slot Width	D			
Tenon To Back Of Jaw	R			
Hole Centre Spacing	K			
Counterbore / Hole Ø	G/F			
Counterbore Depth	H			
Length Of Jaw	A			
Height (Inc. Tenon) Of Jaw	B			
Height Of Tenon	T			
Width Of Jaw	C			

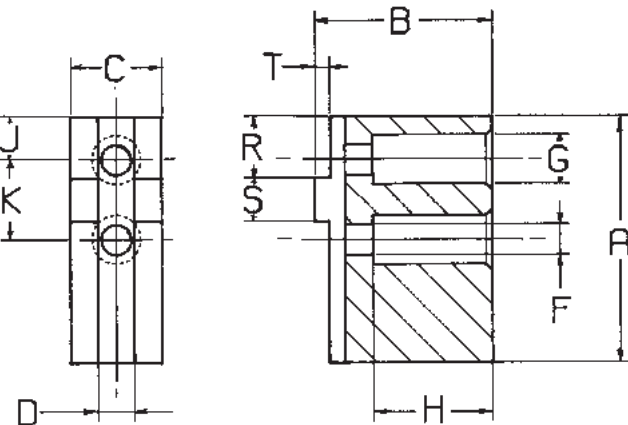

Slot/Tenon Soft Top Jaws

Slot/Tenon Hard
Top Jaws

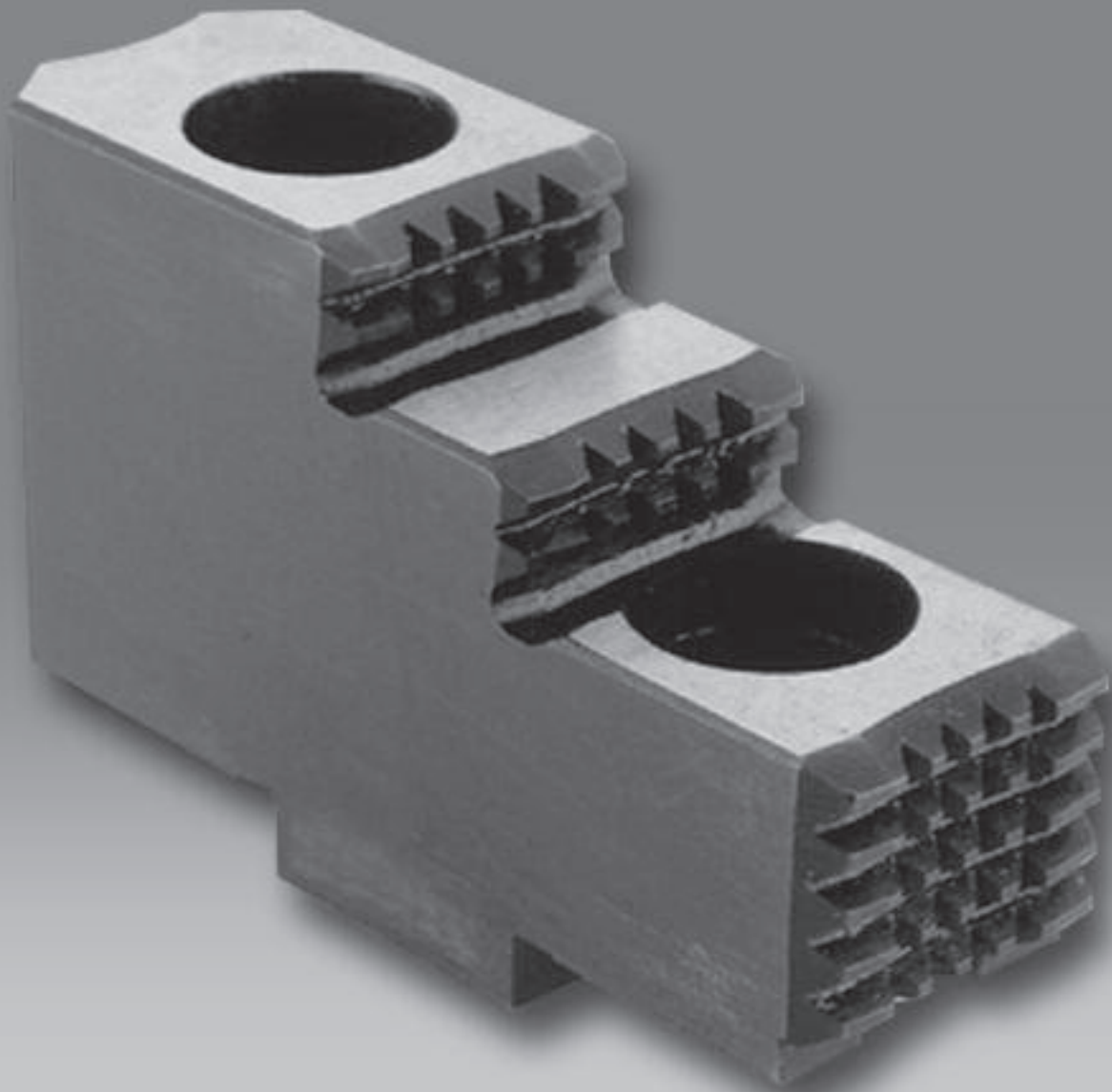

Slot/Tenon Hard Top Jaws

Page

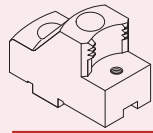

Adjustagrip Hard Jaws

- External clamping
- For quick change jaw chucks

114 - 123

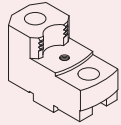

Adjustagrip Hard Jaws

- Internal clamping
- For quick change jaw chucks

114 - 123

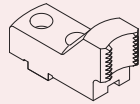

Adjustagrip Hard Jaws

- Bar clamping
- For quick change jaw chucks

114 - 123

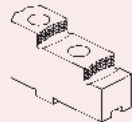

Hard Reversible Jaws

- For quick change jaw chucks

124 - 125

Slot/Tenon Hard
Top Jaws

	Adjustagrip Jaw External Clamping	Adjustagrip Jaw Internal Clamping	Adjustagrip Jaw Bar Clamping	Hard Reversible Jaw
	Page	Page	Page	Page
BERG	114	114	114	124-125
FORKARDT	115	115	115	124-125
GAMET				124-125
KITAGAWA				124-125
RÖHM	116	116	116	124-125
SAMCHULLY	117	117	117	124-125
SCHUNK	118-120	118-120	118-120	124-125
SMW-AUTOBLOK	121-123	121-123	121-123	124-125

Adjustagrip Hard Top Jaws

For Slot/Tenon Quick Jaw Change Chucks

Material:

- Steel, 590M17
- Black Finish

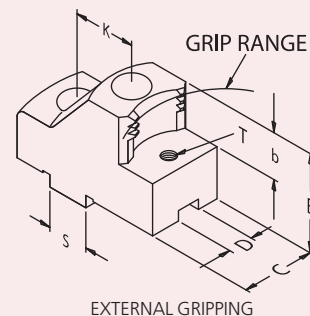

To suit • Berg Chuck Series KHNC

CHUCK Ø	TYPE	GRIPPING RANGES	BASE JAW POS.	MAX Ø SWING	THAME PART No.	B	C	D	K	S	b	T	WEIGHT Kg/Set
160	KHNC 160	27 - 62	1	212	LY 10	49	30	8	32	18	20	M6	1.3
		47 - 90	2	241									1.1
		81 - 125	1	212	LY 14								1.1
		110 - 154	2	241									1.4
		124 - 168	1	212	LY 17								1.4
200	KHNC 200	27 - 65	1	250	LY 20	49	30	10	40	20	20	M6	1.3
		65 - 118	2	303									1.2
		46 - 97	1	250	LY 22								1.2
		97 - 150	2	303									1.2
		81 - 133	1	250	LY 25								1.2
250	KHNC 250	33 - 100	1	320	LY 30	59	40	12	40	20	25	M6	2.4
		93 - 172	2	392									2.3
		60 - 137	1	320	LY 32								2.3
		130 - 209	2	392									2.0
		111 - 190	1	320	LY 35								2.0
315	KHNC 315	33 - 172	1	392	LY 30	59	40	12	40	20	25	M6	2.4
		93 - 243	2	404									2.3
		61 - 209	1	392	LY 32								2.3
		130 - 281	2	404									2.0
		112 - 263	1	392	LY 35								2.0
400	KHNC 400	51 - 215	1	469	LY 40	59	50	12	54	26	25	M8	4.0
		102 - 290	2	545									3.2
		152 - 342	1	469	LY 43								3.2
		227 - 417	2	545									

Slot/Tenon Hard Top Jaws

BASE JAW POSITION

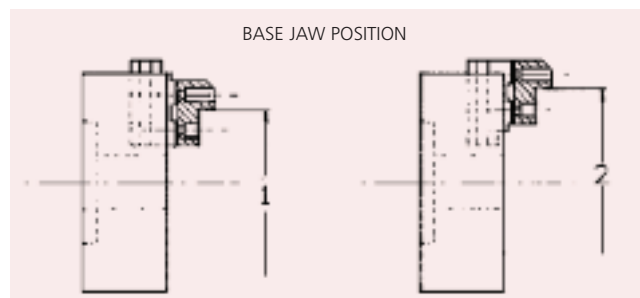

Workpiece Height Pins

See page 165



Adjustagrip Hard Top Jaws

For Slot/Tenon Quick Jaw Change Chucks

Material:

- Steel, 590M17
- Black Finish

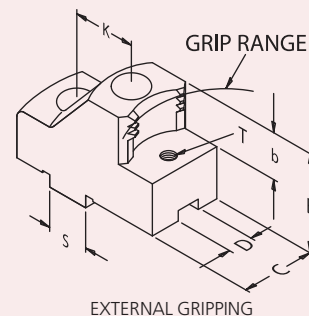

To suit • Forkardt Chuck Series FNC

CHUCK Ø	TYPE	GRIPPING RANGES	BASE JAW POS.	MAX Ø SWING	THAME PART No.	B	C	D	K	S	b	T	WEIGHT Kg/Set	
175	FNC 175	28 - 70	1	220	LY 10	49	30	8	32	18	20	M6	1.3	
		60 - 105	2	221										
		88 - 134	1	220	LY 14									
		124 - 169	2	221										
		131 - 177	1	220	LY 17									
		167 - 213	2	251										
200	FNC 200	27 - 31	1	262	LY 20	49	30	10	40	20	20	M6	1.3	
		60 - 125	2	262										
		46 - 52	1	262	LY 22									
		92 - 157	2	262										
		81 - 146	1	262	LY 25									
		128 - 193	2	262										
250	FNC 250	33 - 112	1	332	LY 30	59	40	12	40	20	25	M6	2.4	
		92 - 183	2	332										
		59 - 149	1	332	LY 32									
		129 - 221	2	332										
		111 - 202	1	332	LY 35									
		182 - 274	2	332										
315	FNC 315	36 - 147	1	368	LY 30	59	40	12	40	20	25	M6	2.4	
		92 - 219	2	368										
		59 - 185	1	368	LY 32									
		129 - 257	2	368										
		111 - 238	1	368	LY 35									
		182 - 310	2	368										
400	FNC 400	51 - 179	1	433	LY 40	59	50	12	54	26	25	M8	4.0	
		107 - 256	2	436										
		156 - 305	1	433	LY 43									
		233 - 383	2	436										

Slot/Tenon Hard Top Jaws

BASE JAW POSITION

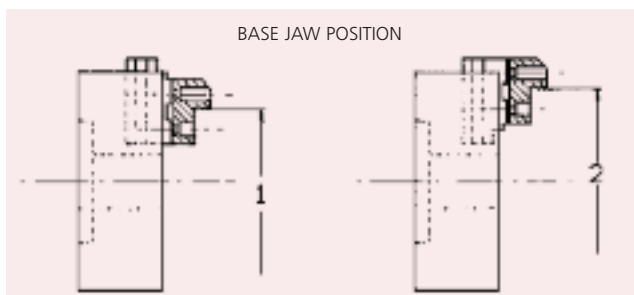

Workpiece Height Pins

See page 165



Internal and bar gripping jaws available on request.

Adjustagrip Hard Top Jaws

For Slot/Tenon Quick Jaw Change Chucks

Material:

- Steel, 590M17
- Black Finish

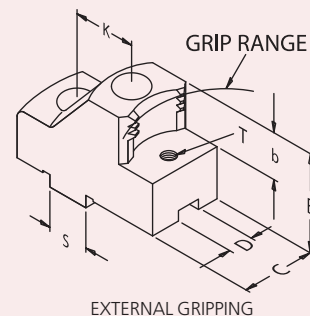

To suit • Röhm Chuck Series Duro-NC

CHUCK Ø	TYPE	GRIPPING RANGES	BASE JAW POS.	MAX Ø SWING	THAME PART No.	B	C	D	K	S	b	T	WEIGHT Kg/Set			
160	DURO-NC 160	27 - 59	1	209	LY 10	49	30	8	32	18	20	M6	1.3			
		51 - 95	2	211												
		78 - 123	1	209	LY 14											1.1
		114 - 159	2	211												
		121 - 166	1	209	LY 17											1.4
		157 - 202	2	241												
175	DURO-NC 175	30 - 72	1	223	LY 10	49	30	8	32	18	20	M6	1.3			
		65 - 109	2	226												
		91 - 136	1	223	LY 14											1.1
		128 - 174	2	226												
		134 - 179	1	223	LY 17											1.4
		172 - 217	2	255												
200	DURO-NC 200	30 - 72	1	263	LY 20	49	30	10	40	20	20	M6	1.3			
		65 - 109	2	279												
		91 - 136	1	263	LY 22											1.2
		128 - 174	2	279												
		134 - 179	1	263	LY 25											1.2
		172 - 217	2	279												
250	DURO-NC 250	33 - 113	1	332	LY 30	59	40	12	40	20	25	M6	2.4			
		92 - 196	2	340												
		55 - 150	1	332	LY 32											2.3
		129 - 233	2	340												
		106 - 203	1	332	LY 35											2.0
		182 - 287	2	340												
315	DURO-NC 315	51 - 146	1	400	LY 40	59	50	12	54	26	25	M8	4.0			
		96 - 230	2	410												
		152 - 273	1	400	LY 43											3.2
		221 - 357	2	410												
400	DURO-NC 400	74 - 221	1	528	LY 50	78	50	18	60	30	33	M8	5.6			
		101 - 280	2	588												
		160 - 340	1	528	LY 55											5.1
		208 - 389	2	588												

Internal and bar gripping jaws available on request.

Adjustagrip Hard Top Jaws

For Slot/Tenon Quick
Jaw Change Chucks

Material:

- Steel, 590M17
- Black Finish

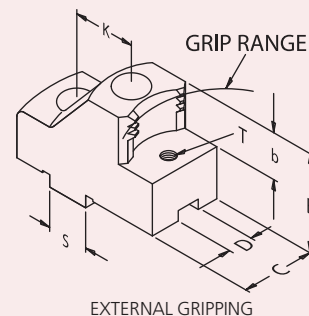

To suit • Samchully Chuck Series QJC

CHUCK Ø	TYPE	GRIPPING RANGES	BASE JAW POS.	MAX Ø SWING	THAME PART No.	B	C	D	K	S	b	T	WEIGHT Kg/Set	
165	QJC-206	44 - 76	1	209	LY 10	49	30	8	32	18	20	M6	1.3	
		61 - 99	2	210										
		76 - 109	1	209	LY 13									
		93 - 127	2	209										
		106 - 140	1	209	LY 14									
		124 - 158	2	209										
215	QJC-208	39 - 110	1	285	LY 20	49	30	10	40	20	20	M6	1.3	
		75 - 147	2	285										
		101 - 174	1	285	LY 24									
		131 - 211	2	285										
260	QJC-210	63 - 124	1	332	LY 30	59	40	12	40	20	25	M6	2.4	
		125 - 188	2	332										
		152 - 215	1	332	LY 35									
315	QJC-212	67 - 150	1	380	LY 30	59	40	12	40	20	25	M6	2.4	
		151 - 235	2	380										
		156 - 241	1	380	LY 35									
		242 - 327	2	380										
400	QJC-215	78 - 193	1	447	LY 40	59	40	12	54	26	25	M8	4.0	
		153 - 270	2	450										
		202 - 320	1	447	LY 43									
		279 - 397	2	450										

Slot/Tenon Hard Top Jaws

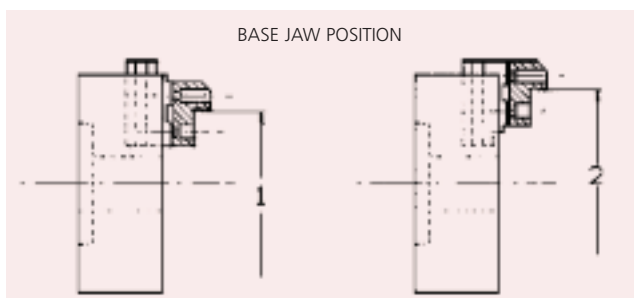

Workpiece Height Pins



See page 165

Internal and bar gripping jaws and different diameter ranges available on request.

Adjustagrip Hard Top Jaws

For Slot/Tenon Quick Jaw Change Chucks

Material:

- Steel, 590M17
- Black Finish

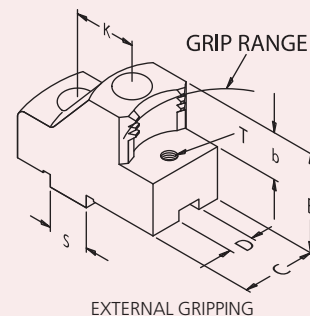

To suit • Schunk Chuck Series Rota THW

CHUCK Ø	TYPE	GRIPPING RANGES	BASE JAW POS.	MAX Ø SWING	THAME PART No.	B	C	D	K	S	b	T	WEIGHT Kg/Set
165	THW 165	29 - 50	1	182	LY 10	49	30	8	32	18	20	M6	1.3
		37 - 67	2	200									
		51 - 82	1	182	LY 13								1.2
		68 - 100	2	200									
		81 - 113	1	182	LY 14								1.1
		98 - 131	2	200									
210	THW 210	27 - 73	1	247	LY 20	49	30	10	40	20	20	M6	1.3
		58 - 110	2	285									
		53 - 105	1	247	LY 22								1.2
		90 - 142	2	285									
		88 - 141	1	247	LY 25								1.2
		126 - 179	2	285									
250	THW 250	33 - 88	1	296	LY 30	59	40	12	40	20	25	M6	2.4
		91 - 151	2	360									
		66 - 126	1	296	LY 32								2.3
		128 - 189	2	360									
		117 - 178	1	296	LY 35								2.0
		181 - 242	2	360									
265	THW 265	33 - 99	1	307	LY 30	59	40	12	40	20	25	M6	2.4
		91 - 162	2	371									
		66 - 136	1	307	LY 32								2.3
		128 - 200	2	371									
		117 - 189	1	307	LY 35								2.0
		181 - 253	2	371									
315	THW 315	36 - 115	1	345	LY 30	59	40	12	40	20	25	M6	2.4
		119 - 202	2	433									
		71 - 152	1	345	LY 32								2.3
		157 - 240	2	433									
		122 - 205	1	345	LY 35								2.0
		210 - 293	2	433									
400	THW 400	55 - 166	1	420	LY 40	59	50	12	54	26	25	M8	4.0
		117 - 243	2	498									
		166 - 292	1	420	LY 43								3.2
		243 - 370	2	498									

Internal and bar gripping jaws available on request.

Adjustagrip Hard Top Jaws

For Slot/Tenon Quick Jaw Change Chucks

Material:

- Steel, 590M17
- Black Finish

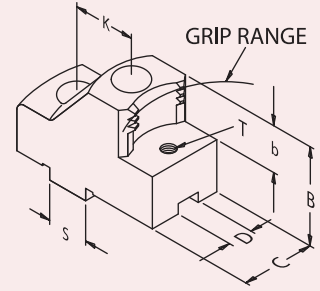

EXTERNAL GRIPPING

To suit • Schunk Chuck Series Rota G

CHUCK Ø	TYPE	GRIPPING RANGES	BASE JAW POS.	MAX Ø SWING	THAME PART No.	B	C	D	K	S	b	T	WEIGHT Kg/Set			
160	ROTA G 160	27 - 73	1	190	LY 10	49	30	8	32	18	20	M6	1.3			
		40 - 91	2	242												
		84 - 137	1	190	LY 14											1.1
		102 - 155	2	242												
		127 - 180	1	219	LY 17											1.4
		145 - 198	2	242												
200	ROTA G 200	30 - 100	1	236	LY 20	49	30	10	40	20	20	M6	1.3			
		66 - 137	2	322												
		61 - 132	1	236	LY 22											1.2
		97 - 169	2	322												
		134 - 206	2	322	LY 25								1.2			
250	ROTA G 250	33 - 121	1	264	LY 30	59	40	12	40	20	25	M6	2.4			
		90 - 184	2	404												
		65 - 158	1	266	LY 31											2.4
		127 - 221	2	404												
		117 - 211	1	264	LY 35											2.0
		180 - 274	2	404												
315	ROTA G 315	52 - 131	1	315	LY 40	59	50	12	54	26	25	M8	4.0			
		100 - 216	2	455												
		152 - 257	1	315	LY 43											3.2
		225 - 343	2	455												
400	ROTA G 400	68 - 186	1	400	LY 40	59	50	12	54	26	25	M8	4.0			
		142 - 263	2	519												
		192 - 313	1	400	LY43											3.2
		269 - 391	2	519												

Slot/Tenon Hard Top Jaws

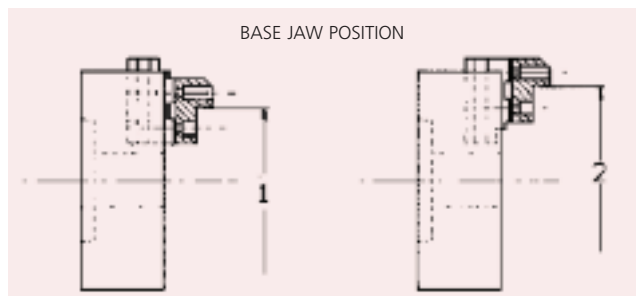

Workpiece Height Pins



See page 165

Internal and bar gripping jaws available on request.

Adjustagrip Hard Top Jaws

For Slot/Tenon Quick Jaw Change Chucks

Material:

- Steel, 590M17
- Black Finish

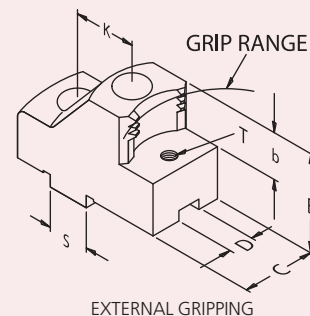

To suit • Schunk Chuck Series Rota S

CHUCK Ø	TYPE	GRIPPING RANGES	BASE JAW POS.	MAX Ø SWING	THAME PART No.	B	C	D	K	S	b	T	WEIGHT Kg/Set	
160	ROTA S 160	27 - 29	1	180	LY 10	49	30	8	32	18	20	M6	1.3	
		46 - 98	2	250										
		73 - 127	1	180	LY 14									
		109 - 163	2	250										
		116 - 170	1	209	LY 17									
		152 - 206	2	250										
200	ROTA S 200	28 - 80	1	216	LY 20	49	30	10	40	20	20	M6	1.3	
		64 - 127	2	312										
		49 - 112	1	216	LY 22									
		96 - 159	2	312										
		84 - 148	1	216	LY 25									
		132 - 196	2	312										
250	ROTA S 250	33 - 101	1	250	LY 30	59	40	12	40	20	25	M6	2.4	
		97 - 176	2	396										
		61 - 138	1	250	LY 32									
		135 - 213	2	396										
		112 - 191	1	250	LY 35									
		187 - 267	2	396										
315	ROTA S 315	54 - 142	1	322	LY 40	59	50	12	54	26	25	M8	4.0	
		100 - 219	2	458										
		152 - 269	1	322	LY 43									
		225 - 347	2	458										
400	ROTA S 400	74 - 195	1	499	LY 50	78	50	18	60	30	33	M8	5.6	
		167 - 314	2	505										
		168 - 314	1	499	LY 55									
		286 - 433	2	515										
500	ROTA S 500	89 - 266	1	588	LY 50	78	50	18	60	30	33	M8	5.6	
		198 - 396	2	588										
		205 - 402	1	588	LY 55									
		317 - 515	2	597										

Internal and bar gripping jaws available on request.

Adjustagrip Hard Top Jaws

For Slot/Tenon Quick Jaw Change Chucks

Material:

- Steel, 590M17
- Black Finish

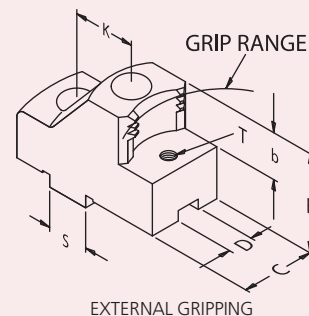

To suit • SMW-Autoblok Chuck Series KNCS-N

CHUCK Ø	TYPE	GRIPPING RANGES	BASE JAW POS.	MAX Ø SWING	THAME PART No.	B	C	D	K	S	b	T	WEIGHT Kg/Set	
170	KNCS-N 170-43	29 - 60	1	191	LY 10	49	30	8	32	18	20	M6	1.3	
		45 - 77	2	209										
		60 - 92	1	191	LY 13									
		77 - 109	2	209										
		90 - 123	1	191	LY 14									
		108 - 141	2	209										
210	KNCS-N 210-52	27 - 91	1	266	LY 20	49	30	10	40	20	20	M6	1.3	
		58 - 128	2	303										
		89 - 160	2	266	LY 22									
		125 - 197	2	303	LY 24									
225	KNCS-N 225-65	27 - 92	1	267	LY 20	49	30	10	40	20	20	M6	1.3	
		59 - 130	2	305										
		91 - 162	2	305	LY 22									
		127 - 198	2	305	LY 25									
260	KNCS-N 260-72	33 - 105	1	313	LY 30	59	40	12	40	20	25	M6	2.4	
		86 - 168	2	377										
		61 - 143	1	313	LY 32									
		123 - 206	2	377										
		112 - 195	1	313	LY 35									
315	KNCS-N 315-91	46 - 126	1	356	LY 30	59	40	12	40	20	25	M6	2.4	
		130 - 213	2	444										
		81 - 163	1	356	LY 32									
		167 - 251	2	444										
400	KNCS-N 400-128	67 - 191	1	446	LY 40	59	50	12	54	26	25	M8	4.0	
		143 - 269	2	525										
		191 - 318	1	446	LY 43									
		269 - 397	2	525										
500	KNCS-N 500-155	74 - 235	1	543	LY 50	78	50	18	60	30	33	M8	5.6	
		180 - 357	2	545										
		177 - 354	1	543	LY 55									
		298 - 475	2	585										

Slot/Tenon Hard Top Jaws

Internal and bar gripping jaws available on request.

Adjustagrip Hard Top Jaws

For Slot/Tenon Quick Jaw Change Chucks

Material:

- Steel, 590M17
- Black Finish

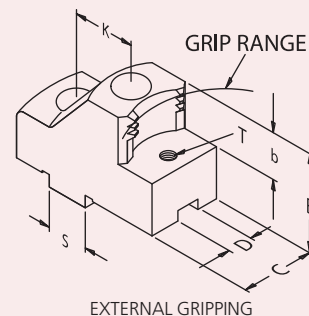

To suit • SMW-Autoblok Chuck Series KNCS

CHUCK Ø	TYPE	GRIPPING RANGES	BASE JAW POS.	MAX Ø SWING	THAME PART No.	B	C	D	K	S	b	T	WEIGHT Kg/Set
160	KNCS 160-32	27 - 46	1	177	LY 10	49	30	8	32	18	20	M6	1.3
		34 - 63	2	195									
		57 - 78	1	177	LY 13								1.2
		65 - 96	2	195									
		78 - 109	1	177	LY 14								1.1
		96 - 127	2	195									
170	KNCS 170-40	27 - 54	1	186	LY 10	49	30	8	32	18	20	M6	1.3
		40 - 72	2	204									
		54 - 87	1	186	LY 13								1.2
		72 - 104	2	204									
		85 - 118	1	186	LY 14								1.1
		102 - 135	2	204									
200	KNCS 200-41	27 - 61	1	235	LY 20	49	30	10	40	20	20	M6	1.3
		56 - 98	2	273									
		51 - 93	1	235	LY 22								1.2
		88 - 130	2	273									
		86 - 129	1	235	LY 25								1.1
		124 - 167	2	273									
250	KNCS 250-52	33 - 84	1	291	LY 30	59	40	12	40	20	25	M6	2.4
		86 - 147	2	355									
		61 - 121	1	291	LY 32								2.3
		123 - 184	2	355									
		113 - 174	1	291	LY 35								2.0
		176 - 237	2	355									

Slot/Tenon Hard Top Jaws

BASE JAW POSITION

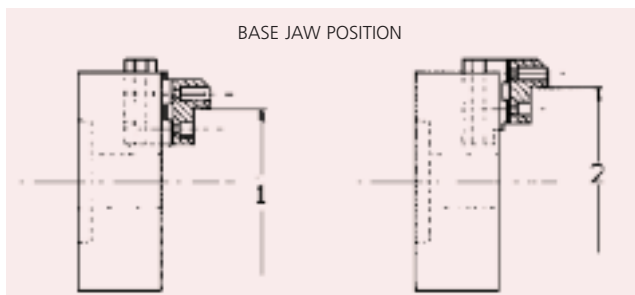

Workpiece Height Pins

See page 165



Internal and bar gripping jaws available on request.

Adjustagrip Hard Top Jaws

For Slot/Tenon Quick Jaw Change Chucks

Material:

- Steel, 590M17
- Black Finish

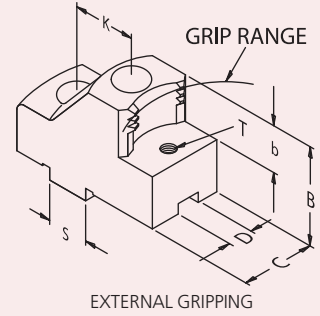

To suit • SMW-Autoblok Chuck Series KNCS continued

CHUCK Ø	TYPE	GRIPPING RANGES	BASE JAW POS.	MAX Ø SWING	THAME PART No.	B	C	D	K	S	b	T	WEIGHT Kg/Set
260	KNCS 260-65	33 - 95	1	302	LY 30	59	40	12	40	20	25	M6	2.4
		86 - 158	2	366									
		61 - 132	1	302	LY 32								2.3
		123 - 195	2	366									
		113 - 185	1	302	LY 35								2.0
		176 - 248	2	366									
315	KNCS 315-77	36 - 115	1	344	LY 30	59	40	12	40	20	25	M6	2.4
		119 - 202	2	432									
		70 - 152	1	344	LY 32								2.3
		156 - 239	2	432									
		122 - 205	1	344	LY 35								2.0
		209 - 293	2	432									
315	KNCS 315-91	46 - 126	1	356	LY 30	59	40	12	40	20	25	M6	2.4
		130 - 213	2	444									
		82 - 164	1	356	LY 32								2.3
		168 - 251	2	444									
		134 - 217	1	356	LY 35								2.0
		221 - 304	2	444									
400	KNCS 400-92	51 - 165	1	419	LY 40	59	50	12	54	26	25	M8	4.0
		116 - 242	2	497									
		165 - 292	1	419	LY 43								3.2
		242 - 369	2	497									
500	KNCS 500-128	74 - 208	1	515	LY 50	78	50	18	60	30	33	M8	5.6
		178 - 327	2	515									
		177 - 326	1	515	LY 55								5.1
		296 - 445	2	555									

Slot/Tenon Hard Top Jaws

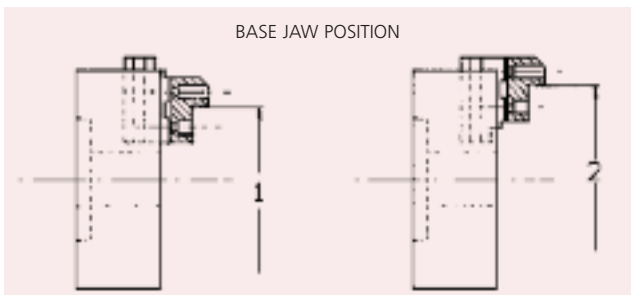

Slot/Tenon Hard Top Jaws

Hard Reversible Jaws For Quick Change Chucks

Material:

- Steel, 590M17
- Black Finish

Chuck Ø 152mm - 800mm

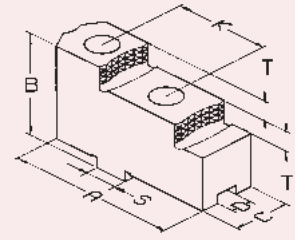

Slot/Tenon Hard Top Jaws

PART No.	A	B	C	D	K	S	T	BOLT TYPE	WEIGHT Kg/Set
GX 16	63	36.5	20	8	32	18	7.5	M8	0.6
GX 20	72	42.0	22	10	40	20	10	M8	0.8
GX 25	90	55	30	12	40	20	14	M12	1.9
GX 32	105	62	36	12	54	26	15	M12	3.2
GX40	130	80	45	18	60	30	20	M16	10.8

BERG	FORKARDT	GAMET	KITAGAWA	RÖHM	SAMCHULLY	SCHUNK	SMW-AUTOBLOK
KHNC 160 KHNC 185	F160 KTNC 160 KTNCV 175 KTNCV 160 FNC 175 F+160	MX 152 MX 175	QJ306	DURO 160 DURO NC 160 DURO NCE 160 DURO NC 175 DURO NCE 175 DURO NCES 175	QJC-206	ROTA-G 160 ROTA-S 160 ROTA-S plus 160 ROTA NC-W 185 THW 165R ROTA THW 165 ROTA NCR 200 ROTA THW plus 165 ROTA THW plus 185	RMG 160 HG 160 HG-F 160 HG-N 160 KNSP 160 KNCS 160 KNCS 175 KNC 160 KNCS 170-43 KNCS -N 170-43
KHNC 200	F 200 KTNC 200 KTNCV 200 FNC 200 F+200	MX215	QJ308	DURO 200 DURO NC 200 DURO NCE 200 DURO NC 225 DURO NCES 200	QJC-208	ROTA-G 200 ROTA-S 200 ROTA-S plus 200 ROTA NC-WF210 ROTA NC-W 225 THW 210 F THW210R ROTA THW plus 215 ROTA THWB 210 ROTA THW vario 215	RMG 200 HG-F210 HG 200 HG-N210 KNSP 200 KNCS 200 KNCS 225 KNCS 210-52 KNCS-N 210-52 KNCS-N 225-65 KNCS-NB 210
KHNC 250 KHNC 315	F 250 KTNC 250 KTNC 280 KTNC 315 KTNCV 250 KTNCV 315 UNC 250/315 FNC 250/315 F+250	MX 252 MX315 MX 330	QJ310 QJ312	DURO 250 DURO NC 250 DURO NCE 250 DURO NCES 250 DURO NCES 315	QJC-210 QJC-212	ROTA-G 250 ROTA NC-WF 25C ROTA-S 250 ROTA-S plus 250 ROTA NC-W 265 ROTAG315 ROTA NC-W 315 ROTA NC-WF 315 THW 250F THW 250R THW 265F THW 265R THW 315R ROTA THW 250 -315 ROTA THW plus 260-315 ROTA THWB 265	RMG 250 KNCS 250 KNCS 260 KNCS 315 KNCS 260-71 KNCS 315-91 KNCS-N 260-72 KNCS-N 315-91 HG 250/315 HG-F 260/315 HG-N 260/315 KNCS-NB 260 KNCS-NB 315
KHNC 400	F 315 KTNC 360 KTNC 400 KTNCV 400 UNC 400 FNC 400 F+315	MX 380	QJ15	DURO 315 DURO NC 315 DURO NCE 400 DURO NCES 315 DURO NCES 400	QJC-215	ROTA-G 400 ROTA-S315 ROTA-S plus 315 ROTA NC-W 400 THW 315F THW 400F THW 400R ROTA THWB 315	RMG-315 KNCS 400 KNCS 400-120 KNCS-N 400-128 HG 400 KNC 400 HG-N400 HG-F 315 KNCS-NB 400
KHNC 500	F 400/500 L UNC 500 KTNC 500 KTNC 630 KTNCV 500 KTNCV 630 FNC 500/630 F+400		QJ21 QJ24	DURO 400 DURO NC 400 DURO 500 DURO NC 500 DURO NCE 500		ROTA-S 400 ROTA-S plus 400 ROTA-G 500 ROTA-S 500 ROTA-S plus 500 THW 500F THW 500R THW 630R ROTA THW 500-630-800 ROTA THWB 400-500	HG 500 HG 630 HG-F 400/500 HG-N 500/600 KNCS 500 KNCS 630 KNCS 500-160 KNCS 630-160 KNCS-N 500-165 KNCS-N 630-165 KNCS 800-160 KNCS-NB 500-630-800

For special size Adjustagrip Jaws and for Chuck types not listed

If the standard listed type is not suitable please fill in the drawing details below and return to us for a quotation.

Slot/Tenon Hard Top Jaws

External Gripping

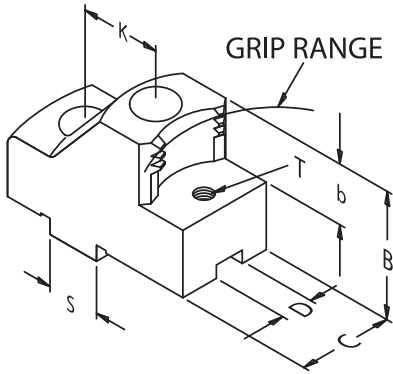

Chuck make and type:

B	
C	
D	
K	
S	
b	
GRIP RANGE	

Internal Gripping

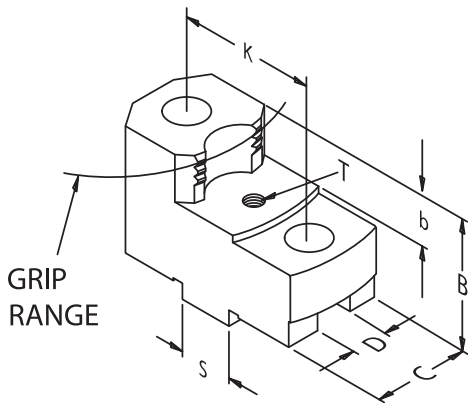

Chuck make and type:

B	
C	
D	
K	
S	
b	
GRIP RANGE	

Bar Gripping

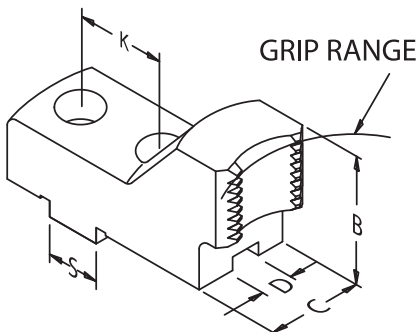

Chuck make and type:

B	
C	
D	
K	
S	
GRIP RANGE	

Scroll Jaws
Soft & Hard

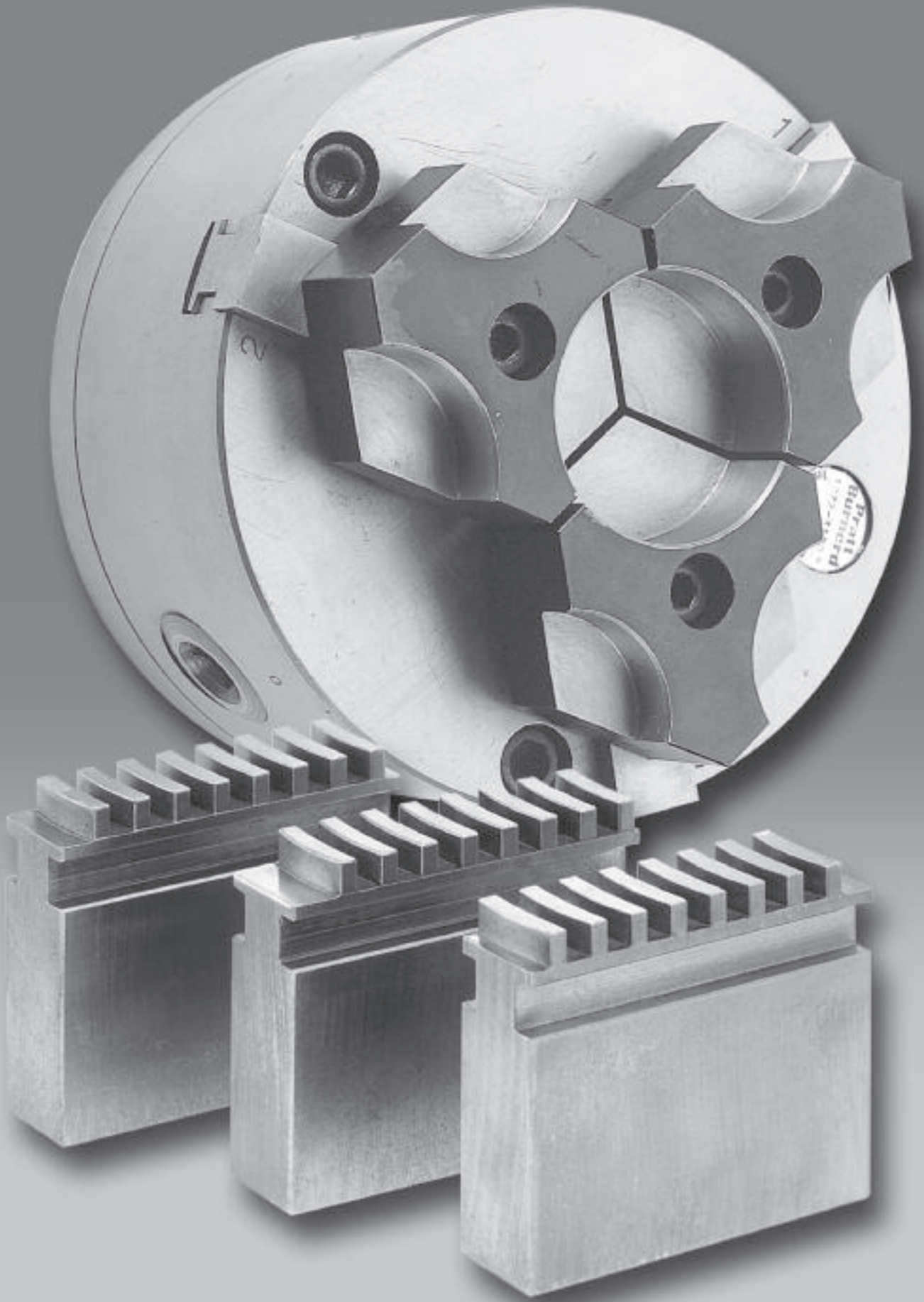

Scroll Jaws Soft & Hard

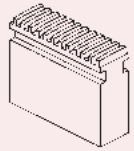

Soft Scroll Jaws

- For manual chucks

Page

130 - 132

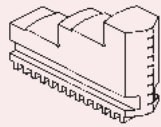

Hard Inside Jaws

- For manual chucks

130 - 132

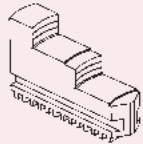

Hard Outside Jaws

- For manual chucks

130 - 132

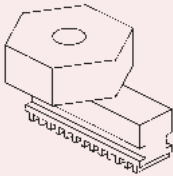

Indexahex System

- For manual chucks

133

	Soft Scroll Jaws	Hard Inside Jaws	Hard Outside Jaws	Indexahex System
	Page	Page	Page	Page
EMCO	131			
PRATT BURNERD	130, 132	130, 132	130, 132	133
RÖHM	131	131	131	
RÖHM	131	131	131	
SAMCHULLY	131	131	131	
T de G	131	131	131	
TOOLMEX-BISON	130	130	130	133

Scroll Jaws Soft and Hard

For Manual Scroll Chucks

Material: Steel

- Soft Jaws 080M15

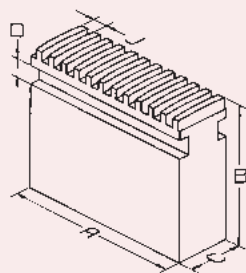

SOFT

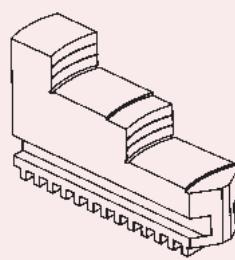

HARD OUTSIDE

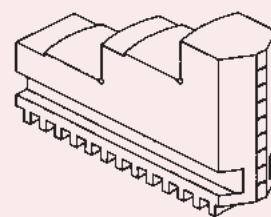

HARD INSIDE

To suit • Bison & Toolmex 3500, 3700 Scroll Chucks

CHUCK Ø	A	B	C	D	J	WEIGHT Kg/Set	THAME PART No.		
							SOFT JAWS	HARD INSIDE JAWS	HARD OUTSIDE JAWS
80	32	35	11	6	4	0.3	EN08		
100	42	35	15	6	6	0.5	EN10		
125	51	38	20	8	7	0.8	EN 13		
160	70	51	20	8	8	1.3	EN 16		
200	85	57	25	10	8	2.5	EN 20		
250	105	70	28	12	9	4.2	EN 25		
315	127	76	32	12	10	6.3	EN32		
400	145	90	36	14	12	9.0	EN40		

AVAILABLE ON REQUEST

To suit • Pratt Burnerd Standard & Super Precision Metric Scroll Chucks

CHUCK Ø	A	B	C	D	J	WEIGHT Kg/Set	THAME PART No.		
							SOFT JAWS	HARD INSIDE JAWS	HARD OUTSIDE JAWS
80	37	40	10	5	6	0.3	EK 08	EF 08	EG08
100	42	35	14	7	6	0.4	EK 10	EF 10	EG 10
125	53	38	16	7	6	0.7	EK 13	EF 13	EG 13
160	68	45	18	7	6	1.2	EK 16	EF 16	EG 16
200	78	50	22	8	8	2.0	EK 20	EF 20	EG20
250	100	70	25	8	8	3.8	EK 25	EF 25	EG25
315	124	75	32	12	10	6.3	EK 32	EF 32	EG32
400	154	89	32	12	12	9.5	EK 40	EF 40	EG40
500	190	100	42	15	12	18.7	EK50	EF50	EG50

To suit • Pratt All Steel (Type 78) 3 & 4 Jaw Chucks

CHUCK Ø	A	B	C	D	J	WEIGHT Kg/Set	THAME PART No.		
							SOFT JAWS	HARD INSIDE JAWS	HARD OUTSIDE JAWS
230	89	70	25.40	9.52	8.46	3.4	ELL		NOT AVAILABLE
310	108	76	30.15	11.43	8.46	5.3	ELO		AVAILABLE

For 80, 100, 160, 190, 270 & 400mm Chucks please use range above which are interchangeable.

Scroll Jaws Soft and Hard

For Manual Scroll Chucks

- Material: Steel
- Soft Jaws 080M15

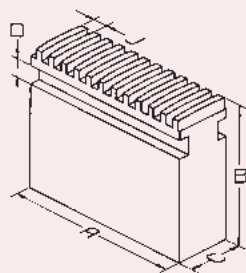

SOFT

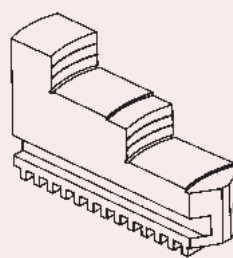

HARD OUTSIDE

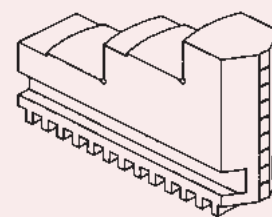

HARD INSIDE

To suit • Emco Forte, Super & Ultra Scroll Chucks

CHUCK Ø	A	B	C	D	J	WEIGHT Kg/Set	THAME PART No.		
							SOFT JAWS	HARD INSIDE JAWS	HARD OUTSIDE JAWS
160	66	51	19.8	8.4	8	1.5	EP 16	NOT AVAILABLE	
200/230	82	70	26.0	10.0	8	3.0	EP 20		
250	100	70	25.8	10.4	10	4.0	EP 25		
315/400	120	80	32.0	12.0	10	7.0	EP 32		

To suit • Röhms ZS & ZG Scroll Chucks

CHUCK Ø	A	B	C	D	J	WEIGHT Kg/Set	THAME PART No.		
							SOFT JAWS	HARD INSIDE JAWS	HARD OUTSIDE JAWS
125	52	40	18	7	6	0.9	EH12	AVAILABLE ON REQUEST	
140/160	61	51	18	7	8	1.1	EH 16		
200	69	57	20	8	8	1.6	EH 20		
250	90	70	24	10	10	3.0	EH 25		
315/350/400	130	76	34	15	10	7.2	EH 32		

To suit • Samchully Scroll Chucks

CHUCK Ø	A	B	C	D	J	WEIGHT Kg/Set	THAME PART No.		
							SOFT JAWS	HARD INSIDE JAWS	HARD OUTSIDE JAWS
165	65	50.8	19	8.17	7.26	1.4	EB 16	AVAILABLE ON REQUEST	
190	75	65	22	9.74	8.46	2.3	EB 16		
230	85	64.7	24	11.4	8.46	2.8	EB 23		
270	100	70	28	11.4	8.46	4.0	EB 27		
310	110	80	30	16.14	10.16	5.8	EB 31		

To suit • T De G Scroll Chucks

CHUCK Ø	A	B	C	D	J	WEIGHT Kg/Set	THAME PART No.		
							SOFT JAWS	HARD INSIDE JAWS	HARD OUTSIDE JAWS
85	34	25	12	5.0	4	0.3	FS 08	AVAILABLE ON REQUEST	
110	47	32	15	6.5	5	0.4	FS 10		
135	56	45	18	8.0	6	1.0	FS 14		
160	67	51	22	9.0	7	1.4	FS 16		
200	77	57	25	10.5	8	2.6	FS 20		
250	95	64	32	12.5	10	4.6	FS 25		
315	115	76	40	14.0	12	8.2	FS 32		
400	140	89	40	14.0	12	11.8	FS 40		

Scroll Jaws
Soft & Hard

Scroll Jaws Soft and Hard

For Manual Scroll Chucks

Material: Steel

- Soft Jaws 080M15

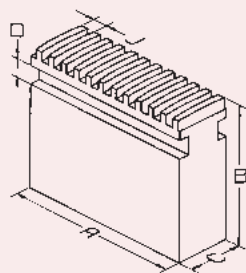

SOFT

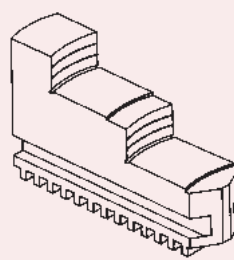

HARD OUTSIDE

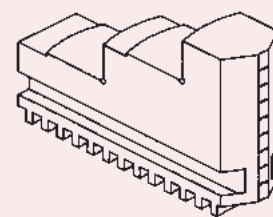

HARD INSIDE

To suit • Pratt Burnerd Standard, Super Precision & Griptru Imperial Scroll Chucks

CHUCK Ø	A	B	C	D	J	WEIGHT Kg/Set	THAME PART No.		
							SOFT JAWS	HARD INSIDE JAWS	HARD OUTSIDE JAWS
80	32	32	9.40	4.85	4.24	0.2	EJB		
100	41	35	14.10	4.85	5.08	0.4	EJC		
125	51	40	15.75	8.03	6.35	0.5	EJE		
160	70	44	18.79	8.03	6.35	1.2	EJG		
200	76	57	20.62	9.53	8.46	1.9	EJJ		
250	102	70	25.40	11.10	8.46	3.8	EJM		
315	114	70	28.19	12.88	8.46	4.7	EJP		
380	127	76	30.15	11.43	10.16	6.2	EJQ		
460/535/610	146	90	38.10	14.30	12.70	10.6	EJR		

NOT AVAILABLE
CHUCKS OBSOLETE

To suit • Pratt/Hardinge Chucks

CHUCK Ø	A	B	C	D	J	WEIGHT Kg/Set	THAME PART No.		
							SOFT JAWS	HARD INSIDE JAWS	HARD OUTSIDE JAWS
125	44	35	14.10	4.85	6.35	0.4	ELF		NOT AVAILABLE

To suit • Pratt Old Type Chucks

CHUCK Ø	A	B	C	D	J	WEIGHT Kg/Set	THAME PART No.		
							SOFT JAWS	HARD INSIDE JAWS	HARD OUTSIDE JAWS
150	63	44	18.39	8.03	8.46	1.11	ELH		NOT AVAILABLE

For 190 to 400mm Chucks please use all steel range above which are interchangeable.

To suit • Burnerd Scroll Chucks

CHUCK Ø	A	B	C	D	J	WEIGHT Kg/Set	THAME PART No.		
							SOFT JAWS	HARD INSIDE JAWS	HARD OUTSIDE JAWS
190/200/230	76	57	25.02	9.70	8.46	2.4	ELI		NOT AVAILABLE
270/305	102	76	31.37	12.88	8.46	5.2	ELN		AVAILABLE

For 80, 100, 125 & 160mm Chucks please use standard range above which are interchangeable.

Scroll Jaw Indexahex System

Suitable for Manual Scroll Chucks

Master Base Jaws

Material: Steel

- Soft Jaws 080M15

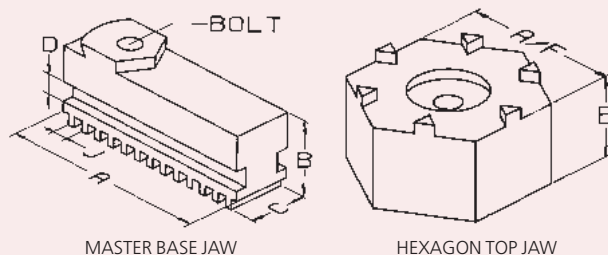

To suit • Pratt Burnerd 3 Jaw Standard & Super Precision Metric Scroll Chucks

PART No.	C	D	J	WEIGHT Kg/Set	CHUCK \varnothing	TAKE HEXAGON TOP JAW TYPE
FR 16	18	7	6	0.8	160	FQ 13
FR 20	22	8	8	1.1	200	FQ20
FR 25	25	8	8	1.7	250	FQ20
FR 32	32	12	10	2.7	315	FQ32

To suit • Bison & Toolmex 3500, 3700 Scroll Chucks

THAME PART No.	C	D	J	WEIGHT Kg/Set	CHUCK \varnothing	TAKE HEXAGON TOP JAW TYPE
FP16	20	8	8	1.0	160	FQ 13
FP20	25	10	8	1.3	200	FQ20
FP25	28	12	9	1.9	250	FQ25
FP32	32	12	10	2.7	315	FQ32

Scroll Jaws
Soft & Hard

To suit • Pratt Burnerd 3 Jaw Standard, Super Precision & Griptru Imperial Scroll Chucks

THAME PART No.	C	D	J	WEIGHT Kg/Set	CHUCK \varnothing	TAKE HEXAGON TOP JAW TYPE
FO 13	15.75	8.03	6.35	0.5	125	FQ 13
FO 16	18.79	8.03	6.35	0.8	160	FQ 16
FO 20	20.62	9.53	8.46	1.0	200	FQ20
FO 25	25.40	11.10	8.46	1.8	250	FQ25
FO 32	28.19	12.88	8.46	2.2	315	FQ32

• Hexagon Top Jaws

THAME PART No.	A/F	B	WEIGHT Kg/Set
FQ 13	40	25	0.8
FQ 16	60	30	1.8
FQ20	60	35	2.0
FQ25	80	40	4.3
FQ32	80	45	5.1

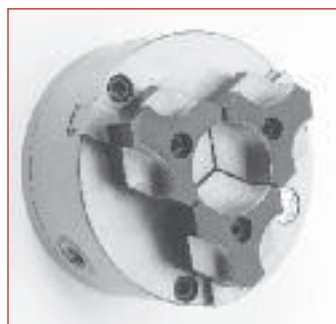

Base Jaws &
Monoblok Jaws

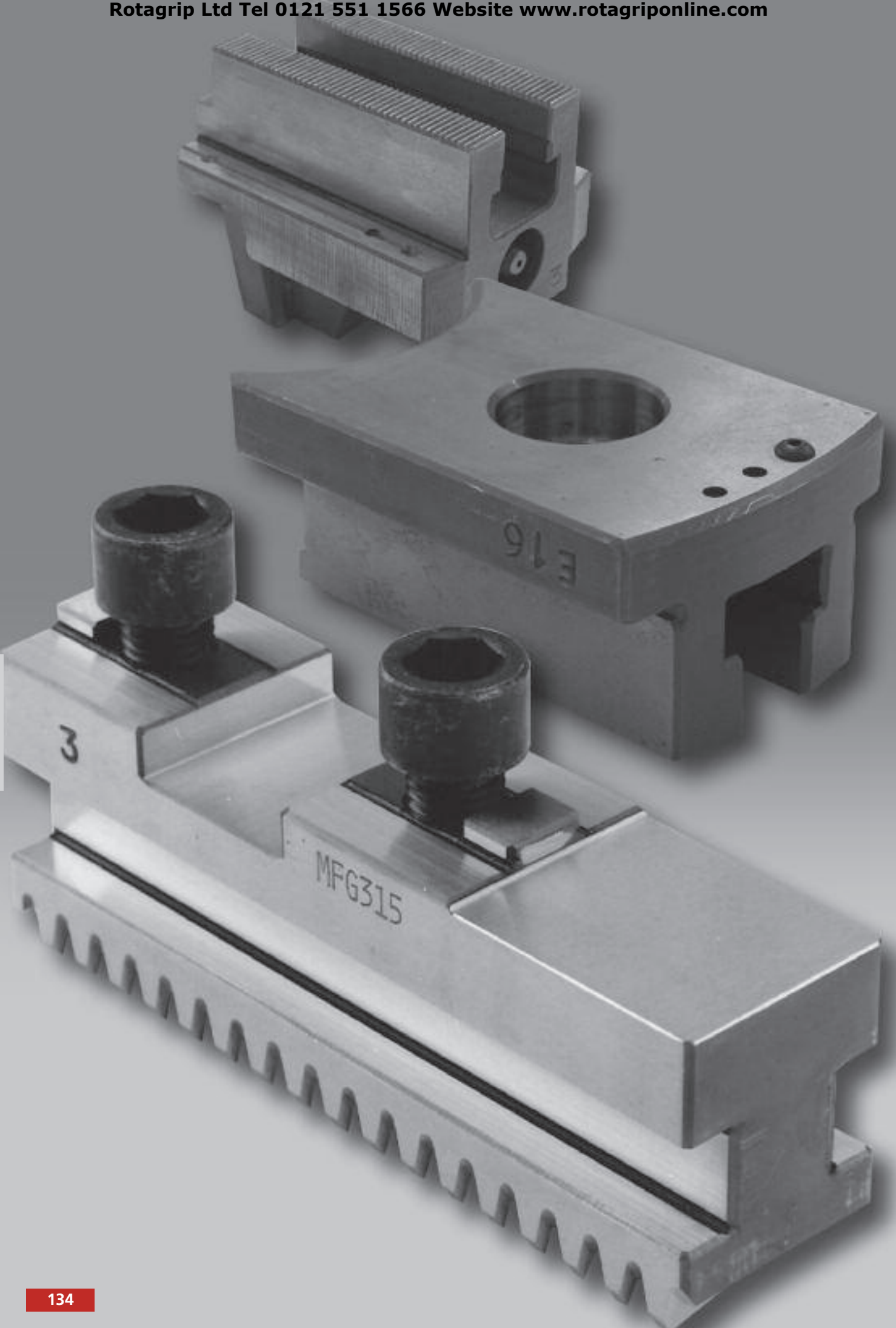

Base Jaws and Monoblok Jaws

Page

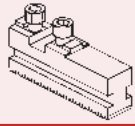

Slot/Tenon Hard Base Jaws

- For quick change jaw chucks

136 - 139



Monoblok Soft Jaws

- For quick jaw change chucks

140 - 141

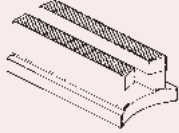

Serrated Base Jaws

- For quick change jaw chucks

141

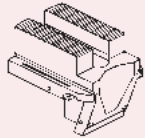

Replacement Base Jaws

- For power chucks

141

Slot/ Tenon Hard Base Jaws

Monoblok Soft Jaws

	Page	Page
FORKARDT	136-137	141
KITAGAWA	138-139	140
RÖHM	136-137	141
SCHUNK	136-137, 138-139	140, 141
SMW	138-139	140, 141
SMW-AUTOBLOK	136-137, 138-139	140

Slot/Tenon Hard Base Jaws

For Quick Jaw Change Chucks

Material:

- Steel:

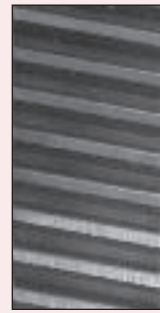
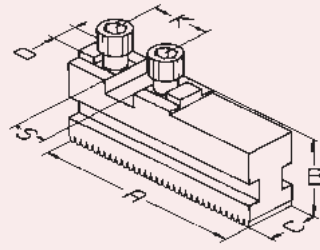

ANGLED TEETH

Chuck Ø 160mm - 630mm

PART No.	A	B	C	D	K	S	BOLT TYPE	WEIGHT Kg/Set
MFG 160	74	29.5	20	8	32	18	M8	0.8
MFG 200	90	35	22	10	40	20	M8	1.2
MFG 250	110	40	26	12	40	20	M12	2.0
MFG 315	125	46	32	12	54	26	M12	3.3
MFG 400	160	55	45	18	60	30	M16	7.3
MFG 630	230	58	65	24	82	40	M20	17.1

Base Jaws & Monoblok Jaws

FORKARDT	SCHUNK	RÖHM	SMW-AUTOBLOK
F160; F+160; FNC 175; KTNCV 175; KTNC 160	Rota S 160 Rota S plus 160	Duro 160 Duro NC 160 Duro NC 175 Duro NCE 160	HG-F 160
F 200; F+200; FNC 200; KTNCV 200; KTNC 200;	THW 210 F Rota S 200 Rota S plus 200 Rota NC-WF 210	Duro 200 Duro NC 200 Duro NCE 200 Duro NC 225	HG-F 210
F 250; F+250; UNC 250/315; KTNC 250; KTNC 280; KTNC 315; KTNCV 250; KTNCV 315; FNC 250/315	THW 250F THW 265F Rota S 250 Rota S plus 250 Rota NC-WF 250 Rota NC-WF 315	Duro 250 Duro NC 250 Duro NCE 250 Duro NCE 315	HG-F 260
F 315; F+315; UNC 400; KTNC 360; KTNC 400; KTNCV 400; FNC 400	THW 315F Rota S 315 Rota S plus 315 THW 400F	Duro 315 Duro NC 315 Duro NCE 400	HG-F 315
F 400; F+400; F 500 L; UNC 500; KTNC 500; KTNC 630; KTNCV 500; KTNCV 630; FNC 500/630	THW 500F Rota S 400 Rota S 500 Rota S plus 400 Rota S plus 500	Duro 400 Duro 500 Duro NC 400 Duro NC 500 Duro NCE 500	HG-F 400 HG-F 500
F 630; F+630	Rota S 630	Duro 630 Duro NC630	HG-F 630

Slot/Tenon Hard Base Jaws

For Quick Jaw Change Chucks

Material:

- Steel:

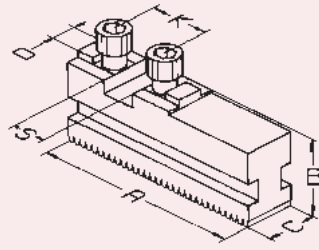

STRAIGHT TEETH

Chuck Ø 140mm - 800mm

PART No.	A	B	C	D	K	S	BOLT TYPE	WEIGHT Kg/Set
GBK 140	56	27.5	20	8	32	18	M8	0.6
GBK 160	65	27.5	20	8	32	18	M8	0.7
GBK 200	85	29.5	22	10	40	20	M8	1.0
GBK 250	104	37	26	12	40	20	M12	1.8
GBK 315	115	43	32	12	40	20	M12	2.7
GBK 400	125	43	32	12	54	26	M12	3.0
GBK 500	160	57	45	18	60	30	M16	7.1
GBK 630	200	57	45	18	60	30	M16	9.0

Base Jaws & Monoblok Jaws

KITAGAWA	SCHUNK	SMW	SMW-AUTOBLOK
QJ306		KNCS 140	KNCS-N 140
	THW 165; ROTA THW plus 165-185; ROTA THW 165; ROTA NCW 185; ROTA-G 160	KNCS 160; KNCS 175; KNSP 160; HG 160; RMG 160	KNCS-N 170 HG-N 160
QJ308	THW 210-R; ROTA THW plus 215; ROTA THW 210; ROTA THW vario 215; ROTA-G 200; ROTA NCW 225	KNCS 200; KNCS 210; KNSP 200; HG 200; RMG 200	KNCS-N 210 KNCS-N 225 HG-N 210
QJ310	THW 250-265-R; ROTA THW plus 260; ROTA THW 250; ROTA-G 250; ROTA NCW 265	KNCS 250; KNCS 260 HG 250; RMG 200	KNCS-N 260 HG-N 260
QJ312	THW 315-R; ROTA THW plus 315; ROTA THW 315; ROTA NCW 315; ROTA-G 315	KNCS 315 HG 315	KNCS-N 315-91 HG-N 315
QJ15	THW 400-R; ROTA THW 400; ROTA-G 400	KNCS 400 HG 400 RMG 315	KNCS-N 400 HG-N 400
QJ21	THW 500-R; ROTA THW 500; ROTA-G 500;	KNCS 500 HG500	KNCS-N 500 HG-N 500
QJ24	THW 630-R; ROTA THW 630; ROTA THW 800	KNCS 630 HG 630	KNCS-N 630 HG-N 630

Monoblok Soft Jaws To Suit Quick Jaw Change Chucks

- Material : 15CrNi6

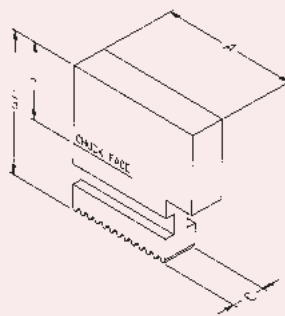

STRAIGHT TEETH

To suit • Kitagawa • SMW-Autoblock • Schunk

PART No.	A	B	C	h	WEIGHT Kg/SET	KITAGAWA	SMW-AUTOBLOK	SCHUNK
UVB 140	58	60	20	39	1.1		KNCS 140 KNCSN 140	
UVB 160	69	60	20	39	1.3	QJ 306	KNCS 160 KNCS 175 KNCSN 170 KNSP 160 RMG 160 HG 160 HGN 160 KNCS-N170	THW 165 R Rota-G 160 Rota NC-W185 ROTA THW plus 165-185 ROTA THW 165
UVB 200	84	70	22	45	2.0	QJ 308	KNCS 200 KNCSN 210 KNCSN 225 KNSP 200 RMG 200 HG 200 HGN 210	THW 210 R Rota-G 200 Rota NC-W225 ROTA THW 210 ROTA THW plus 215 ROTA THW vario 215
UVB 250	107	90	26	61	4.2	QJ310	KNCS 250 KNCS 260 KNCSN 260 RMG 250 HG 250 HGN 260	THW 250 R THW 265 R Rota-G 250 Rota NC-W265 ROTA THW 250 ROTA THW plus 260
UVB 315	118	100	32	66	6.6	QJ312	KNCS 315 KNCSN 315 HG315 HGN 315	THW315 R Rota-G 315 Rota NC-W315 ROTA THW 315 ROTA THW plus 315
UVB 400	145	100	32	66	9.0	QJ15	KNCS 400 KNCSN 400 RMG315 HG 400 HGN 400	THW 400 R Rota-G 400 Rota NC-W400 ROTA THW 400
UVB 500	175	134	45	87	19.5	QJ21	KNCS 500 KNCSN 500 HG 500 HGN 500	THW 500 R Rota-G 500 ROTA THW 500
UVB 600	230	134	45	87	27.5	QJ24	KNCS 630 KNCSN 630 HG 630 HGN 630	THW 630 R ROTA THW 630 ROTA THW 800

Base Jaws & Monoblok Jaws

Monoblok Soft Jaws To Suit Quick Jaw Change Chucks

- Material : 15CrNi6

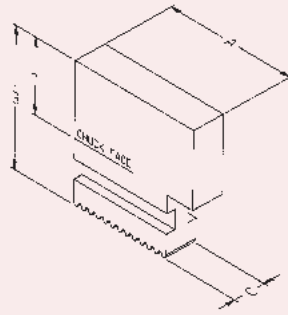

ANGLED TEETH

To suit • Forkardt • Röhm • Schunk • SMW

PART No.	A	B	C	h	WEIGHT Kg/SET	FORKARDT	RÖHM	SCHUNK	SMW
BL 160	79	45	20	24	1.4	F 160 F+ 160 KTNC 160 KTNCV 175 FNC 175	DURO160 DURO-NC 160 DURO-NC 175 DURO-NCE 160	Rota-S 160 Rota-S plus 160	HGF 160
BL 200	94	60	22	35	2.5	F 200 F+200 KTNC 200	DURO 200 DURO-NC 200	THW 210 F Rota-S 200	HGF 210
BL 200 H	94	80	22	55	2.8	KTNCV 200 FNC 200	DURO-NCE 200 DURO-NC 225	Rota-S plus 200 Rota NC-WF 210	
BL 250	115	70	26	40	4.3	F 250 F+250 KTNC 250/280/315 KTNCV 250/315	DURO 250 DURO-NC 250 DURO-NCE 250/315	THW 250-F THW 265-F Rota-S 250	HG-F 260
BL 250 H	115	100	26	70	4.8	UNC 250/315 FNC 250/315		Rota-S plus 250 RotaNC-WF 250 Rota NC-WF 315	
BL 315	140	81	32	46	7.3	F 315 F+315 KTNC 360/400 KTNCV 400	DURO 315 DURO-NC 315 DURO-NCE 400	THW 400 F Rota-S 315 THW315F	HGF 315
BL 315H	140	100	32	100	13.2	UNC 400 FNC 400		Rota-S plus 315	
BL 400	176	93	45	53	15.8	F 400/500L F+400 KTNC 500/630 KTNCV 500/630 UNC 500 FNC 500/630	DURO 400/500 DURO NC 400/500 DURO NCE 500	THW 500 F Rota-S 400 Rota-S 500 Rota-S plus 400 Rota-S plus 500	HGF400 HGF500

Base Jaws &
Monoblok Jaws

Serrated Hard Base Jaws

To suit • Quick Change and other Power Chucks

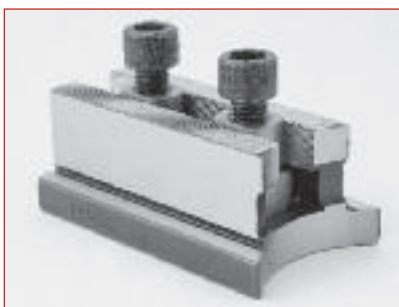

Serrated Quick Change
Base Jaws



Replacement Wedge
Base Jaws

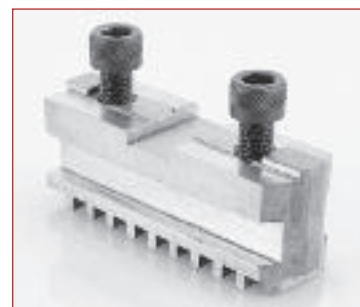

Special Base Jaws

Please contact the Sales Office with details of your chuck.

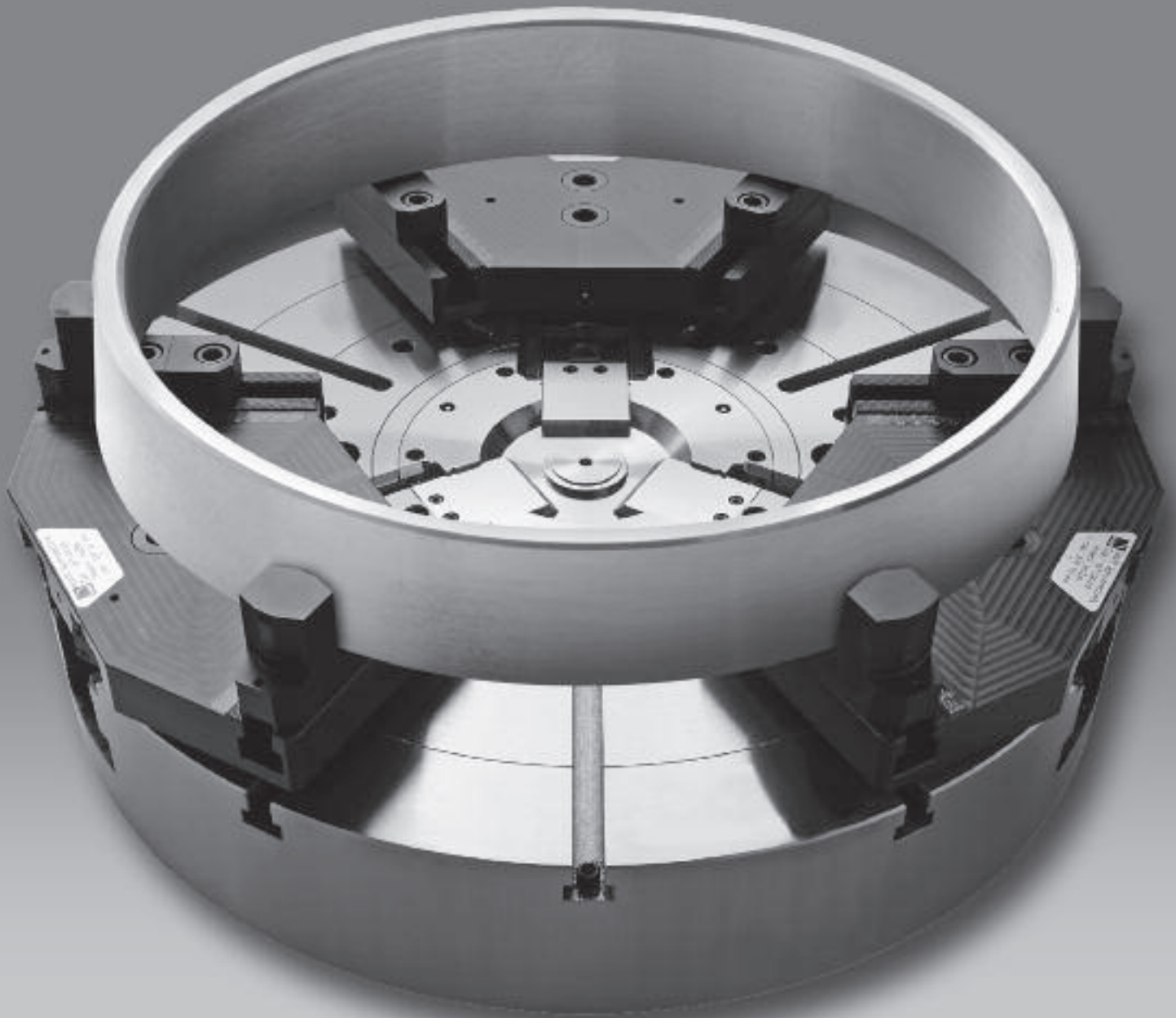

Inogrip
Jaws

Inogrip® Jaws

Page

InoZet®

144

- Concentric compensating 6 point clamping on a 3 jaw chuck

InoTop®

144

- Hybrid chuck jaws for clamping low volume deformation sensitive workpieces

InoGrip®

145

- Jaw clamping process for saving raw material costs and improving out of roundness

InoFlex®

145

- Unbeatable 4 jaw chuck flexibility!

InoZet®

Concentric compensating 6 point clamping on a 3 jaw chuck

The pendulum mechanism permits low-deformation 6 point clamping an unbeatable way to lower distortion using your existing 3 jaw chucks.

- The 3 jaw chuck becomes a compensating 6-jaw chuck
- One set of jaws for the entire clamping range
- Ideal for machining deformation sensitive parts
- Outstanding roundness results
- Simple and easy to work with

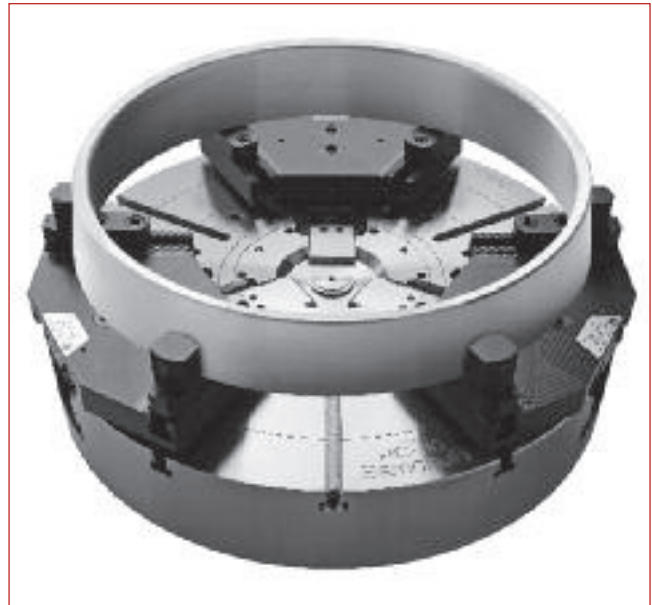
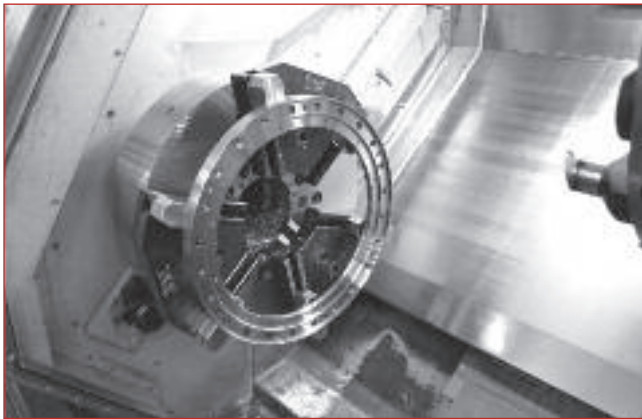

InoTop®

Hybrid chuck jaws for clamping low volume deformation sensitive workpieces

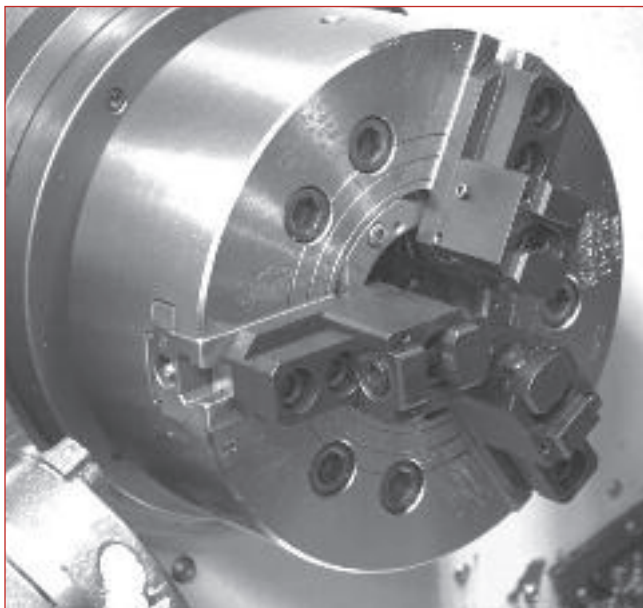

Developed especially to overcome polygon clamping problems. The InoTop® jaws innovative clamping technique is to centre the part from the outside diameter whilst clamping from the inside.

- Workpiece centred without external clamping pressure
- Offers best roundness performance
- Internal clamping jaws close in to hold the part thus avoiding polygon formation
- Ideal for raw workpieces and can be adapted for most standard chucks
- Less deformation of the workpiece due to controlled clamping process



InoGrip®

Jaw clamping process for saving raw material costs and improving out of roundness

InoGrip® jaws secure the workpiece by locking their precise tooth form into identical pre-stamped material offering very secure clamping at low or high pressure.

- Very secure workpiece clamping due to locking clamping teeth allows higher cutting speeds
- Low distortion as less clamping pressure is needed to hold the workpiece
- One set of jaws for both roughing (high pressure) and finishing (low pressure)
- Clamp on only 6mm of material (20-25mm normal) saving expensive material waste
- Raw material stamped in seconds
- Workpieces can be re-inserted in material with an accuracy of $\pm 0.005\text{mm}$

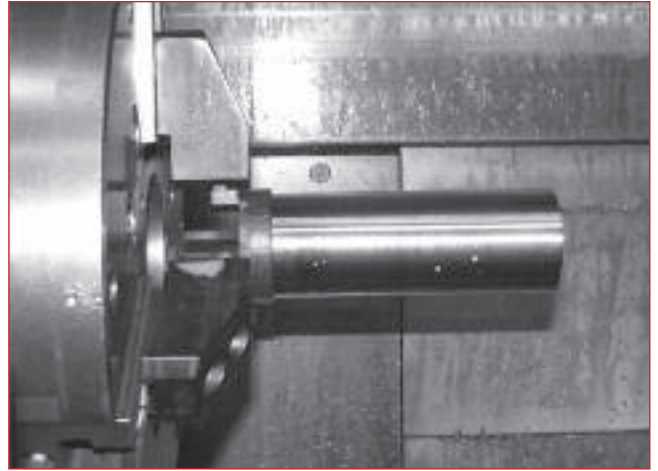

InoFlex®

Unbeatable 4 jaw chuck flexibility!

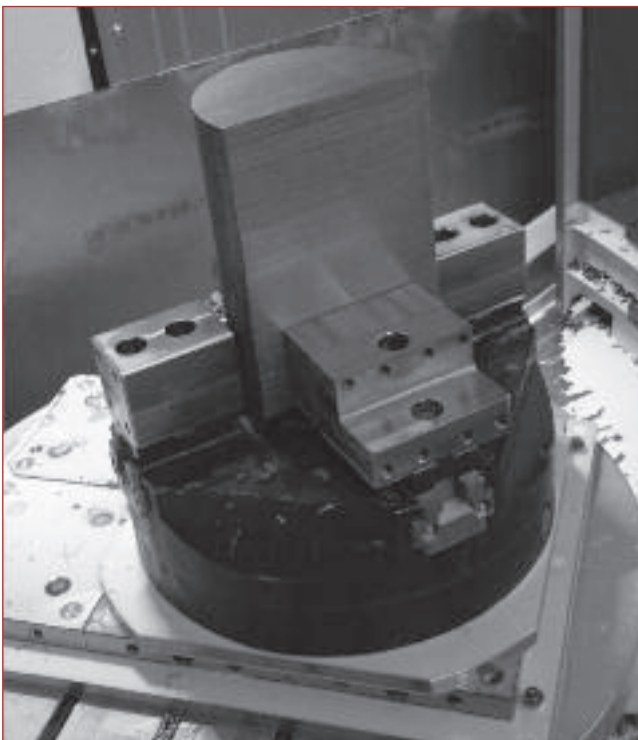

A new development solving workholding problems on combined turning/milling machines. InoFlex® permits compensating clamping of round, rectangular and also geometrically irregular parts.

- For concentric and compensating clamping
- Suitable for round, prismatic and irregular workpieces
- Reduces deformation on sensitive workpieces
- Can be used on turning and milling machines
- Available as manual clamping with range $\text{Ø}160\text{-}1200\text{mm}$

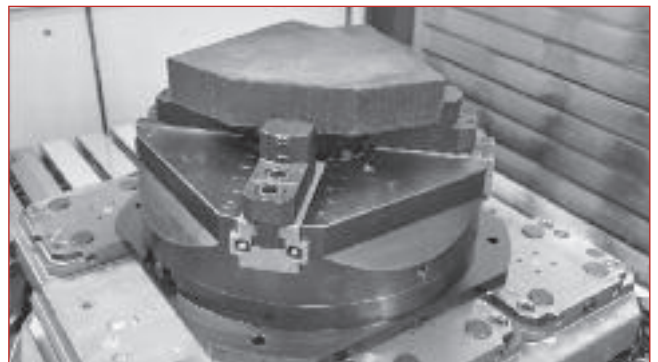

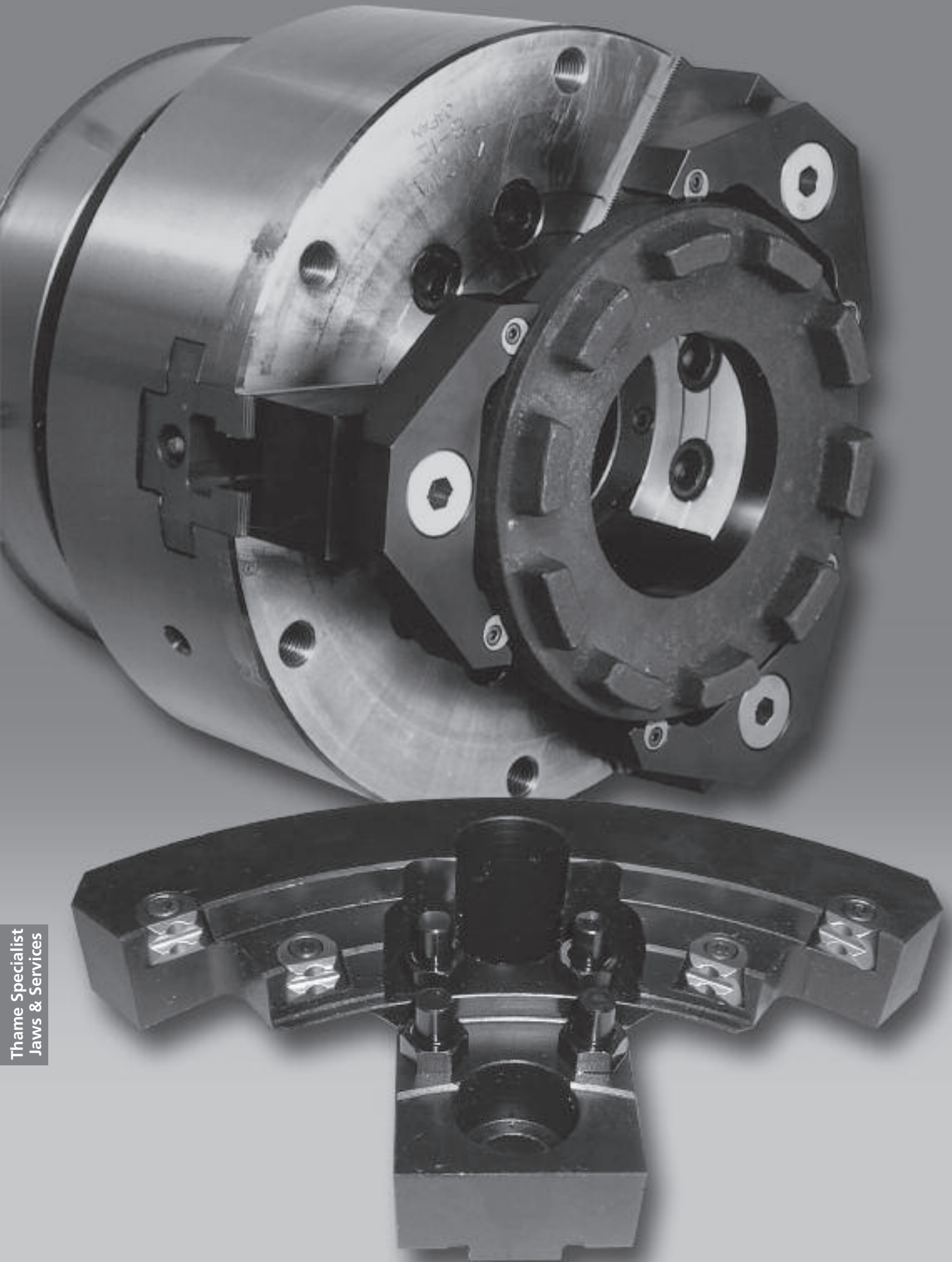

Thame Specialist
Jaws & Services

Specialist Jaws & Services

Page

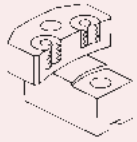

Multi-Point Rocker Jaws

- Hard jaws with grip inserts
- For clamping thin walled workpieces

148

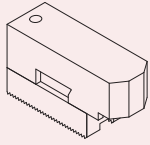

Quick Change Top Jaw System

- Convert your serrated power chuck to quick change

149

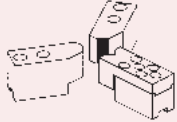

Tri Square Hard Jaws

- For clamping bar and square section on 3 jaw chucks

150

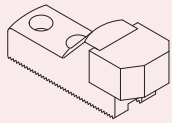

Insert System

- Plastic or aluminium inserts for gentle clamping

150

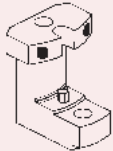

Design and Manufacture of Special Jaws

- Application Service

151



Replacement Chucks and Special Chucks

- Including cylinders, draw-tubes, etc.

152

Multi-Point Rocker Jaws

Multi-Point Rocker Jaws are designed for clamping thin walled workpieces that are often deformed when clamped with conventional width jaws on a power chuck. They lower the deformation of the workpiece by spreading the clamping force equally to six or twelve clamping points on its perimeter. The floating rocker arms allow the part to self centre thus overcoming irregularity in castings and forgings as the part is clamped.



Thame Workholding's standard design of Rocker Jaws covers many applications and each assembly comes complete with a Master Base Jaw, Pivot Bolt, Rocker Arm and Serrated Grip Inserts.

A set of Multi-Point Rocker Jaws will cover a specific range of clamping diameters whilst the depth of grip can be varied by using our standard height pins.

Using Multi-Point Rocker Jaws will assist in obtaining the best possible machined roundness on diameters and bores improving any out round to an acceptable level.

Multi-Point Rocker Jaws can improve deformation from hundreds of microns down to a single figure digit in some cases. Soft inserts or segments can also be used to allow second operation work with the rocking arms fixed.

We manufacture and design Multi-Point Rocker Jaws to suit all types of chucks including large vertical chucks up to 3 metres.

Standard Design

Available to suit a wide range of chucks contact our sales office for more information.

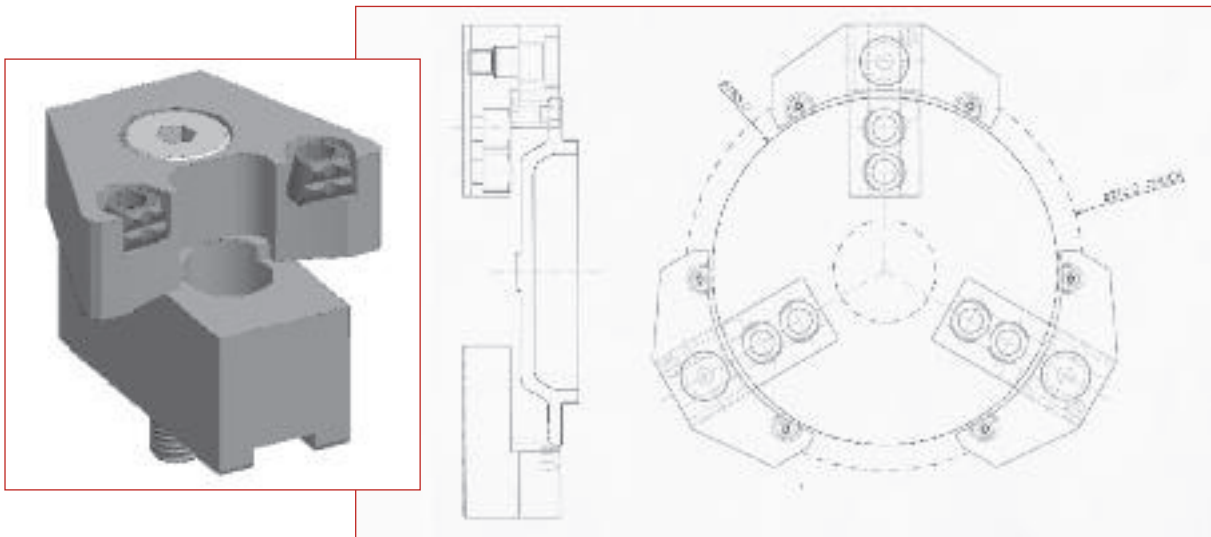

Special Design

We will design Multi-Point Rocker Jaws to suit your workpiece they could be six or twelve point contact jaws with all the necessary stops and location needed to clamp your part and reduce the out of roundness to an acceptable level. These are usually first operation jaws but provision for a second operation could also be possible.



Quick Change Soft Top Jaw System

- High Repeatability (0.020mm)
- Stable & Secure System
- Low profile Master Jaw
- Large Clamping Range Possible
- Changed in Seconds
- Other types available to order

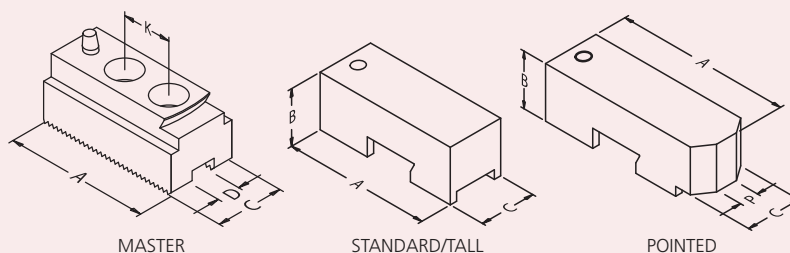

To suit • 1.5mm x 60° Metric Serrated Power Chucks

The TEC Quick Change Jaw system consists of a hardened intermediate jaw, which is mounted to and normally stays on the chuck base jaws. This intermediate jaw has a unique mounting for inexpensive top jaws. A set of top jaws can be exchanged for a different set in a few seconds with only the simple push of a button. Jaws can be quickly interchanged with high levels of repeatability so providing all the advantages of a quick-change chuck but at a fraction of the cost.

Master Jaws

PART No.	A	B	C	D	K	SERRATIONS	CHUCK Ø
QK 06	57.0	23.0	30.0	12.0	20.0	1.5mm x 60°	165mm
QK 08	67.5	27.5	31.8	14.0	25.0		200mm
QK 10	79.5	34.5	40.0	16.0	30.0		250mm
QK 12	85.5	34.5	50.0	18.0	30.0		315mm
QK 13	85.5	34.5	50.0	21.0	30.0		315mm
QK 15	116.0	45.0	63.5	22.0	43.0		380mm

Soft Top Jaws

PART No.	JAW TYPE	A	B	C	P	FITS MASTER JAWS
QS 06	STANDARD	72	35	30		QK06
QT 06	TALL	72	50	30		QK06
QL 06	POINTED	80	35	30	6	QK06
QS 08	STANDARD	90	40	35		QK08
QT 08	TALL	90	60	35		QK08
QL 08	POINTED	105	40	35	6	QK08
QS 10	STANDARD	100	40	40		QK10
QT 10	TALL	100	60	40		QK10
QL 10	POINTED	120	40	40	8	QK10
QS 12	STANDARD	110	50	50		QK12, QK13
QT 12	TALL	110	80	50		QK12, QK13
QL 12	POINTED	135	50	50	10	QK12, QK13
QS 15	STANDARD	130	80	60		QK15



Tri Square Top Jaws

For clamping square section on a 3 Jaw Chuck

Tri Square top jaws are adjustable hard top jaws used on three jaw chucks to clamp a range of square section. This simple but clever top jaw system removes the need in many instances to use 2 or 4 jaw chucks for the clamping of square section. Tri Square top jaws are ideal for clamping a series of square parts of different size because of the quick and easy adjustment from one size to another. Tri Square top jaws allow more universal use of three jaw chucks allowing the clamping of square and round section - when using chucks as fixtures horizontally on machining centres this can save costs on special fixtures.

Tri Square jaws are made to order to suit your chuck type and range of section size. Special shaped jaws can also be designed to suit irregular, rectangular and polygonal shapes.



Insert Systems

Plastic or aluminium inserts for gentle clamping

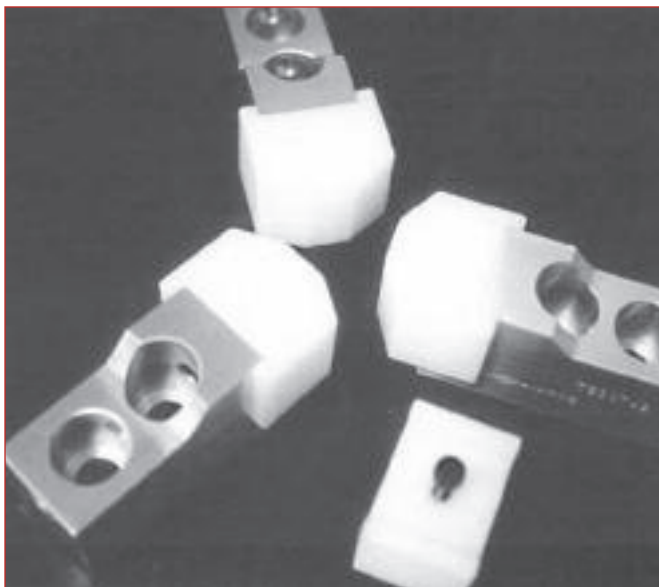

The use of inserts in a softer material can be an advantage when you need to clamp machined diameters during finishing operations. In this instance we offer to supply a range of plastic or aluminium inserts either standard width or wide to leave no marks when you clamp the workpiece.

The support jaws can be steel or aluminium depending on the application and can be for serrated or slot and tenon style chucks. This method of clamping is often used to hold fragile parts that would be marked or distorted in steel jaws.

Design and Manufacture of Special Jaws

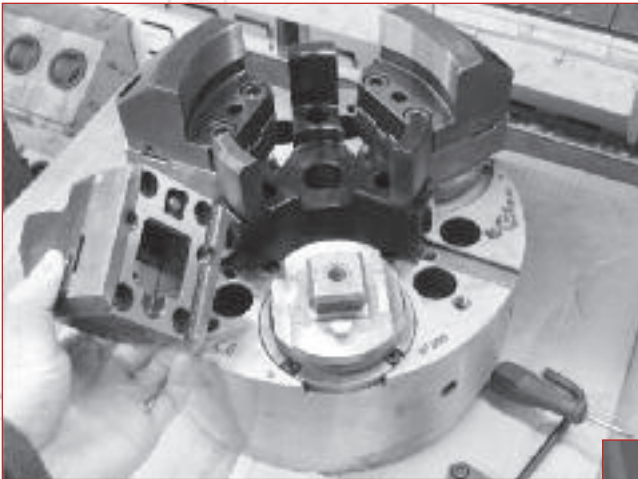

In house Design

In a perfect situation all applications would be covered by standard chucks and jaws, in reality to get the best performance or because it is technically impossible to hold the workpiece with standard products it is often necessary to use specifically designed chucks and jaws. This is where Thame ask you to let our specialist design engineers look at your problem and offer the optimum chuck and jaw solution. We will analyse your equipment and manufacturing operations to develop a specific recommendation to suit your workpiece.

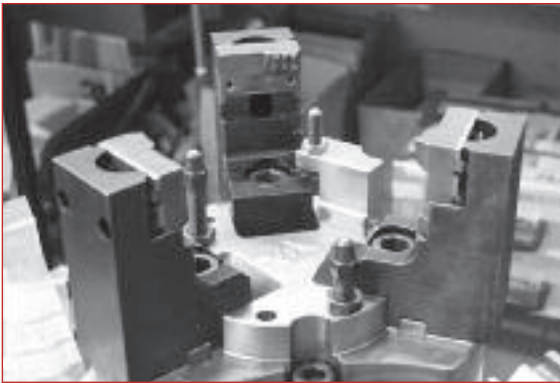

Special Jaws

We have over thirty years experience and know-how in the design and manufacture of special jaws. Every year we design and produce hundreds of innovative solutions to help our customers increase their productivity. This specialist knowledge is at your disposal, please try our service and join the large number of our customers who return time and time again because they are satisfied with the end result.

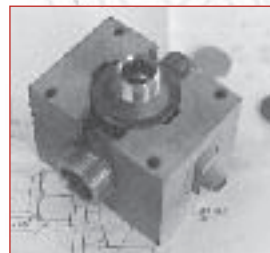
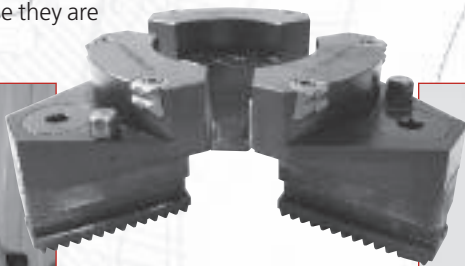





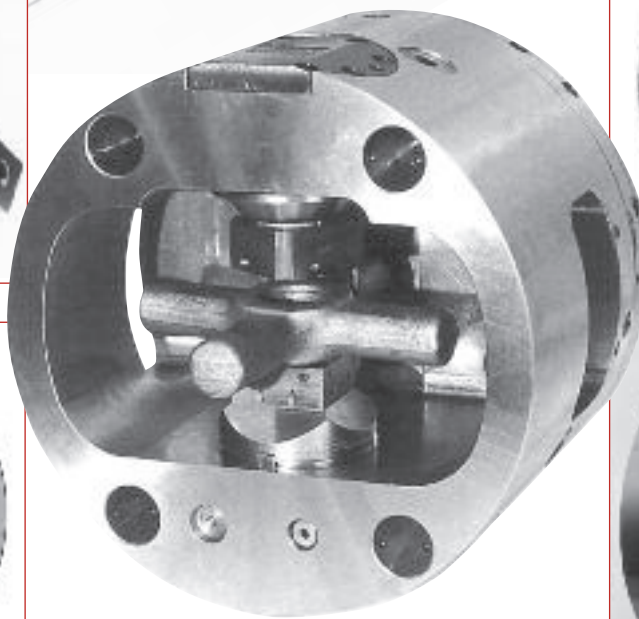
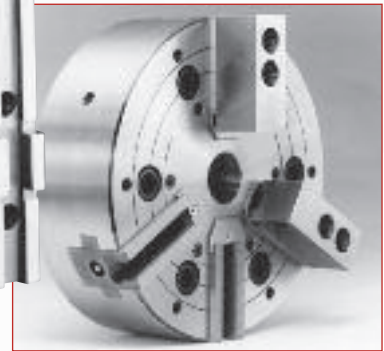
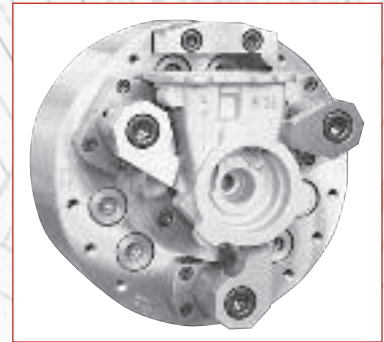
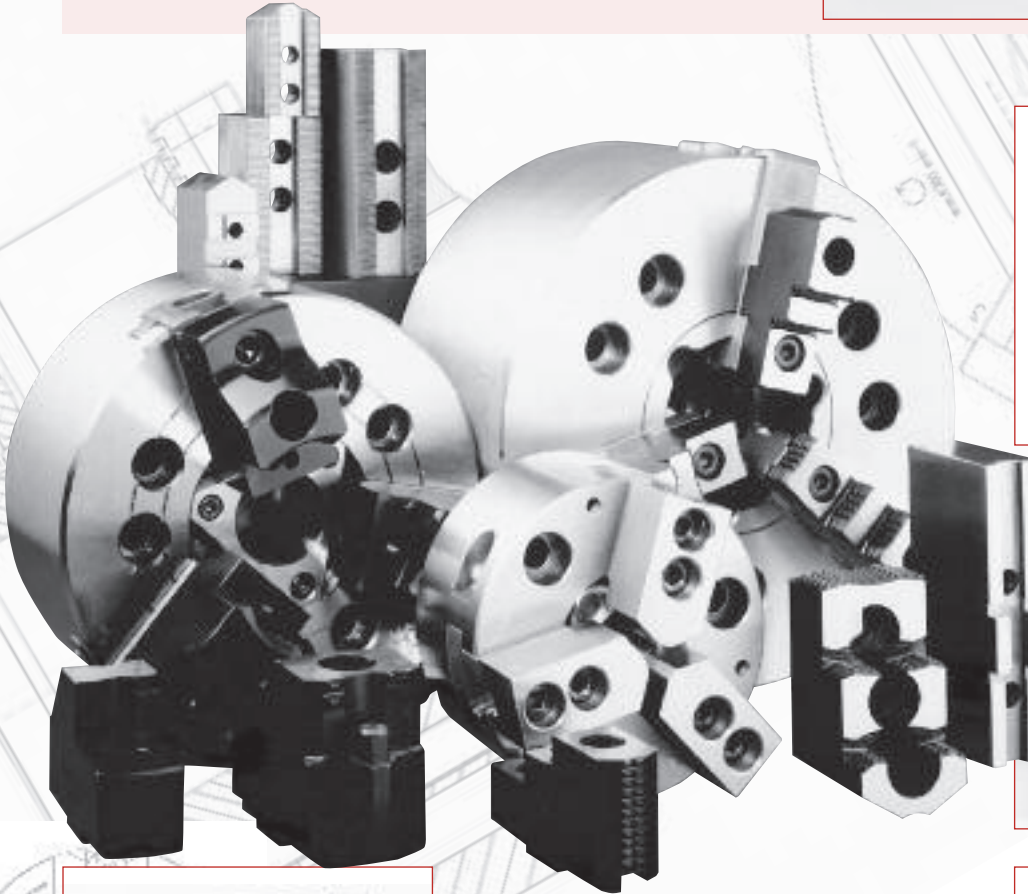
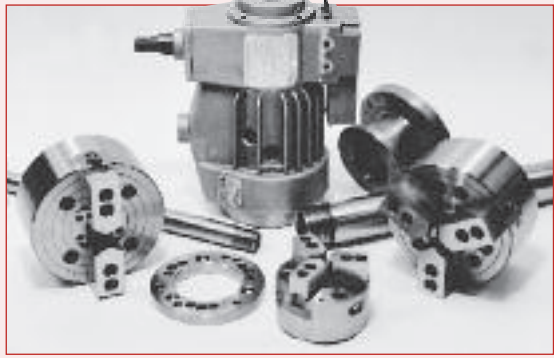

Thame Specialist
Jaws & Services

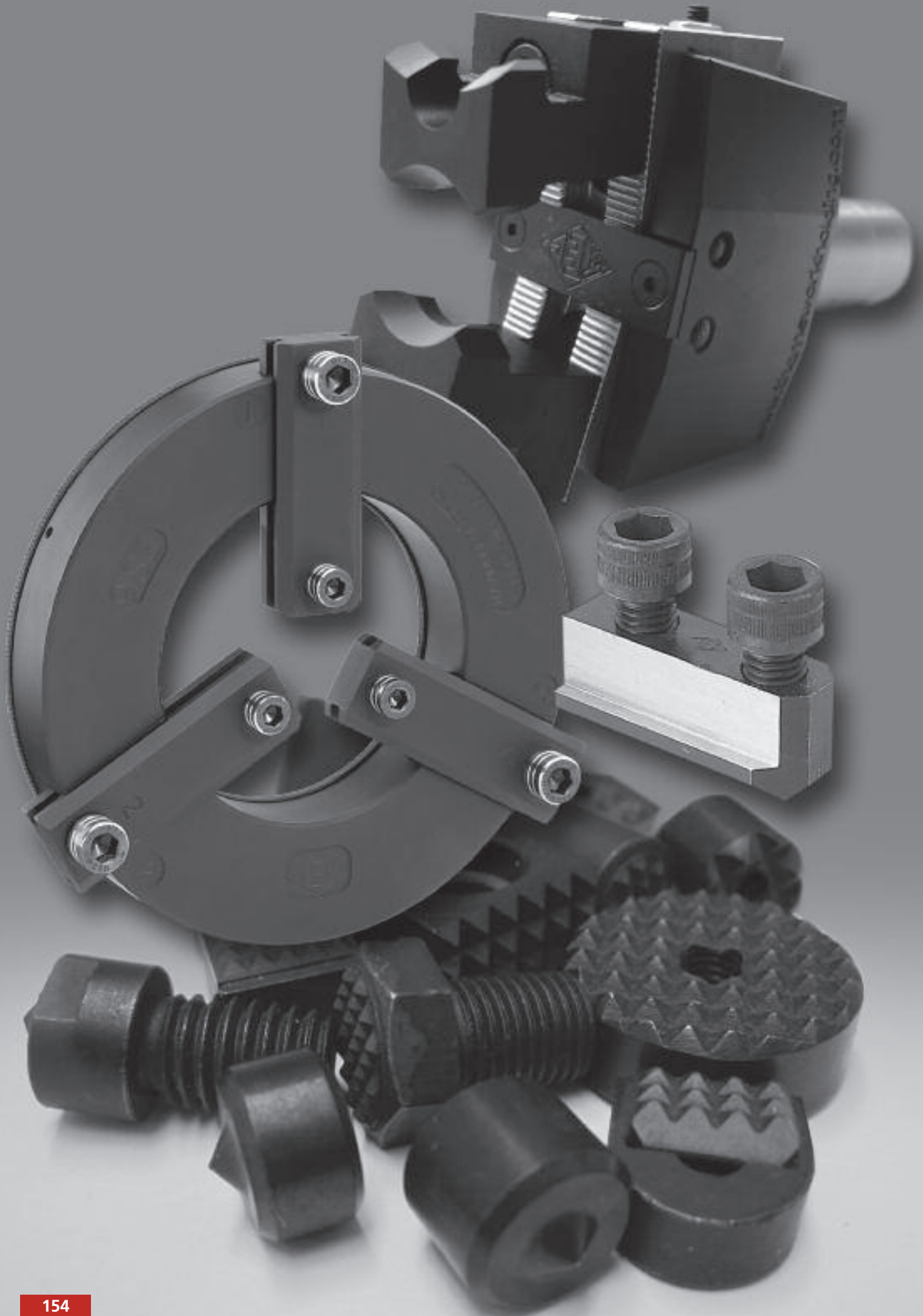
Replacement Chucks and Special Chucks

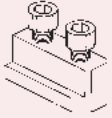
Manual and Power Chucks, including retro-fit systems to suit most applications. We will design, supply and fit complete packages –top tooling, chuck, adaptors, draw-tube/bar, connectors, cylinders and all ancillary products. We also design Special Chucks for customers to suit their application including Pull Back, Indexing and Eccentric Chucks.





T-Nuts and Accessories		Page
	Single, Double and Special T-Nuts	156 - 161
	Replaceable and Pivoting Grippers	162 - 164
	Serration Cleaning Plate	165
	Workpiece Height Pins	165
	Trueborer • Boring - Turning device	166
	Powerpull Bar Puller • Bar pulling chuck	167

T-Nuts

	Page
BERG	161
FORKARDT	156-157
GAMET	160
HOWA	158-159
KITAGAWA	158-159
MMK MATSUMOTO	160
NIKKO	160
PRATT BURNERD	156-157
RÖHM	160
SAMCHULLY	158-159
SCHUNK	156-161
SMW	156-161
SMW-AUTOBLOK	156-161

T-Nuts

Material:

- Steel: 817M40

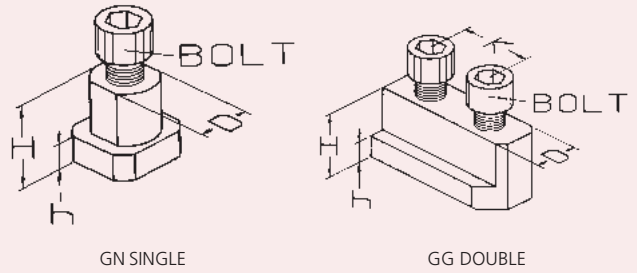

Chuck \varnothing 130mm - 800mm

PART No.	T-NUT TYPE	D	H	h	k	BOLT
GN 13	SINGLE	12	17	7		M8 x 20
GN 16	SINGLE	17	23	9		M12 x 30
GG 20	DOUBLE	17	23	9	22	M12 x 30
GG 16	DOUBLE	17	23	9	19	M12 x 30
GN 25	SINGLE	21	27	11		M16 x 35
GG 32	DOUBLE	21	27	11	28	M16 x 35
GG 25	DOUBLE	21	27	11	25	M16 x 35
GN 40	SINGLE	25.5	29	11		M20 x 40
GG 40	DOUBLE	25.5	29	11	35	M20 x 40

FORKARDT	PRATT BURNERD	SCHUNK	SMW
3KTH 130-33 3KTH 140-37			KDV 130
2BLE-PS 160/200; 2BLEF 200; KGGH 160/175/200; KGGH 160/175/200 KG 200; KL 160/200; KLNC 200; KP200 KS 160/200/250; KSF 175/200 KSH 160/200; KSHF 200/250; KSPS 160/200 KT 160/200; KTG 160/200; KTG 200 KTH 160/175/200; KTN 160/200 NH 160/175/200; NHF 160/175/200 QLC 160/175/200; QLC-KS 200/250; QLC-LS 160/200; QLC-AG 200; QLK 160/175/200; QLK-KS 200/250 UVE 160/200/250 NHK 250/290 (Index)	160 INTERNATIONAL 160 H S Q.C. 165 HYD. FRONT END 200 INTERNATIONAL 200 H S Q.C. 210 HYD. FRONT END 210 H S Q.C. 250 H S Q.C. 254 INTERNATIONAL 265 H S Q.C.	HSL 165/210; ROTA NC 165/210 ROTA NC-D 200; ROTA NC-F 165/210 ROTA HC-0 160/200 TH 165/210 THF 165/210	HFK 160/200 HFKS 160/200 KDV 160/200/250 KDVG 160/200/250 KFV 160/200 KFMF 160/200
2BLE 200; 2BLN 200; KG 250/315; KL 250; KLNC 250/315; KP 250/315 KS 315/400; KSH 250/315/400; KSHF 250/315/400; KSPS 250/300 KT 250/315; KTG 250/315; KTG 250/315; KTN 250/315 NH 250/257/260/315; NHF 250/315 QLC 250/315; QLC-KS 315/400; QLC-LS 250/315; QLC-AG 250/315; QLK 250/315; QLK-KS 315/400 UVE 315	250 INTERNATIONAL 254 HYD. FRONT END 305 HYD. FRONT END 305 INTERNATIONAL 305 H S QC 315 INTERNATIONAL 400 H S QC	HSG 315; HSL 250/315 ROTA NC 250 ROTA NC-D 250/315 ROTA NC-F 250 ROTA NC-F 315 ROTA NC-O 250/315 TH 250/315 THF 250/315	HFK 250/270/315 HFKS 250/315 KDV 315/400 KDVG 315/400 KFV 250/315 KFMF 250/315 KZF 200 KZF-ES 200
2BLE 250/315/400/500; 2BLE-PS 300/315/400/500 KG 400/500 KL 300/400/500; KLNC 400/500 KP 400/500 KS 500/630; KSH 500; KSHF 560/630; KSL 630 KS-PS 400 KTG 400/500/630; KTG 400/500/630 KTN 400/500/630 NH 400/500/630; NHF 400/500/630 QLC 400; QLK 400 UVE 400/500/630/800	400 INTERNATIONAL 400 HYD. FRONT END 500 HYD. FRONT END	HSL 400 ROTA NC 400/500 ROTA NC-D 400 ROTA NC-F 400/500 ROTA NC-O 400 TH 400/500 THF 400/500	HSL 400 ROTA NC-400/500 ROTA NC-D 400 ROTA NC-F 400/500 ROTA NC-O 400 TH 400/500 THF 400/500

T-Nuts

Material:

- Steel: 817M40

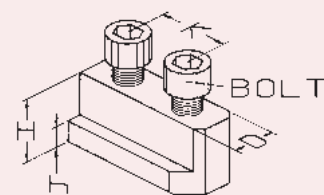

DOUBLE

Chuck Ø 110mm - 800mm

PART No.	D	H	h	K	BOLT	HOWA
GP 03	10	15	5.5	14	M8 x 20	H01MA4 H024M5
GP 04	8	13.5	4.5	15	M6 x 18	
GR 04	11	16.5	6.5	16	M8 x 20	H027M4 H027M5
GP 05	10	15.5	5.5	18	M8 x 22	
GP 06	12	21	7	20	M10 x 25	H01MA6 H015M6 H024M6 H047M6 H07MA6 H022M6 H027M6 H023M8 H037M6
GP 26	12	18.5	7.5	20	M10 x 25	
GP 07	12	18.5	7.5	20	M10 x 25	H3KT
GP 08	14	23	8	25	M12 x 30	H01MA8 H07MA8 H02M8 H015M8
GP 09	14	20.5	8.5	25	M12 x 30	
GR 10	16	26.5	8.5	25	M12 x 35	H07MA10 H015M10 H022M8 H024M8 H023M 10 H027M8 H047M8 H037M8 H034M8
GP 10	16	23	8	30	M12 x 30	H01MA10 H02M10
GP 11	16	21.5	8.5	30	M12 x 30	H3KT10
GR 12	18	27.5	9.5	30	M14 x 35	H07MA12 H024M10 H023M12 H037M10 H022M10 H015M12 H027M10 H034M10
GP 12	18	33	13.5	30	M14 x 45	H01MA12 H02M12
GP 13	21	28	11.5	30	M16 x 35	
GP 14	21	30	11.5	30	M16 x 30	
GR 13	21	29	10.5	35	M16 x 35	H027M12 H037M12 H034M12 H047M12
GP 15	22	45.5	16.5	43	M20 x 55	
GR 15	26	40	17	42	M20 x 45	H027M15 H047M15
GP 21	25	45	19	60	M20 x 55	
GP 24	25	45	19	80	M20 x 55	

KITAGAWA	SAMCHULLY	SCHUNK
B204; BT204 B205; BT205	HS-04; HS-05; HST-04; HST-05	
B-04; BT04 HOB 4	HCH-04; HTH-04	
HOB 5; HOB T-5 B-05; BT05	HCH-05; HTH-05	
HJA5-6; H06; N-160; AS165; NL-06; N-06 B-160; HOB-6; H05 6; HOH-160	HOH-06; HTH-06; HC-06; HCL-06 HCT-06; HCTL-06	HSL 165 (1.5x60°) ROTA NC 165(1.5x60°) ROTA NCF 165(1.5x60°)
BB206		
B206; B-06; BS306; BT206; B-07; HOH 06; HG738-165 B-106; B-7; BL206; BLT206; HOH 106; HOH 206	HS-06; HSL-06; HST-06; HH206; MH-206	ROTA NCK 165
HJA 6-8; B-200; HOB 8; H05 8; AS 210 HO 8; B-08; BT08; N-200; N8; HOH-8K	HOH-08; HC-08; HCL-08; HTH-08 HCTL-08; HCT-08	HSL 210; ROTA NC 210(1.5x60°) ROTA NCF 210(1.5x60°)
B-108; BL208; BLT 208; HOH-108; HG715-210 BB208; BS308; B 208; BT 208; HOH 208	HS-08; HSL-08; HST-08; HH208; MH-208	ROTA NCK 210
B-10; BT 10; HOH-10; HOB-10; AS 250; N-280; HO-10 HJAB-10; HOH 250; B-250; H05-10; HG730-254	HCH-10; HC-10; HCL-10; HTH-10; HCT-10	HSL 250; ROTA NC 250(1.5x60°) ROTA NCF 250(1.5x60°)
BB210; BS310; B-210; HOH 210 BT210; BL210; BLT210; B-110; HOH-110	HS-10; HSL-10; HST-10; HH210; MH-210	ROTA NCK 250
B-300; N-300; HOH-300; HLA6-12; B-12 N-12; HJA8-12; HO-12; HOB-12; H05-12 HLA6-15; HOH-12; HLA8-15	HCH-12; HCT-12; HC-12; HCL-12; HCT-12 HCTL-12	HSL 315; ROTA NC 315(1.5x60°) ROTA NCF 315(1.5x60°)
B-212; B-112; BT-212; BL212; BLT212 HOH-112; HOH-212	HS-12; HSL-12; HST-12; HH212; MH-212	ROTA NCK 315
BB212		
B-15; BT-15; B-380; B-450; HOB-15 HOH-15 HOH-380 B-18 HOB-18	HCH-15; HCH-18	HSL 400; ROTA NC 400(1.5x60°) ROTA NCF 400(1.5x60°)
HJ450; B530; HJ530; HOB21; B600 HOB24; HJ18; B21; HJ21; N21; B24; HJ24 N24; UVE-LB500/630 HOB24; HJA24; HJ24; UVB-LB800	HCH-21; HCH-24	

T-Nuts

Material:

- Steel: 817M40

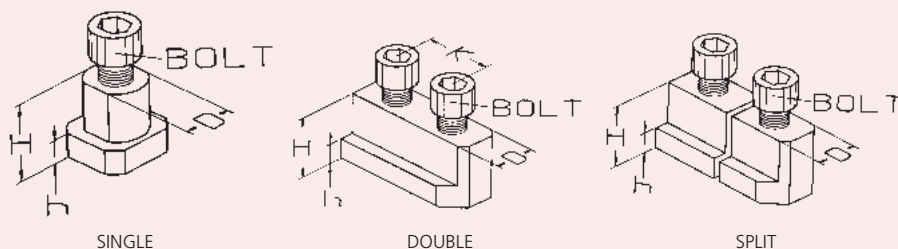

PART No.	T-NUT TYPE	D	H	h	K	BOLT	MATSUMOTO (MMK)
GS 05	DOUBLE	10	16.5	5.5	19	M8 x 20	ZA5-6
GS 06*	SPLIT	11	20	7.5	-	M8 x 25	HA5-6 HH-6 HX-6 HJ-6 H-6 STC-6
GS 07	DOUBLE	11	20	7.5	25	M8 x 20	ZA5-6
GS 08*	SPLIT	14	25.5	9.6	-	M12 x 35	HA6-8 HJ-8 HX-8 HHJ-8 H-8 HH-8 STC-8
GS 09*	SPLIT	14	24.5	8.5	-	M12 x 35	ZA6-8
GS 10*	SPLIT	16	23	8	-	M12 x 30	HA8-10 H-10 HHJ-10 HH-10 HHL-10 HX-10 HJ-10 HA8-11 STC-10
GS 11	DOUBLE	16	23	8	32	M12 x 30	ZA8-10
GS 12*	SPLIT	18	30	14	-	M14 x 35	HA8-12 HJ-12 HX-12 HHJ-12 H-12 HH-12 HHL-12
GS13	DOUBLE	18	30	14	32	M14 x 40	ZA8-12

* Split nut type

PART No.	T-NUT TYPE	D	H	h	K	BOLT	RÖHM
GE 13	SINGLE	12	17.7	7.5	-	M8 x 25	KFD 130 KFD-HE 130 KFH 140
GE 16	SINGLE	17	21	8.8	-	M12 x 30	KFD 160/200 KFD-HE 160/200/210 KFD-HF 160/200 KFH 160/200; KFL 250
GD 16	DOUBLE	17	21.5	9	19	M12 x 25	KFD-HS 200 LVE 200 SPD 160/215 SPO 160/215
GE 21/17	DOUBLE	21/17	25.5	11	-	M12 x 30	KFD-HS 250
GE 25	SINGLE	21	25	11	-	M16 x 35	KFH 250/315 KFD 250/315 KFL 315/400 SPD 300 KFA 200 KFD-HF 250/315 LVE 305/315 SPO 300 KFD-HS 315 KFD-HE 254/315 KFD 250/315
GE 40	SINGLE	25.5	33.7	15.5	-	M20 x 45	KFH 400/500 KFD-HF 400/500/630 KFL 500/600 KFA 250/315 KFD-HE 400/500/630/800 KFD 400/500/630/800 KFD-HS 400/500 LVE 400/500/630/1 000

PART No.	T-NUT TYPE	D	H	h	K	BOLT	GAMET	NIKKO-SUGA	RÖHM
GO 06	SINGLE	11	14.5	6.5	-	M8 x 20	130 N 130 MO 160 GO 160 N 160 MO 170 MF	HF-5 M0-5 HG-5 HF-6AB GO-6 HG-6AB HDM 165 MO-6	KFN 130/160 KFE 170 KFG 160 KFM 130/160
GO 08	SINGLE	14	15.5	6.5	-	M10 x 20	215 N 215 MO 215 GO 215 MF	HF-8 M08 HG-8 GO-8 MAC 165 HDM-215	KFN 215 KFM 215 KFG 215 KFE 215
GO 11	SINGLE	20	21.5	8.25	-	M12 x 30	250 N 280 N 280 MF 280 MO 280 GO	HF-10 HF-12 HG-10 MO10/12 GO-10/12 HDM 250/310	KFN 250 KFN 280 KFM 280 KFG 280 KFE 280
GO 14	SINGLE	21	25.5	11	-	M16 x 35	350 N 350 MO 350 GO 350 MF	HF-14 HF-16 MO14 MAC 250/315 HDM 250/280	KFM 350 KFG 350 KFE 280

T-Nuts

Material:

- Steel: 817M40

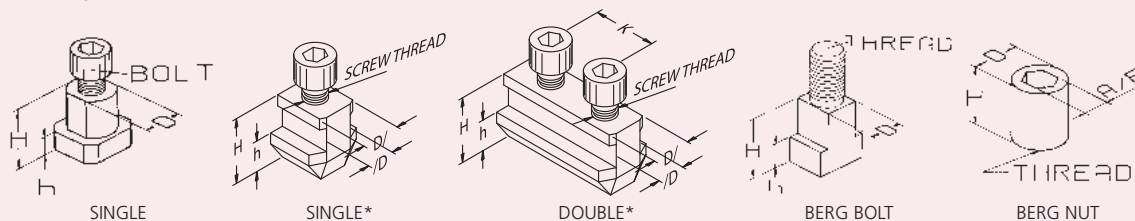

PART No.	T-NUT TYPE	D	H	h	K	BOLT	SCHUNK	SMW
GH 13	SINGLE	11	21.5	7.5	-	M8 x 30	TP125	125 SP 125 STWP
GH 16	SINGLE	14	26.5	9.5	-	M10 x 35	TP160	160 SP 160 STWP 160 STP
GH 20	SINGLE	17	27.5	9.5	-	M12 x 35	TP200	200 SP 200 STWP 200 STP
GH 25	SINGLE	21	30	11	-	M14 x 35		250/315 SP 250/315 STWP 250/315 STP
GH 26	SINGLE	21	30	11	-	M16 x 35	TP250/315	

PART No.	T-NUT TYPE	D	H	h	K	BOLT	SMW-AUTOBLOK
GF 17	SINGLE	14	20	7.5	-	M10 x 25	GHDN 165/170; GHD-FC 165; HDB170; HDL 170; HDN 170 IDL 170; IDN 170; ODN 170;
GF 18	DOUBLE*	14	18.5	6.5	16.5	M10 x 20	AL-D 165; AN-D 165; BB-D 165; BH-D 165; BHD-FC 165
GF 181	SINGLE*	14	18.5	6.5		M10 x 25	HB-D 165; HFKN-D 165; HYDN-S 180; PB-D 165; PBI-D 165
GF 182	DOUBLE*	14	18.5	6.5	20	M10 x 25	RC-D 165;
GF 183	DOUBLE*	14/12	18.5	6.5	20	M10 x 25	AN-M165; AL-M 165; BH-M 165; BHM-FC 165; PB-M 165 HB-M 165; BB-M 175; HFKN-M 165
GF 20	SINGLE	17	22	8	-	M12 x 30	GHDN 210; GHD-FC 210; HBD 200; HDL 200; HDN 200 IDL 200; IDN 200; ODN 200; IMN 200; IML 200; CD200
GF 21	DOUBLE*	17	20.5	7.5	23	M12 x 25	AL-D 210; AN-D 210; BB-D 210; BH-D 210
GF 211	SINGLE*	17	20.5	7.5	-	M12 x 25	HYDN-S 210/226; PB-D 210; PBI-D 210
GF 212	DOUBLE*	17	20.5	7.5	22	M12 x 25	BHD-FC 210; HB-D 210; HFKN-D 210; RC-D 210
GF 213	DOUBLE*	16/14	20.5	7.5	25	M12 x 30	AN-M 210; AL-M 210; BH-M 210; BH-FC 210; RC-M 210 PB-M 210; PBI-M 210; HB-M210; BB-M210
GF 25	SINGLE	21	25	11	-	M16 x 30	GHD-N 250/315/400; GHD-FC 250/305/400 HDB 300; HDL 250/315/400; HDN 250/315/400 IDL 250/315/400; IDN 250/315/400; ODN 250/315/400
GF 26	DOUBLE*	21	26.5	10	30	M16 x 35	BHD 250/315; RCD 250/315; BBD 250/315; AND 250/315 ALD 250/315; HBD 250/315
GF 261	SINGLE*	21	26.5	10	-	M16 x 35	AN-D 260/315; AL-D 260/315; BB-M 315; BH-M 315;
GF 262	DOUBLE*	21	26.5	10	28	M16 x 35	BHM-FC 315; HB-M 315; PB-M 315; HFKN-D 260/315
GF 263	DOUBLE*	21/16	26.5	10	30	M12 x 35	AN-M 250; AL-M 250; BH-M 250; BH-FC 250; RC-M 250; PB-M 250; PBI-M 250; HB-M 250; BB-M 250

• Berg T-Nut System

T-Bolt	D	H	h	THREAD
GB 10	10	20.3	9.3	M10
GB 12	12	23.2	9	M12
GB 16	16	26.7	12	M16
GB 20	20	32.7	16	M20

Nut	H	D	A/F	THREAD	BERG
GC10	16	16	8.1	M10	KH 140/160
GC 12	19	17.8	10.1	M12	KH 175/200
GC16S	25	24.5	14.1	M16	KH 250/315
GC 20	32	32	22.1	M20	KH 400/500/630

Replaceable Gripper Inserts

Suitable for Chuck Jaws and Fixtures

Carbide Tipped Round Design

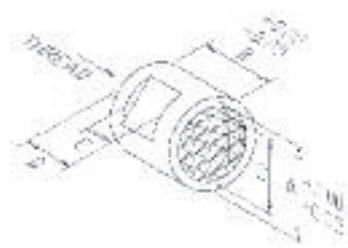

PART No.	A	B	C	D	E	TAPPED
EU 2A	12.7	9.5	9.5	6.7	4.7	M6
EU 2B	12.7	12.7	9.5	8.3	4.7	M6
EU 2C	12.7	16.5	9.5	9.9	4.7	M6
EU 5A	15.9	9.5	12.7	6.7	4.7	M6
EU 6A	19.0	9.5	15.9	6.7	4.7	M6

Carbide Tipped Square Design



PART No.	A	B	TAPPED
EU 7A	12.7	9.5	M6

- Carbide gripping faces for long life
- Cost effective—just replace insert when worn
- Diamond point gripping serrations for positive grip
- Can be used with special jaws or soft jaws

Gripper inserts are retained by either set screw from side to flat on o.d. of gripper or by cap screw from back.

Hardened Tool Steel-Round Design

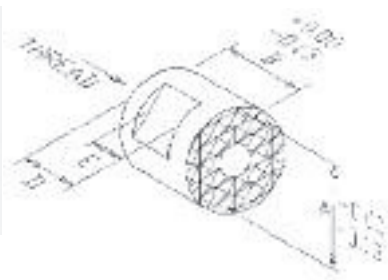

PART No.	A	B	C	D	TAPPED
EW 10	12	10	6.8	4.7	M5 x 0.8
EW 15	12	12	8.4	4.7	M5 x 0.8
EW 20	16	10	6.8	4.7	M6 x 1.0
EW 25	20	10	6.8	4.7	M6 x 1.0
EW 30	25	10	6.8	4.7	M6 x 1.0

Square Design

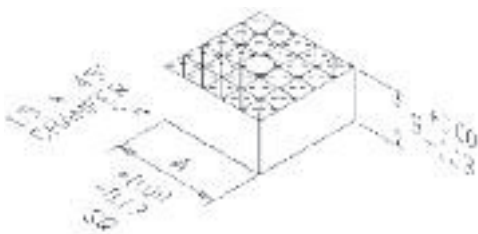

PART No.	A	B	TAPPED
EW 40	12	10	M5 x 0.8

- Hardened tool steel grips for high shock load when loading or unloading.

Replaceable Gripper Inserts

Suitable for Chuck Jaws and Fixtures

Hardened High Speed Steel - O.D. Grip Design



Inclusive of socket head screw

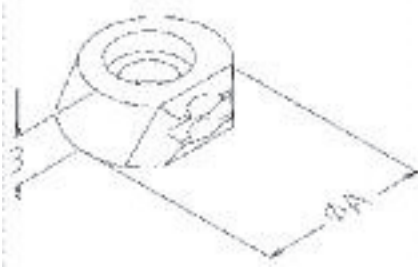

- Unique shape for OD or ID Gripping.
- Top mounting of bolt.
- Can be used for self-centering or pivoting.
- Pull down effect by wedge shape design.
- Inclined cutter easily machines seating pocket.

PART No.	A	B
EZ 05	16	10

Mounting Instructions:

1. Part $\varnothing + 4\text{mm}$ (0.16 inch) + seat turning or milling.
2. Milling of pocket + drilling and tapping.

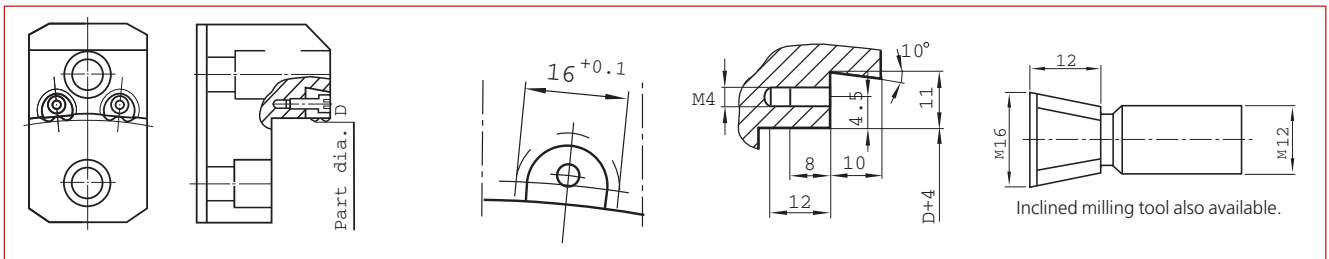

Pivoting Gripper Ball Units

Suitable for Chuck Jaws and Fixtures

Hardened Tool Steel Ball Types

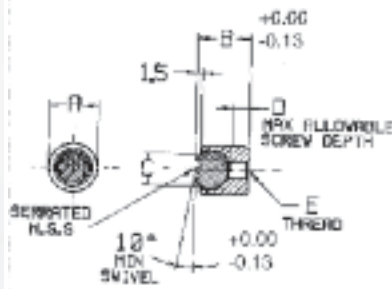

PART No.	A	B	C	D	TAPPED
EY 05	10	12	6	3.5	M4 x 0.7
EY 10	10	25	6	9.0	M4 x 0.7
EY 15	13	16	8.5	6.5	M5 x 0.8
EY 20	13	25	8.5	9.0	M5 x 0.8

Self aligning grippers that adjust to the workpiece draft angle or irregular surface giving secure workholding.

Hardened Tool Steel Pad Types

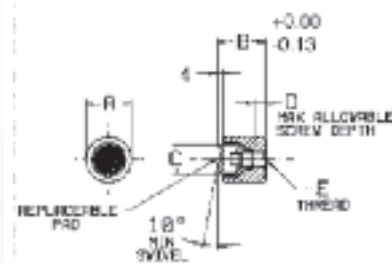

PART No.	A	B	C	D	TAPPED
EX 05	19	24	12	8.5	M8 x 1.25
EX 10	24	28	16	9.0	M10 x 1.50
EX 15	30	30	20	8.5	M12 x 1.75
EX 20	36	36	25	12	M12 x 1.75

Carbide or Flat Pad on request.

Replaceable Gripper Inserts

Suitable for Chuck Jaws and Fixtures

Carbide or Hardened Tool Steel - Angle Grip Design

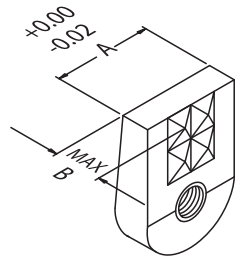
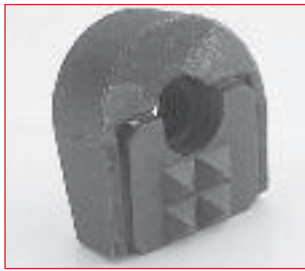

4 Point

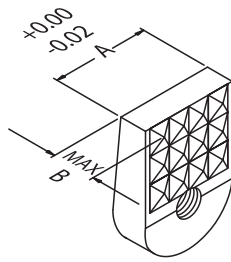

12 Point

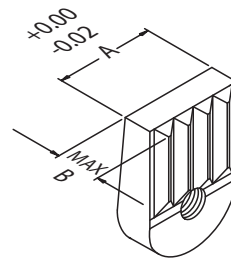

Straight

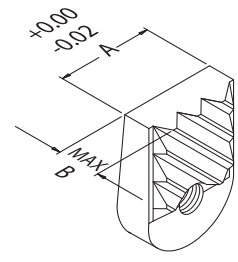

Angular

- Ideal for Pull Back Chucks
- Carbide or Hardened Tool Steel

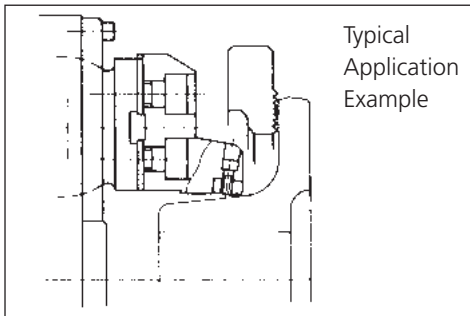

- Ideal for Pull Back Chucks
- Carbide or Hardened Tool Steel

THAME PART No.	A	B	TAPPED	MATERIAL	TOOTH PATTERN
EU 60	14.27	9.5	M5 x 0.8	CARBIDE	4-Point
EU 65	14.27	9.5	M5 x 0.8	CARBIDE	12-Point
EU 70	14.27	9.5	M5 x 0.8	CARBIDE	Straight
EU 75	14.27	9.5	M5 x 0.8	CARBIDE	Angular
EW 60	14.27	9.5	10-32 UNF	HARDENED TOOL STEEL	4-Point

Hardened High Speed Tool Steel Edge Grippers

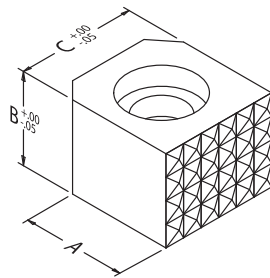

PART No.	A SQUARE	B	TAPPED	D
EW 70	12	6	M4 x 4.06	2.3 x 45°
EW 71	12	10	M4 x 4.06	2.3 x 45°
EW 72	12	12	M4 x 4.06	2.3 x 45°
EW 73	20	6	M8 x 5.08	3.2 x 45°
EW 74	20	12	M8 x 5.08	3.2 x 45°

Hardened Tool Steel-Round Design

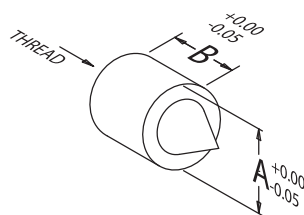

PART No.	A	B	TAPPED
EW 80	6.4	9.5	8-32 UNF
EW 81	6.4	12.7	8-32 UNF
EW 82	12.7	9.5	10-32 UNF
EW 83	12.7	12.7	10-32 UNF

Serration Cleaning Plate



Serration plates are available in three standard types, each supplied in a sturdy plastic case with a tube of lapping paste.

- Allows quick and easy cleaning and deburring of serrated chuck jaws.
- Improved accuracy of mounting to base jaws.
- Extends the working life and precision of the top jaws.
- Keeps jaw serrations in perfect condition.
- Different serration type on both sides of the plate.

Simply apply lapping paste and guide jaw onto serrations on plate, move jaw back and forth until serrations are in top condition.

PART No.	SERRATION TYPE
ES96	1/16" x 90° and reverse 1.5mm x 60°
ES99	1/16" x 90° and reverse 3/32" x 90°
ES66	1.5mm x 60° and reverse 3mm x 60°

Workpiece Height Pins

- Material En32 Hardened & Ground
- Workpiece Height Pins are for use with Adjustagrip hard jaws or special jaws requiring a workpiece height location.

Height Pins of a different height or Thread are available on request.



PART No.	H	WIDTH ACROSS FLATS	THREAD	SUITS ADJUSTAGRIP JAW RANGES
IT05	5	10	M6	LA, LB, MA, MB
IT10	10			IA, IB, JA, JB
IT15	15			LY10 TO LY35
IT20	20			
IU05	5	13	M8	LC, LD, LE, LF, LG, MC, MD, ME, MF, MG
IU10	10			IC, ID, JC, JD
IU15	15			LY40 TO LY55
IU20	20			
IU25	25			

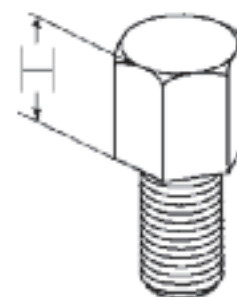

Quick Jaw Change Base Jaw Bolts

PART No.	BOLT SIZE	TO SUIT BASE JAW TYPE
QA12	M8 x 1 x 20	MFG 160, MFG 200
QA32	M12 x 1.5 x 30	MFG 250
QA33	M12 x 1.5 x 35	MFG 315
QA54	M16 x 1.5 x 40	MFG 400
QB12	M8 x 20	GBK 140, GBK 160, GBK 200
QB31	M12 x 25	GBK 250, GBK 315
QB32	M12 x 30	GBK 400
QB55	M16 x 45	GBK 500, GBK 630



Trueborer

Jaw Boring-Turning Fixture for Power Chucks

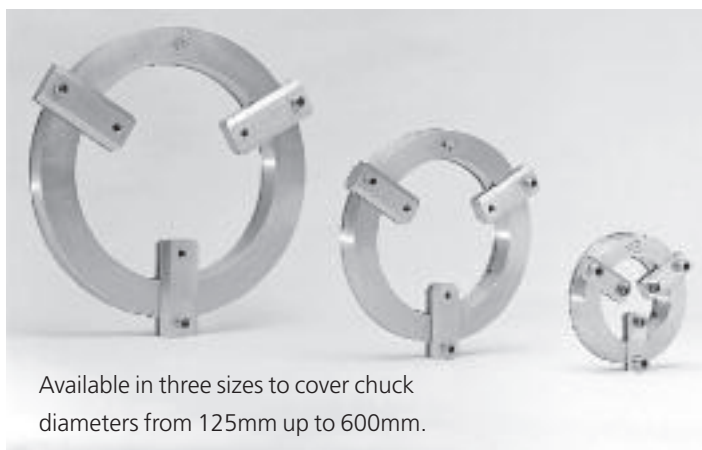
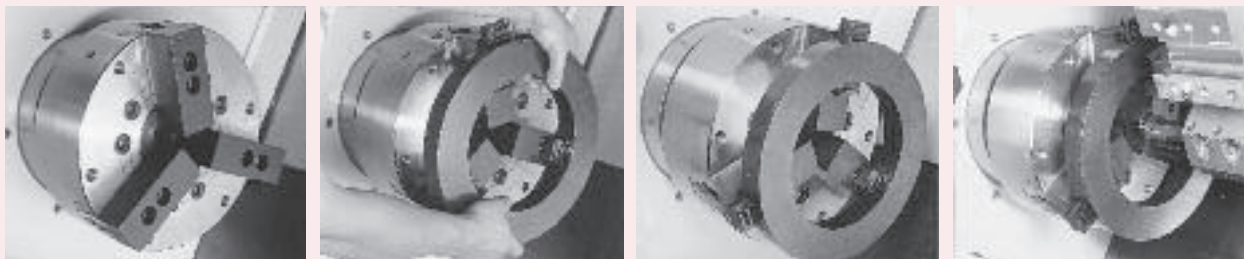

Available in three sizes to cover chuck diameters from 125mm up to 600mm.

- Quick clamping of top jaws to produce a perfectly concentric bores or turned diameters
- Allows jaws to be bored or turned at the same clamping pressure required to hold the workpiece
- Only one operation even if through boring jaws
- Saves on jaw usage because of the adjustment allowing minimal skimming of jaws
- No time wasted looking for, or turning clamping rings
- One Trueborer can be used on many chucks
- For grinding, boring or turning of soft or hard top jaws

THAME PART No.	BEST SUITED FOR CHUCK DIAMETER	RING INTERNAL DIAMETER	RING EXTERNAL DIAMETER	JAW BOLT DIAMETER RANGE	BOLT DIAMETER	WEIGHT Kg	MAX. CLAMPING PRESSURE
ES16	125-200	100	180	30-250	13 & 16	4	8000 da N
ES25	250-315	195	295	100-340	16	10	10000 da N
ES42	400-600	310	420	180-550	18.5	20	13000 da N

Operation

- Set top jaws on chuck master jaws to obtain required clamping diameter.
- Rotate the back plate on the trueborer to position the jaw slides so the boltheads can be inserted into the counterbore holes of the top jaws (make sure the bolts are in the correct hole on the slides).
- When in position continue to turn the backplate clockwise for boring or anti-clockwise for turning until it stops and is held tight and parallel against the top jaws.
- Clamp up chuck, Trueborer will hold jaws in required position of chuck stroke to bore or turn jaws under pressure.

The easiest way to bore or turn Soft Jaws

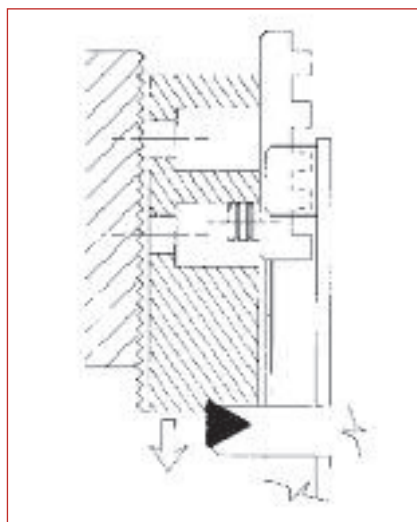

Powerpull Bar Puller

- Two body sizes
- Bar capacity 6 - 90mm
- Adjustable gripping pressure
- Robust construction
- Unit supplied with one pair reversible gripping jaws
- Choice of plain or VDI shank

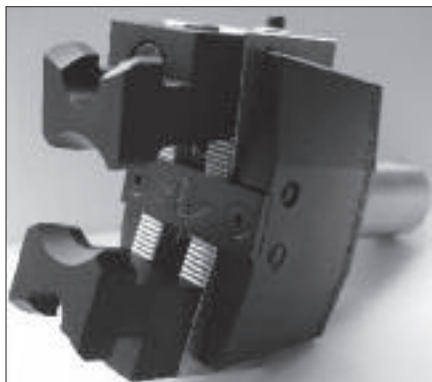

The Powerpull Bar Puller is for use on CNC or Automatic Lathes with an interchangeable tool turret. It is designed to pull bar stock and tubes into position for machining purposes, thus giving the ability for unmanned operation, without the expense and room needed with a bar feeder. The Powerpull is a two-jaw lever chuck with variable tensioning jaws which cater for most types of material. It comes in two body sizes each with one set of reversible clamping jaws. This easy to set Bar Puller has adjustable gripping pressure and comes with a choice of standard plain or VDI shanks. Special jaws can be designed and manufactured to suit unusual applications.

THAME PART No.	BODY DATA							GRIP RANGE x	PLAIN SHANKS	VDI SHANKS	CLAMPING FORCE kN	
	A	B	C	D	E	F	U				MIN	MAX
ER 04	85	49	50	11	59	M8	2.5	6 - 36	32 Dia.	30 Dia.	1,30	1,70
								34 - 64	40 Dia.	40 Dia.		
									50 Dia.	50 Dia.		
ER 06	120	60	60	14	72	M10	3	6 - 60	32 Dia.	30 Dia.	2,00	2,70
								50 - 90	40 Dia.	40 Dia.		
									50 Dia.	50 Dia.		

Technical Data

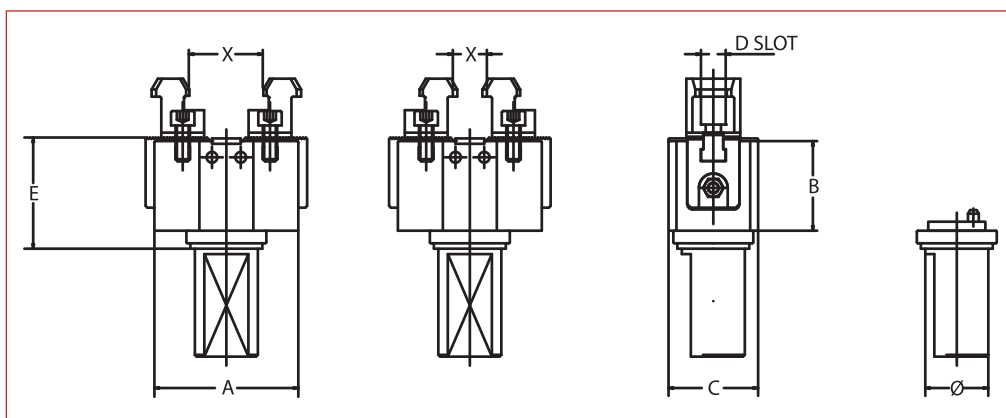

Powerpull on turret pulling bar into position

Operating Description

The bar stock is initially fed manually through the machine's hollow spindle to a fixed stop, the bar is then clamped by the spindle mounted chuck or collet and machining sequence completed. The Powerpull mounted in the turret is brought towards the headstock and the jaws of the Powerpull are forced over the bar clamped in the spindle chuck. The spindle chuck is then unclamped and the spring gripping jaws of the Powerpull grip the bar stock, enabling a positive bar drag out to a pre-determined stop position. The spindle chuck is then re-operated to clamp the bar and the turret is withdrawn further to release the jaws. The bar is then ready for the machining process to be repeated.

Technical Information

Jaw Location Dimensions

Chuck manufacturers often supersede or change specifications on jaw location details so it is important to check that the dimensions listed below correspond with your existing top jaws, master jaws and chuck.

Serrated Jaws

- L = pitch & angle of serrations
1.5mm x 60° ; 1/16" x 90°
3mm x 60° ; 3/32 x 90°
- D = slot width (locates on t-nut)
- K = Hole centre spacing
- G = bolt hole (see note below)

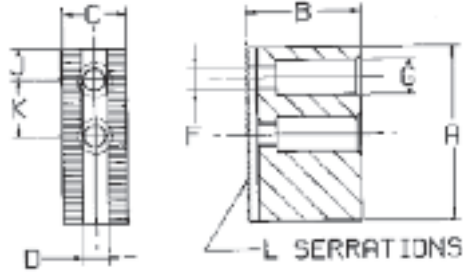

Slot & tenon Jaws

- D = slot width
- S = tenon width
- K = hole centre spacing
- G=bolt hole (see note below)

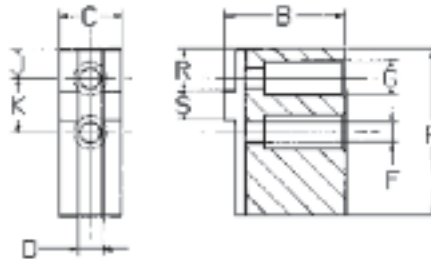

Scroll Jaws

- C= jaw width
- D=slot width
- J=tooth pitch

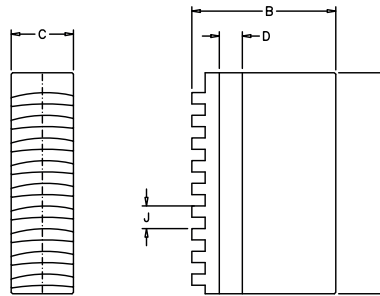

Note: remember the bolt hole will have clearance on the bolt. It is important that these dimensions are measured accurately. The use of a vernier or micrometer is recommended.

Please Note

Whilst every effort is made to make sure the information relating to technical data is correct, manufacturers do change specifications of their products and subsequently Thame Workholding shall not be liable for any loss or consequential damage whatsoever that may arise from the use of the products or the use of information or particulars in, or any error or omission in this catalogue. The responsibility of correct fit and use must lie with the user and the information in this catalogue only used as a guide.

Soft Scroll Jaws

Thame Workholding soft scroll jaws have been manufactured to allow for a small degree of wear in the chuck guide way, therefore the slots are slightly undersize and the width slightly oversize. A minor amount of adjustment may be required to obtain a correct fit, particularly if the chuck is new.

Concentricity

Thame Workholding manufactured standard hard jaws are made to a 0.05 – 0.07mm concentricity tolerance using our purpose made fixtures. For optimum concentricity jaws must be hard turned on the chuck in situ on the machine. Please Note: The condition of the chuck has a great bearing on concentricity and repeatability of jaw sets. Regular servicing of chucks will prolong their life and maintain a higher level of operating accuracy. For unparalleled concentricity when boring standard soft jaws a Thame Workholding Trueborer is recommended (see page 166).

Technical Information

Grip Loss Due To Centrifugal Forces

The following chart shows the typical grip loss for different types of standard jaws on a 200mm diameter wedge type chuck.

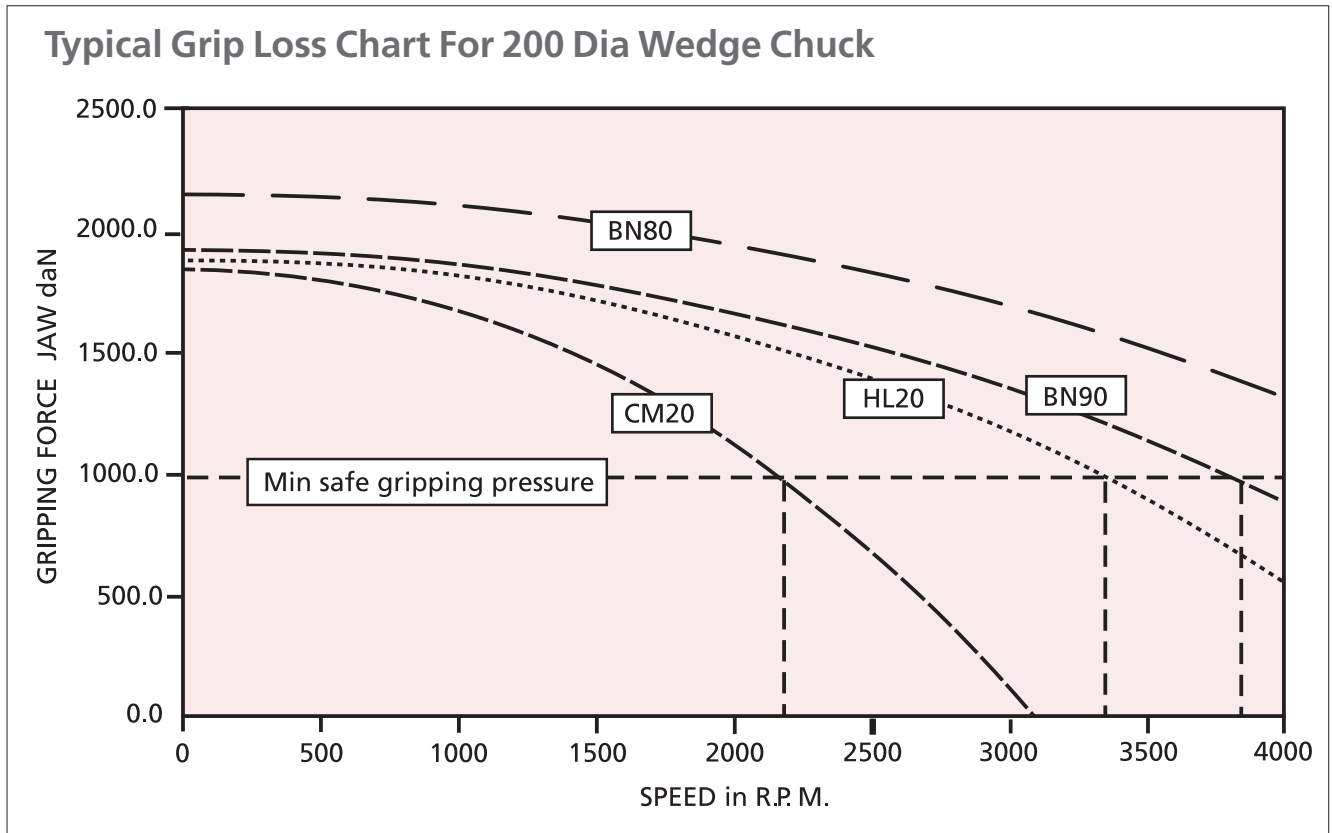

JAW CODE	JAW TYPE	JAW MATERIAL	WEIGHT PER JAW
BN80	Std. Soft Jaw	Mild Steel	0.93Kg
BN90	Tall Soft Jaw	Mild Steel	1.23Kg
CN20	Diamond Jaw	Mild Steel	4.66Kg
HL20	Diamond Jaw	Aluminium	1.66Kg

Conversion Factors: 1kN = 100daN 1kgf = 9.806 N

Typical Gripping forces (for external gripping) can be calculated using the following formulae.

For drawtube/bar operated chucks

$$G_f = S_f F_o / (1 + J_h G_h) - G_l S^2 (MR + B_j)$$

For pneumatically operated chucks

$$G_f = S_f P_o / (1 + J_h G_h) - G_l S^2 (MR + B_j)$$

Technical Information

Grip Loss Due To Centrifugal Forces

Where Gr= Chuck Gripping Force (daN)

Fo= Operating Force of drawtube actuated chucks in daN

Po= Operating Pressure of pneumatically actuated chucks in daN.

S = Speed of chuck in thousandths of R.P.M. (i.e. 6000 RPM = 6)

M = Mass of top jaw in Kg.

R = Radius of grip in cm

Gh= Height of top jaw in cm.

And Sf, Gf, Bj, Jh, & Pf are constant values associated with specific chuck types and typical values are found in the tables A,B, & C below.

Note: For internal gripping the centrifugal force is additive, the minus sign in the above formulae therefore becomes a plus sign.

Table A

For standard wedge type chucks

CHUCK SIZE	160	200	250	305	380
S _f	0.80	0.80	0.80	0.80	0.80
G _f	7.5	7.5	7.5	7.5	7.5
B _j	2.3	5.2	8.9	15.9	34.0
J _h	0.08	0.06	0.05	0.04	0.03

Table B

For Compensating chucks

CHUCK SIZE	160	200	250	305	380
S _f	0.75	0.77	0.91	0.91	0.80
G _f	8.0	8.0	8.0	8.0	8.0
B _j	-1.5	-4.2	-6.0	-11.5	-22.0
J _h	0.08	0.06	0.05	0.04	0.03

Table C

For Pneumatic chucks

CHUCK SIZE	160	200	250	305	380
P _f	173	256	380	462	473
G _f	6.2	6.2	6.2	6.2	6.2
B _j	2.8	5.3	10.2	15.9	19.6
J _h	0.075	0.070	0.055	0.040	0.045

Note: The above charts are typical examples only and should not be applied without consultation with chuck manufacturers or chuck manuals.

Technical Information

Materials

Most Thame Workholding standard jaws are manufactured from either 080M15 (EN32) low carbon steel or 590M17 (16MnCr5) alloy steel which can be case hardened for long term durability. Other materials can of course be used, for example more exotic steels, aluminium's, plastics and composites and these are all available as specials. T-Nuts are manufactured from EN24 heat-treated to the 'T' condition.

Below is a simple table showing British Standard and corresponding German reference numbers for various steels used in the production of Thame Workholding products.

MATERIAL	BS 970/83	BS 970/55	GERMAN
Steel	080M15	En32	C15
Steel	665M17	En34	
Steel	080M40	En8	C45
Steel	590M17		16MnCr5
Steel	817M40	En24T	40NiCrMo6

Unless otherwise stated all special jaws will be manufactured using the materials specified on the drawings supplied by the customers.

Heat Treatment

All Thame Workholding standard soft jaws can be case-hardened using heat treatment. See chart below for guidelines.

	Depth of Case	MATERIAL TYPE	
		080M15 (En32)	590M17 (16MnCr5)
		Rockwell Hardness 'C'	
Thin Section	0.38 – 0.5mm	54 - 56	57 – 59
Normal Section	0.63 – 0.75mm	56 - 58	58 – 60
Thick Section	0.76 – 1.00mm	57 - 59	59 - 61

Top Jaw Weights

Careful consideration must be given when fitting oversize top jaws to a rotating chuck because the safety and performance of the chuck will be compromised. Although the calculations given in the chart on page 169 can establish approximate theoretical grip loss, the most accurate method is to establish the actual performance of the jaws on the machine; this can usually be carried out by use of a grip meter.

Thame Engineering offer grip meter equipment for sale or hire and in either case full instructions for use and any advice required are included. Please contact our sales office for further details.

CE Regulations

The Supply of Machinery (Safety) Regulations 1992 became fully effective on the 1st January 1995 and in accordance with its requirements Thame Workholding will supply Declarations of Incorporation where necessary. It is possible that this legislation, or at least parts of it, will be amended in the future. As and when these changes occur Thame Workholding will make every effort to comply with these regulations.

Technical tips

If possible always bore or turn soft jaws at the same chuck pressure that you clamp the workpiece. One easy way to do this is with the TEC Trueborer (see page 166)

Serrated jaws generally offer more positional flexibility than slot/tenon style jaws. However slot/tenon jaws usually have a fixed position and hence offer the likelihood of attaining good repeatability more frequently if removed from the base jaws.

Replacement Hard Reversible Jaws may not be as accurate as the original jaws supplied with the chuck, because the originals would have been ground on the chuck under clamping pressure. To attain the same concentricity the replacement jaws would need to be ground or hard turned under pressure on the chuck in situ. Generally replacement jaws are used to clamp un-machined surfaces and a slight run out is acceptable.

Hard jaws or soft jaws? Generally soft jaws are used for second operation work on a machined diameter or where teeth marks cannot be removed. Hard Jaws offer safer and more arduous machining with the teeth biting into the material (see the Adjustagrip ranges in the catalogue).

Save time and keep your T-nuts loosely attached with each set of jaws when off the chuck. It is very quick and easy to position this loose unit on the chuck when changing sets reducing costly set up time.

When the workpiece is gripped the jaw stroke should always be at mid-stroke especially when boring or turning soft jaws. Hard jaws can be used with more or less but a safety margin of a quarter of the stroke should always be maintained.

Always adhere to the manufacturer's manual and grease chucks regularly as this has a big impact on clamping forces it will also affect repeatability, operator safety and longevity of chuck life.

If large or heavy jaws are used be sure you are within the guideline limits outlined in the chuck manufacturers and our own our technical section (pages 168-171). Large Jaws and workpieces can severely affect a chuck's performance and cause unbalanced and dangerous conditions.

T-nut Safety

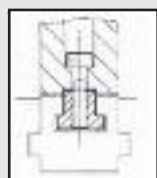

CORRECT

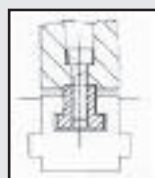

DANGER
T-nut too tall;
bottoms in top
jaw slot, so
serrations not
fully engaged.

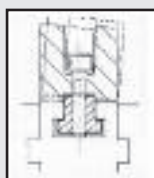

DANGER
Bolt too long;
bottoms in T-slot
so serrations not
fully engaged.
Jaw can tilt.

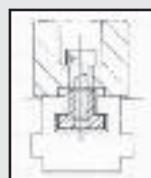

DANGER
Incorrect T-nut
width; does not
locate in base jaw
or in slot of top
jaw.

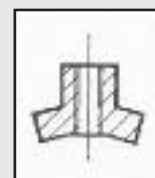

DANGER
T-nut strained;
REPLACE
IMMEDIATELY.

If you have any other points you are uncertain about please call our sales office and we will be pleased to be of assistance.